

RUGGLES™

PRODUCT CATALOG

Innovations. For Life.

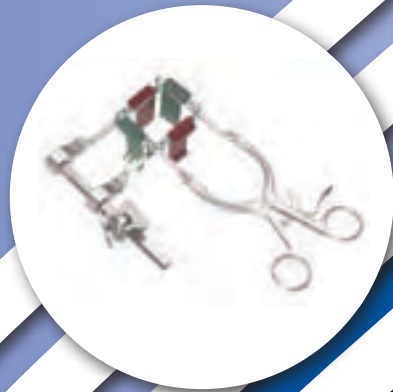

 **INTEGRA™**

Ordering and Warranty Information	ii
Policies, Procedures, Care and Handling of Ruggles™ Instruments	iii-vi

Ruggles™	1-226
-----------------	--------------

1. Access Instrumentation	1-30
2. Retractors	31-78
3. Rongeurs, Kerrisons, and IVD's	79-120
4. Curettes	121-142
5. Suction Tubes	143-154
6. Operational Instrumentation	155-172
7. Microsurgical Instrumentation	173-214
8. Instrument Trays	215-226
9. Indexes	227-250
Alphabetical Index	229-233
Numerical Index	234-244
Products Not CE Marked Alphabetical Index and Numerical Index	245
Conversion Scales	246-247
Measuring an Instrument Guidelines	248-250

Ordering and Warranty Information

Pricing:

Prices stated in specific written quotations are firm for thirty days from the date given, and are otherwise subject to change without prior notice. Pricing terms stated on written agreements are governed by such agreements.

Minimum Order Requirements:

Minimum order requirement is \$100 (a \$10 handling charge will be added to any order under \$100). For partial case orders, contact the Customer Service Department for quotation.

Shipments:

F.O.B. Integra NeuroSciences point of shipment within the continental United States. Shipping costs (including freight and insurance), shall be prepaid by Integra NeuroSciences and invoiced to customers.

Ordering Procedure:

A written purchase order on customer's form may be requested for purchases of Integra NeuroSciences products.

Acceptance of Orders:

Orders are accepted upon approval by Integra NeuroSciences in Plainsboro, New Jersey.

Bonding Service:

Upon customer request, screws can be bonded in certain instruments. For details about our bonding service, please contact your Integra NeuroSpecialist representative or the customer service department.

Integra NeuroSciences Limited Warranty

INTEGRA NEUROSCIENCES warrants that each new INTEGRA NEUROSCIENCES product is free from defects in material and workmanship under normal use and service for a period of two (2) years (except as otherwise expressly provided as to accessory items) from the date of delivery by INTEGRA NEUROSCIENCES to the first purchaser, but not beyond the "Expiration" date stated on any product labeling. Surgical instruments are guaranteed to be free from defects in material and workmanship when used normally for their intended purpose. Any covered product which is placed by INTEGRA NEUROSCIENCES under a lease, rental or installment purchase agreement and which requires repair service during the term of such placement agreement shall be repaired in accordance with the terms of such agreement. If any such defect occurs during the warranty period or term of such placement agreement, the purchaser should communicate directly with the INTEGRA NEUROSCIENCES' home office. If returned to INTEGRA NEUROSCIENCES at its home office, repair or replacement will be carried out at INTEGRA NEUROSCIENCES' sole discretion, at INTEGRA NEUROSCIENCES' expense, subject to the terms of this warranty and applicable agreements. The defective product should be returned promptly, properly packaged and postage prepaid. Loss or damage in return shipment to INTEGRA NEUROSCIENCES shall be at CUSTOMER's risk.

IN NO EVENT SHALL INTEGRA NEUROSCIENCES BE LIABLE FOR ANY INCIDENTAL, INDIRECT, CONSEQUENTIAL OR PUNITIVE DAMAGES IN CONNECTION WITH THE ACQUISITION OR USE OF ANY INTEGRA NEUROSCIENCES PRODUCT. Further, this warranty shall not apply to, and INTEGRA NEUROSCIENCES shall not be responsible for, any loss arising in connection with the purchase or use of any INTEGRA NEUROSCIENCES product which has been repaired by anyone other than an authorized INTEGRA NEUROSCIENCES service representative or altered in any way so as, in INTEGRA NEUROSCIENCES' judgment, to affect its stability or reliability, or which has been subject to misuse, negligence or accident, or which has been used otherwise than in accordance with the instructions furnished by INTEGRA NEUROSCIENCES. THIS LIMITED WARRANTY IS EXCLUSIVE AND IN LIEU OF ALL OTHER WARRANTIES, EXPRESS OR IMPLIED, AND OF ALL OTHER OBLIGATIONS OR LIABILITIES ON INTEGRA NEUROSCIENCES' PART, AND INTEGRA NEUROSCIENCES NEITHER ASSUMES NOR AUTHORIZES ANY REPRESENTATIVE OR OTHER PERSON TO ASSUME FOR IT ANY OTHER LIABILITY IN CONNECTION WITH INTEGRA NEUROSCIENCES' PRODUCTS.

INTEGRA NEUROSCIENCES DISCLAIMS ALL OTHER WARRANTIES, EXPRESS OR IMPLIED INCLUDING ANY IMPLIED WARRANTY OF MERCHANTABILITY OR OF FITNESS FOR A PARTICULAR PURPOSE OR APPLICATION OR WARRANTY OF QUALITY, OTHER THAN THOSE EXPRESSLY SET FORTH IN THE PRODUCT LABELING, INCLUDING THE APPLICABLE USER INFORMATION. The foregoing shall not relieve INTEGRA NEUROSCIENCES from strict tort liability, if otherwise applicable under governing law, for damages for personal injury caused by a product defect that made the product unreasonably dangerous at the time it was sold or placed.

Return Policy:

- Authorization, from customer service, must be obtained prior to returning product.
- Sterile product must be returned in unopened, undamaged cartons, packed to prevent damage.
- Non-sterile product must be returned in unused saleable condition in original package.
- Custom or special order products will not be accepted for credit.
- Credit will be issued for goods returned prior to ninety days from ship date with a 20% restocking charge. This assumes that the product returned is not damaged and can be verified to have not been used or opened.

Customer Service Contact Information

311 Enterprise Drive
Plainsboro, New Jersey 08536 USA

USA and Canada

800-654-2873
609-275-0500 (outside the USA)
609-275-5363 (Fax)

England

+44 (0) 1264 345 700
+44 (0) 1264 332 113 (Fax)

France

+33 (0) 493 95 56 00
+33 (0) 493 95 56 60 (Fax)

Germany

0800 10 10 755
06995 775 477 (Fax)

Product Description:

Integra NeuroSciences' surgical instruments are designed to perform a specific function, such as cutting, grasping, clamping, dissecting, probing, retracting, draining, aspirating, suturing, or ligating. The use of an instrument for a task other than that for which it is intended, as well as improper, ineffective and insufficient maintenance can greatly reduce the life of an instrument and will invalidate the instrument's warranty.

How Supplied:

Integra NeuroSciences' instruments are supplied non-sterile and must be cleaned, lubricated and sterilized prior to use according to hospital protocol and the procedures outlined in this document. Failure to follow these procedures will invalidate the instrument's warranty and can cause the instrument to fail.

Instrument Care and Handling:

Every hospital owns many thousands of dollars worth of surgical instruments. The care and maintenance that these instruments receive is critical to their performance during surgery and to the cost containment efforts of the hospital. With consistent and proper technique during the use, care, and handling of these surgical instruments, the hospital can expect several years of use from its investment in these quality products.

Manufacture:

Metallurgical research has enabled instrument makers to produce accurate, long-lasting surgical instruments. The steel used in most O.R. instruments is a 400 series alloy which has several useful properties. It can be brought to a very sharp cutting edge and will hold this edge through continuous use. In addition, the high tensile strength enables it to maintain precisely set jaw approximations. The metal is often referred to as stainless because of its corrosion resistance qualities. A chromium content ranging from 11.5% to 18% gives the steel some of its stainless characteristics. During manufacturing, a surface layer of chromium oxide begins to develop on the instrument and provides the instrument with corrosion resistance properties. Through routine hospital use and exposure to the air this oxidation process continues, effectively maintaining and even building up a barrier to most stains and corrosive elements.

General Use:

All RUGGLES instruments are carefully inspected before shipment. Because damage may occur during transit, the instruments should be thoroughly inspected upon receipt and prior to use.

Indications for Use:

For use by, or as directed by, a surgeon. Instruments should be used only for the purpose for which they are designed. The proper surgical technique for the use of instruments is the responsibility of the surgeon.

Handling and Operating Instruments:

RUGGLES instruments should be handled and operated by personnel completely familiar with their use, assembly and disassembly. Before a new instrument is used and prior to each surgical procedure the instrument must be decontaminated, lubricated and sterilized as described below. Handle the instrument with care. The instrument must be inspected to assure proper functioning prior to each use with particular attention paid to the condition

of all moving parts, tips, box locks, ratchets and cutting edges. Each instrument with a screw must be inspected before and after use to ensure that the screws do not move when operating the instrument. Screws can loosen and back out of an instrument as a result of normal operation and/or the vibration during ultrasonic cleaning. Failure to make a complete inspection to assure the proper operation and function of the instrument may result in unsatisfactory performance, perhaps because a part is missing. Do not use if the instrument does not appear to be functioning properly. Use of an instrument for a task other than that for which it is intended could result in a damaged or broken instrument, or one which provides an unsatisfactory performance. In order to insure RUGGLES warranties and guarantees, contact Integra customer service for information repair.

Precautions:

For electrosurgical instruments, use the least amount of power appropriate for the application. For electrosurgical cables, disconnect from the generator or instrument by grasping the connector only. Do not pull the cable by the cord. Do not use instrument or cable if insulation is not fully intact.

DECONTAMINATION AND STERILIZATION PROCEDURES

As with any decontamination procedure, personnel should follow accepted guidelines for hand washing, the use of protective attire, etc. as recommended by A.A.M.I. Standards and Recommended Practice, "Safe Handling and Biological Decontamination of Medical Devices in Health Care Facilities and in Non-Clinical Settings", ANSI/AAMI ST35:2003.

INSTRUMENTS

A. MANUAL DECONTAMINATION:

Decontamination is a two step process. First step – thorough cleaning. Second step – sterilization or disinfection.

PRECLEANING:

Remove gross debris from surgical instruments with a lap sponge and sterile water during the procedure to prevent drying on of blood and body fluids, etc.

CLEANING:

To prevent the formation of biofilm, cleaning should occur as soon as possible after instrumentation is used. Biofilm is an accumulation of a biomass of bacteria and extracellular material that tightly adheres itself to the surface of the instruments. It cannot be easily removed, and protects microorganisms from being easily removed by ordinary cleaning/decontamination methods used in hospitals. It is particularly problematic in lumened medical devices.

Step 1.

Maintain moisture: Immediately after the surgical procedure, place the instruments in an instrument tray/container and cover with a towel moistened with sterile distilled water. Foam, spray or gel products, specifically intended for use with surgical instruments, are available to keep the soil moist. Transport tray of soiled instruments in an impervious plastic bag or

Policies, Procedures, Care and Handling

container to the decontamination environment (keep the outside of the containment clean).

Step 2.

Enzymatic Soak: Immerse fully opened and/or disassembled instruments in an enzymatic solution, specific for use with surgical instruments. Prepare the solution and use per enzyme manufacturer's recommendations, paying special attention to instructions for correct dilution, temperature and soak time. Flush air from lumens and fill them with enzymatic solution for full contact with this inner surface during the soak time.

Step 3.

Rinse: Remove from enzymatic soak after the time period recommended by the enzymatic manufacturer and rinse thoroughly with tap water. Flush lumens until rinse water runs clear.

Step 4.

Clean Instruments: Choose a cleaning solution appropriate for surgical instruments, and follow the manufacturer's instructions for use. The ideal cleaning agent is nonabrasive, low-foaming and free-rinsing. Using a small clean hand-held brush, remove soil from all surfaces of the instrument, while fully immersed in the solution. Remove the soil from the ratchets, jaws, tips, box locks, and/or hinge mechanism. Clean the shank or shaft of the instrument by wiping with a soft cloth such as a disposable lap sponge. Use a clean soft bristled brush to flush instruments with an accessible channel. Vigorously flush channels with the cleaning solution.

Step 5.

Rinse: Thoroughly rinse instruments by immersing in tap water and wiping with a clean, soft cloth. Flush lumens until water runs clear.

Step 6.

Ultrasonic Cleaning and Rinsing: Follow the recommendations of the ultrasonic manufacturer regarding cycle times, detergents, proper placement of the instrument tray, and conditioning ("degassing") of the cleaning solution, etc. Use an ultrasonic cleaner to remove soil from hard to reach surfaces such as grooves, crevices, lumens, instruments with moving parts, etc., after gross soil has been removed by previous cleaning process. Open or disassemble instruments as appropriate. Place instruments in a mesh bottom stainless steel instrument tray. Place the tray into the ultrasonic cleaner. Flush air out of lumens and fill them with the ultrasonic cleaning solution (under the solution level in the chamber) for effective removal of soil from that inner surface, by the ultrasonic activity. **After ultrasonic cleaning and rinsing, check screws on instruments because the vibration from the ultrasonic cleaning may cause them to loosen or fall out.**

Step 7.

Final rinse should be with "treated water". Softened or deionized water should be used for the final rinse to better remove detergents, etc. Softening water removes calcium and magnesium ions that cause water to be hard. Iron ions may also be removed by this treatment. Deionization removes ionized salts and particles from the water. Excessively hard water can spot or stain instruments and excessive chlorine in water can cause pitting of the instrument.

Step 8.

Decontaminate Clean Instruments: Once instruments have been cleaned they must be rendered safe for handling, inspection and assembly. They may be steam sterilized without a wrapper or disinfected following the instructions from the instrument, sterilizer and disinfectant manufacturers.

Step 9.

Visual Inspection and Instrument Set Assembly: Visually inspect the instrument for cleanliness and be sure all parts are in proper working order, as the set is assembled.

Step 10.

Lubricate: The use of an instrument lubricant, that is compatible with the method of sterilization to be used, is recommended before instruments are sterilized. Be certain that the instrument lubricant is diluted and maintained properly for dipping or spraying on, according to the manufacturer's instructions. Lubricants that are too concentrated or too heavily applied will result in slippery instruments that will also be mistaken as wet after sterilization. Proper application of lubricants to clean joints will keep them moving freely and aid in protecting the surface from mineral deposits. **Note that ultrasonic cleaners remove all lubrication; therefore this maintenance procedure should be done routinely after ultrasonic cleaning and before sterilization.**

Step 11.

Prepare instrument sets for sterilization using a wrapper, pouch or rigid sterilization container that is appropriate for the method of sterilization to be used.

B. MECHANICAL DECONTAMINATION:

RUGGLES surgical instrumentation may be processed in a washer sterilizer or washer decontaminator/disinfecter. Some of these processes include an enzyme application phase and a lubrication phase that is designed into the cycle. Check with a Customer Service representative for questions regarding processing duplicate, complex, and/or multipart instruments by this method.

C. TERMINAL STERILIZATION

After following the decontamination recommendations, RUGGLES reusable instruments are ready for sterilization. Independent laboratory testing, conducted according to the F.D.A. (21 CFR PART 58) and Good Laboratory Practice Regulations (G.L.P.), has validated steam sterilization as an effective process for RUGGLES reusable instruments. Contact Integra Customer Service for Sterilization parameters.

Steam sterilization of lumened instruments requires that they be flushed with sterile water just prior to wrapping and sterilization. The water generates steam within the lumen to move air out. Air is the greatest enemy to steam sterilization, preventing steam contact if not eliminated.

Medical device manufacturer's exposure times to sterilization temperature may need to be longer than the minimum indicated by the sterilizer manufacturer but must never be shorter.

Each user shall consult individual national infection control/prevention protocols for specific guidance regarding processing medical devices with suspected exposure to Creutzfeldt-Jakob Disease.

MAINTENANCE PROCEDURES

Designed and crafted to exacting specifications, instruments will perform for a reasonable number of years when the following steps are observed:

Proper Use:

Instruments should be used during surgery exclusively for their intended purpose. Misusing instruments will lead to damage that is usually not repairable; for example, a hemostat that is used to clamp tubing can become misaligned and quickly break.

Protect Instruments:

- The use of neutral pH detergents is vital to the maintenance of surgical instruments. Contact with acidic or alkaline solution will remove the instruments' protective barrier of chromium oxide, often leading to corrosion, pitting and breakage.
- Certain compounds are highly corrosive to stainless steel and will cause serious damage despite the passivated protective surface.

If instruments are inadvertently exposed to any of the following substances, they should be rinsed immediately with copious amounts of water.

Instruments should never be exposed to:

Aqua regia	Iodine
Ferric chloride	Sulfuric acid
Hydrochloric acid	

The following substances should be avoided whenever possible:

Aluminum chloride	Mercury chloride
Barium chloride	Potassium permanganate
Bichloride of mercury	Potassium thiocyanate
Calcium chloride	Saline
Carbolic acid	Sodium hypochlorite
Chlorinated lime	Stannous chloride
Dakin's solution	

- The use of an instrument lubricant, compatible with the sterilization method to be used, is an integral step in maintaining the long-life of the surgical instrument. Lubrication will prevent the friction of metal on metal and preserve the smooth function of the instrument thus avoiding corrosion by friction. Furthermore, routine use of lubricating agents on thoroughly clean instruments will prevent hinged and other movable parts from sticking. Lubrication will aid in protecting the entire instrument surface from mineral deposits.
- During manual cleaning, never use steel wool, wire brushes, scalpel blades or highly abrasive detergent cleansers to remove soil from surgical instruments. These will damage the instruments' protective surface and lead to corrosion.
- Any kind of corrosion will lead to rust on steel. Because rust particles can be transferred from one instrument to another, corroding instruments should be removed from service to prevent the formation of rust on other instruments.

Instruments must be sterilized in the open position or disassembled as appropriate. **Steam will only sterilize the surface it can directly touch.**

- Every effort should be made to protect sharp cutting edges and fine working tips during all maintenance procedures. Avoid loading retractors and other heavy items on top of delicate and hollow instruments.

Cleaning:

- Before first use, all instruments must be thoroughly decontaminated prior to sterilization to remove any factory soil.
- It is important to rinse instruments that have been exposed to blood and saline solution before these substances dry. Blood and body fluids as well as saline solutions are highly corrosive. In addition, blood can produce a stain that is difficult to remove. Instruments should be wiped clean with a lap sponge moistened with sterile water routinely during a procedure. They should be kept moist immediately following use, either by placing in an appropriate basin of sterile distilled water or covered with a moist towel. Instruments should not be transported in liquid.
- When cleaning instruments, it is important to use a detergent that is appropriate for surgical instruments. A neutral pH detergent, as near 7.0, as possible is preferred. You may find that depending on the type of soil, a detergent that is a little more or less acid or alkaline may be more appropriate. Distilled water is recommended because it is free of the many compounds which exist in ordinary tap water. These substances, alone, cause stains and when tap water is combined with some detergents it will form insoluble deposits on the instruments. Manual cleaning will be most effective with a solution of luke warm water and a neutral pH detergent. This should be followed by a two stage rinse. The first rinse removes detergent and soil. The final "treated water" rinse removes any residues and minerals from the surface of the instruments
- The box lock and hinge portion of an instrument must be thoroughly cleaned after each use. A build-up of soil, debris, lubricants, etc., in these areas, will make it difficult to use the instrument and eventually irreparably damage it. Manual cleaning should remove all visible residue. It is essential to keep the box locks and hinges open during any manual or automated cleaning process.
- Follow the manufacturer's specifications when using automatic washer-sterilizers or washer decontaminators/disinfectors. They usually require the use of a low foaming, free rinsing detergent with a neutral pH (7.0). A high-foaming detergent may clean effectively but will often leave residual deposits on the instruments and do harm to mechanical washers.
- Automated washer sterilizers and washer decontaminator/disinfectors usually have adjustable wash and rinse times. Some washers enable the user to customize extra cycles to process heavily soiled surgical instruments more effectively.

(continue on next page)

MAINTENANCE PROCEDURES

Drying:

- Before instruments are wrapped for sterilization or storage, they must be thoroughly dry. If a set of instruments is wet when wrapped for sterilization it is likely to come out of the sterilizer wet. "Wet Packs" are not suitable for use after sterilization because they may be easily contaminated when handled. In addition, remaining moisture, particularly in box locks and hinges may result in corrosion that will weaken the instrument and lead to breakage during use.
- The Association for the Advancement of Medical Instrumentation (AAMI) and individual sterilizer manufacturers provide guidance for the proper preparation of surgical instrument trays for sterilization. Some sterilizer manufacturers can also provide information regarding wet pack problem solving. See also, *Sterilization for the Healthcare Facility*, 2nd Edition, Reichert, M.; Young, J., "Wet Pack Problem Solving", Lee, S. (Frederick, MD: Aspen, 1997).

Inspection:

Inspection is a vital part of proper care and maintenance. Instruments in need of repair will not perform accurately in surgery and breakage is likely to occur. DO NOT USE damaged instruments. Worn ratchets, loose box locks and misaligned jaws can be repaired at a fraction of the cost of new instruments. Contact your local Integra Neurosciences representative for information regarding a cost-effective instrument repair program.

Diagnosing Spots and Stains:

It is common for instruments to become stained or spotted despite the best efforts of the manufacturers and the hospital staff. In nearly all cases these problems are the result of minerals deposited upon the surfaces of the instruments, as well as insufficient cleaning. Adhering to proper technique during cleaning and sterilizing procedures will prevent most staining occurrences. However, they will sometimes arise very suddenly and will not disappear on their own. The following identifies the various instrument-related problems hospitals may encounter.

Brown Stains:

Detergents containing polyphosphates may dissolve copper elements in the sterilizer. This results in copper being deposited on the instruments by an electrolytic reaction. The hospital may try a different detergent or check the quantities used. Usually a dull blue or brown stain is simply a build-up of oxidation on the surface. This film is harmless and will actually protect the instrument from serious corrosion.

Blue Stains:

Blue stains are usually the result of cold sterilization techniques. It is important to prepare the solution according to exact proportions and to change the solution when recommended. Serious corrosion may occur if the solution is used beyond the manufacturer's specified time limit. The use of distilled water and a rust inhibitor in the solution will help retard discoloration.

Black Stains:

Black stains may be the result of contact with ammonia. Many cleaning compounds contain ammonia and it will remain on the instruments unless they are well rinsed.

Light or Dark Spots:

Spots are often the result of condensation pooling and then drying on flat and concave instrument surfaces. The mineral content of the water remains on the instrument. Using "treated water" as the FINAL rinse will help to remove the minerals found in water that can cause these residual spots. It is also important to follow the sterilizer manufacturer's instructions for preparing instrument sets for sterilization. Standing instruments that have flat and concave surfaces "on edge" will enable the condensate to drain off and more readily dry, usually without spotting. An additional cause of spotting can be traced to the instrument wraps. During laundering procedures it is vital that detergents are thoroughly rinsed out, and that the final rinse is prepared so that the wraps have a pH between 6.8 and 7.0. In addition, healthcare professionals should check the cleanliness of the sterilizer chamber. Steam can lift soil and poorly rinsed chamber cleaning detergents from the chamber walls and deposit them onto instruments and wrappers.

Rust Deposits:

It is very unlikely for surgical grade steel to rust. What appears to be rust is often residual organic matter in box locks or mineral deposits which have been baked onto the surface of the instrument. In localities where the water has a high iron content, for example, an iron deposit will result in a metallic film on the instrument. This is may be prevented with the use of "treated water" for the FINAL rinse during cleaning procedures.

NOTE:

The limited warranty will not be applicable if the instruments are continually exposed to acidic solutions with a pH of 5 or lower, or alkaline solutions with a pH of 9 or higher.

The most effective method of dealing with instrument problems is to prevent them from occurring. The use of "treated water", careful preliminary cleaning, neutralized pH solutions, manufacturers' instructions, and visual inspection, will help to keep instruments performing accurately and cosmetically free of troublesome stains. It is important to act quickly should a problem arise. Delay will compound the problem and irreparable harm may result.

ACCESS INSTRUMENTATION



ACCESS INSTRUMENTATION

Cranial Burrs and Drills

RUGGLES™ Cushing Perforator Drill

Length	Width	Catalog #
4" (102mm)	3/8" (10mm)	R0010
4" (102mm)	1/2" (13mm)	R0015
4" (102mm)	5/8" (16mm)	R0020



RUGGLES™ Cushing Burr

Length	Width	Catalog #
3 1/2" (89mm)	3/8" (10mm)	R0025
3 1/2" (89mm)	9/16" (14mm)	R0030
3 1/2" (89mm)	13/16" (21mm)	R0035



RUGGLES™ Hudson Burr

Length	Width	Catalog #
4" (102mm)	3/8" (10mm)	R0040
4" (102mm)	9/16" (14mm)	R0041
4" (102mm)	5/8" (16mm)	R0042
4" (102mm)	7/8" (22mm)	R0043



Cranial Burrs and Drills

RUGGLES™ McKenzie Perforator Drill

<u>Length</u>	<u>Width</u>	<u>Catalog #</u>
4" (102mm)	1/2" (13mm)	R0060



R0060

RUGGLES™ McKenzie Enlarger Burr

<u>Length</u>	<u>Width</u>	<u>Catalog #</u>
4" (102mm)	11/16" (17mm)	R0065



R0065

RUGGLES™ D'Errico Perforator Drill

<u>Length</u>	<u>Width</u>	<u>Catalog #</u>
3 3/8" (86mm)	5/8" (16mm)	R0070



R0070

RUGGLES™ Hudson Extension

<u>Length</u>	<u>Catalog #</u>
4" (102mm)	R0080



R0080



Cranial Burrs and Drills

RUGGLES™ Hudson Brace

	Length	Catalog #
Thumb Screw Lock	9 3/4" (248mm)	R0075
Snap Lock	9 3/4" (248mm)	R0076



RUGGLES™ Hudson Cranial Drill Set

R0085 Includes: one (1) Hudson Brace
 one (1) Hudson Extension
 four (4) Hudson Burrs
 R0040, R0041, R0042, R0043

RUGGLES™ Bunnel Hand Drill with Jacobs Chuck

Takes standard twist drills

Length	Diameter	Catalog #
6 1/2" (165mm)	3/8" (10mm)	R0088



Gigli Saws

RUGGLES™ Gigli Saw Handle

1 Pair

	Length	Catalog #
Loop Handle	1 3/4" (44mm)	RN0074
Solid "T" Handle	2" (51mm)	RN0075



RN0074



RN0075

RUGGLES™ Strully-Gigli Saw Handle

Blade Lock, 1 Pair

The Strully-Gigli saw handles have a quick and easy locking device which prevents disengagement of the saw blade from the handle.

	Length	Catalog #
Loop Handle	3 3/4" (95mm)	RN0076
Solid "T" Handle	3 3/4" (95mm)	RN0077



RN0076



RN0077

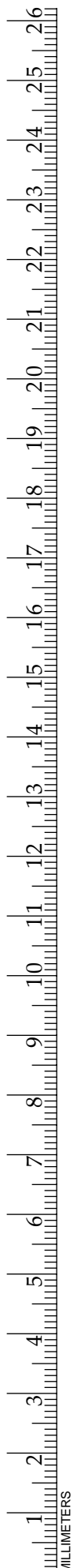

Gigli Saws

RUGGLES™ Gigli Saw Blade

Length **Catalog #**

9" (229mm)	RN0070
12" (305mm)	RN0071
20" (508mm)	RN0072
30" (762mm)	RN0073

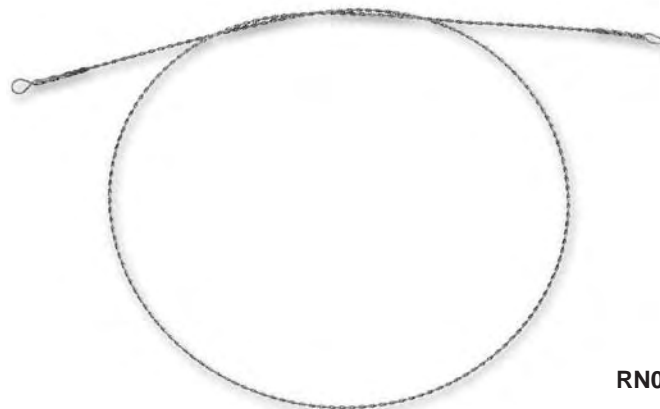

RN0072

RUGGLES™ Gigli Saw Guide

Length **Catalog #**

Straight	12" (305mm)	RN0061
Curved	12" (305mm)	RN0062



RN0062

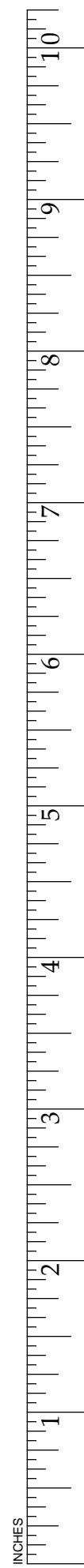

Knives and Retinaculotomes

RUGGLES™ Crille Ganglion Knife

Length Catalog #

8 1/2" (216mm) R0250



R0250

RUGGLES™ Early Spinal Fusion Knife

Length Catalog #

9" (229mm) R0515



R0515

RUGGLES™ Paine's Carpal Tunnel Retinaculotome

Catalog #

R0520



R0520

RUGGLES™ Retinaculotome

Catalog #

R0521



R0521

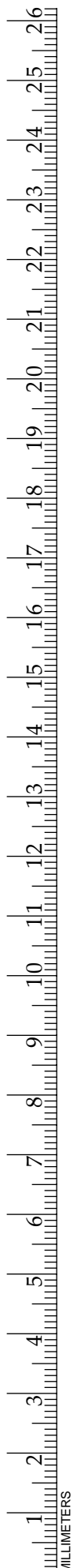

RUGGLES™ Adson Dura Hook

	<u>Length</u>	<u>Catalog #</u>
Blunt	7 3/4" (197mm)	RN0121
Sharp	7 3/4" (197mm)	RN0120



RN0120

RUGGLES™ Sachs Dura Hook

	<u>Length</u>	<u>Catalog #</u>
	6" (152mm)	R0200



R0200

RUGGLES™ Cushing Dura Hook

	<u>Length</u>	<u>Catalog #</u>
	5 1/2" (140mm)	R0205



R0205



Dura Hooks

RUGGLES™ Frazier Dura Hook

Length Catalog #

5" (127mm) R0210



R0210

RUGGLES™ Lahey Clinic Dura Hook

Length Catalog #

5 1/4" (133mm) R0212



R0212

RUGGLES™ Strully Dura Twist Hook

The Strully Dura Twist Hook is a simple and effective means of catching and holding the dura. The hook is placed against the dura and a half turn seats the point in the dura securely with little effort. The hook is used in a comfortable vertical plane which is particularly useful when approaching the dura through a small defect.

Length Catalog #

6" (152mm) R0215



R0215

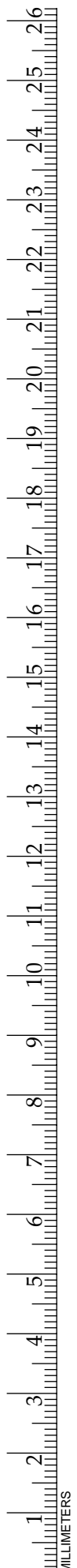

Nerve Hooks

RUGGLES™ Dandy Nerve Hook



R0862

	Length	Catalog #
Straight	9" (229mm)	R0860
Left	9" (229mm)	R0861
Right	9" (229mm)	R0862

RUGGLES™ Hoen Nerve Hook



RN0123

	Length	Catalog #
Straight	9 1/4" (235mm)	RN0123
Angled	9 1/4" (235mm)	RN0124



RN0124

RUGGLES™ Murphy Ball Hook



R0848

Diameter	Length	Catalog #
2mm	8" (203mm)	R0848
2mm	9" (229mm)	RN0128



Dura Separators

RUGGLES™ Sachs Dura Separator and Guard

Length Catalog #

8 1/2" (216mm) R0225



R0225

RUGGLES™ Dorsey Dura Separator

Groove Length Catalog #

5mm 6" (152mm) R0231



R0231

RUGGLES™ Double Ended Dura Separator

Groove Length Catalog #

5mm 5 1/2" (140mm) R0233



R0233

RUGGLES™ Hoen Dura Separator

Length Catalog #

45° 6" (152mm) R0235

90° 6" (152mm) R0236



R0235



R-0236



Dura Separators

RUGGLES™ Horsley Dura Separator and Guard

	Length	Catalog #
Angled	7" (178mm)	R0248



RUGGLES™ Sachs Dura Separator

Blade	Length	Catalog #
1/4" x 3/4" (6 x 19mm)	8 3/4" (222mm)	RN0210



RUGGLES™ Frazier Dura Separator

Blade	Length	Catalog #
Tapered	6 1/2" (165mm)	RN0211



Dura Dissectors and Elevators

RUGGLES™ Olivecrona Double Ended Dissector



R0177

	Length	Catalog #
Heavy	7" (178mm)	R0175
Light	7" (178mm)	R0176
Heavy	9 1/2" (241mm)	R0177
Light	9 1/2" (241mm)	R0178

RUGGLES™ Davis Nerve Separator and Spatula



R0240

	Length	Catalog #
Semi-Sharp	7 3/4" (197mm)	R0240

RUGGLES™ Freer Elevator



R0243

	Length	Catalog #
Sharp/Blunt Full Curve	8 1/4" (210mm)	R0243

RUGGLES™ Freer Double Ended Dissector



R0244

Length	Catalog #
8" (203mm)	R0244

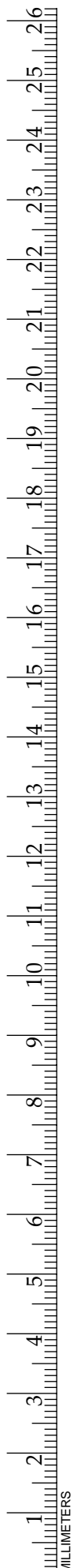

RUGGLES™ Sachs Nerve Separator and Spatula



	<u>Length</u>	<u>Catalog #</u>	R0245
Slender	7 3/4" (197mm)	R0245	

RUGGLES™ Presbyterian Hospital Staphylorrhaphy Elevator



	<u>Length</u>	<u>Catalog #</u>	R0247
Straight	7" (178mm)	R0246	
Curved	7" (178mm)	R0247	

RUGGLES™ Davis Spatula



	<u>Length</u>	<u>Catalog #</u>	R0252
	6 1/4" (159mm)	R0252	

RUGGLES™ Double Ended Dissector



	<u>Length</u>	<u>Catalog #</u>	R0259
	8 1/2" (216mm)	RN0410	
	8 3/4" (222mm)	R0259	



Periosteal Instruments

RUGGLES™ Penfield Dura Dissector

Style **Catalog #**

#1 RN0401

#2 RN0402

#3 RN0403

#4 RN0404

#5 RN0405



RN0401



RN0402



RN0403



RN0404



RN0405



RUGGLES™ Woodson Elevator and Spatula



RN0222

Length	Catalog #
--------	-----------

10" (254mm)	RN0222
-------------	--------

RUGGLES™ Woodson Elevator



R0265

Length	Catalog #
--------	-----------

7 1/4" (184mm)	R0265
----------------	-------

RUGGLES™ Woodson Dura Separator and Packer



R0266

Length	Catalog #
--------	-----------

6 3/4" (171mm)	R0266
----------------	-------

7" (178mm)	RN0413
------------	--------

RUGGLES™ Woodson Double Ended Packer



R0267

Length	Catalog #
--------	-----------

6 3/4" (171mm)	R0267
----------------	-------

RUGGLES™ Oldberg Dissector



R0268

Length	Catalog #
--------	-----------

7 3/4" (197mm)	R0268
----------------	-------



Periosteal Elevators

RUGGLES™ Adson Elevator

Length 6 1/2" (165mm)

Style		Catalog #
#1	Sharp, Straight Edge	R0260
#2	Curved, Semi-Sharp	R0261
#3	Curved, Blunt	R0262
#4	Straight, Semi-Sharp	R0263



R0260



R0261



R0262



R0263

RUGGLES™ Love-Adson Elevator

Length	Catalog #
--------	-----------

6 1/2" (165mm)	R0295
----------------	-------



R0295

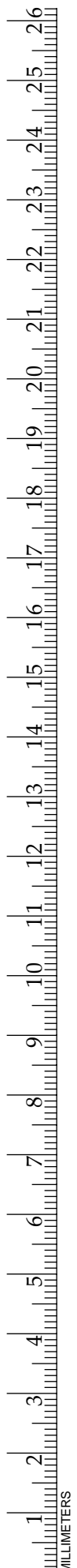

Periosteal Elevators

RUGGLES™ Cushing Periosteal Elevator



R0291



R0290



R0289

	Length	Catalog #
Round Edge, Serrated	7 1/4" (184mm)	R0289
Round Edge, Sharp	7 1/4" (184mm)	R0290
Square Edge, Sharp	7 1/4" (184mm)	R0291

RUGGLES™ Cushing Periosteal Elevator



R0285

	Length	Catalog #
Left	8" (203mm)	R0285
Right	8" (203mm)	R0286

RUGGLES™ Cushing Little Joker

Length	Catalog #
6" (152mm)	R0256
7 1/2" (191mm)	RN0506



R-0256



Periosteal Elevators

RUGGLES™ Joseph Periosteal Elevator

Length **Catalog #**

6 1/2" (165mm) **R0269**



R0269

RUGGLES™ Key Periosteal Elevator

Length **Width** **Catalog #**

7 1/2" (191mm) 1/8" (3mm) **R0270**

7 1/2" (191mm) 1/4" (6mm) **R0271**

7 1/2" (191mm) 3/8" (10mm) **R0272**

7 1/2" (191mm) 1/2" (13mm) **R0273**

7 1/2" (191mm) 5/8" (16mm) **R0274**

7 1/2" (191mm) 3/4" (19mm) **R0275**

7 1/2" (191mm) 1" (25mm) **R0276**



Side view, close-up of R-0271



R0271



R0272



R0273



R0275



R0276



Periosteal Elevators

RUGGLES™ Hoen Periosteal Elevator



R0278

Length	Width	Catalog #
7" (178mm)	3/8" (10mm)	R0277
7" (178mm)	11/16" (17mm)	R0278
7" (178mm)	13/16" (21mm)	R0279

RUGGLES™ Langenbeck Periosteal Elevator

	Catalog #
Narrow	R0280
Wide	R0281



R0280



R0281

RUGGLES™ Sedillot Elevator

Length	Catalog #
7 1/2" (191mm)	R0287



R0287

RUGGLES™ Ballenger Septum Elevator

Length	Catalog #
7 3/4" (197mm)	RN0335



RN0335



Periosteal Elevators

RUGGLES™ Fukushima–Gianotta Periosteal Elevator

Catalog

Flat **R8957**
1/2" (13mm) Blade



R8957

RUGGLES™ John Day Periosteal Elevator

Cup

Catalog

6mm Straight	R8906
6mm Angled with Cup	R8907
6mm Angled 1cm from Cup	R8908
12mm Straight	R8909



12mm

R-8909



6mm

R8906

RUGGLES™ T. Fukushima Periosteal Elevator

Adson Type



R8913

	Width	Length	Catalog #
Slight Curve	7mm	7 1/8" (200mm)	R8914
Regular Curve	7mm	7 1/8" (200mm)	R8915
Modified Langenbeck	13mm	7 7/8" (200mm)	R8913



R8914



R8915



Dural and Spinal Elevators

RUGGLES™ T. Fukushima Dural Elevator and Spatula



Catalog #

Double Ended	R8911
Double Ended, Reduced	R8912

RUGGLES™ Cobb Spinal Elevator

Length	Width	Catalog #
11" (279mm)	3/8" (10mm)	R0294
11" (279mm)	1/2" (13mm)	R0296
11" (279mm)	3/4" (19mm)	R0297
11" (279mm)	1" (25mm)	R0298
11" (279mm)	1 1/4" (32mm)	R0299



Side view, close-up of R0294



Osteotomes

RUGGLES™ Lambotte Osteotome Straight

Length	Width	Catalog #
9" (229mm)	1/4" (6mm)	R2200
9" (229mm)	1/2" (13mm)	R2201
9" (229mm)	3/4" (19mm)	R2202
9" (229mm)	1" (25mm)	R2203
9" (229mm)	1 1/4" (32mm)	R2204
9" (229mm)	1 1/2" (38mm)	R2205

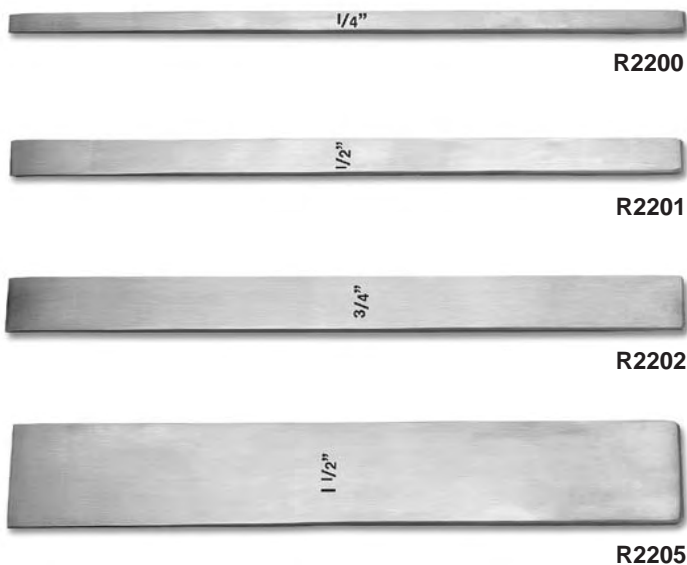

RUGGLES™ Lambotte Osteotome Curved

Length	Width	Catalog #
9" (229mm)	1/4" (6mm)	R2210
9" (229mm)	1/2" (13mm)	R2211
9" (229mm)	3/4" (19mm)	R2212
9" (229mm)	1" (25mm)	R2213
9" (229mm)	1 1/4" (32mm)	R2214
9" (229mm)	1 1/2" (38mm)	R2215

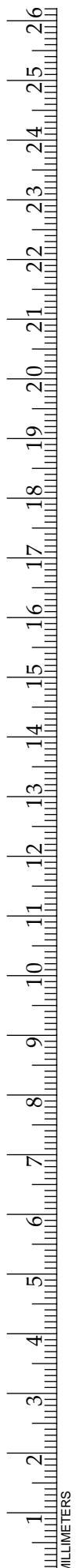
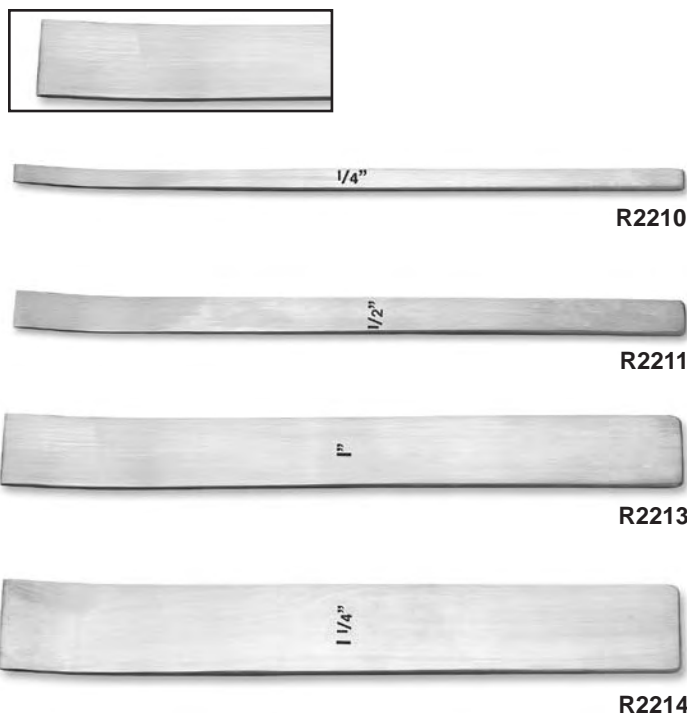

RUGGLES™ Smith–Peterson Osteotome

Straight

Length	Width	Catalog #
8" (203mm)	1/4" (6mm)	R0300
8" (203mm)	3/8" (10mm)	R0301
8" (203mm)	1/2" (13mm)	R0302
8" (203mm)	5/8" (15mm)	R0303
8" (203mm)	3/4" (19mm)	R0304
8" (203mm)	1" (25mm)	R0305
8" (203mm)	1 1/4" (32mm)	R0306



R0305

Curved

Length	Width	Catalog #
8" (203mm)	1/4" (6mm)	R0310
8" (203mm)	3/8" (10mm)	R0311
8" (203mm)	1/2" (13mm)	R0312
8" (203mm)	5/8" (15mm)	R0313
8" (203mm)	3/4" (19mm)	R0314
8" (203mm)	1" (25mm)	R0315
8" (203mm)	1 1/4" (32mm)	R0316



R0315



Gouges

RUGGLES™ Smith-Peterson Gouge

Straight

Length	Width	Catalog #
8" (203mm)	1/4" (6mm)	R2260
8" (203mm)	3/8" (10mm)	R2261
8" (203mm)	1/2" (13mm)	R2262
8" (203mm)	5/8" (15mm)	R2263
8" (203mm)	3/4" (19mm)	R2264
8" (203mm)	1" (25mm)	R2265
8" (203mm)	1 1/4" (32mm)	R2266



Curved

Length	Width	Catalog #
8" (203mm)	1/4" (6mm)	R2270
8" (203mm)	3/8" (10mm)	R2271
8" (203mm)	1/2" (13mm)	R2272
8" (203mm)	5/8" (15mm)	R2273
8" (203mm)	3/4" (19mm)	R2274
8" (203mm)	1" (25mm)	R2275
8" (203mm)	1 1/4" (38mm)	R2276

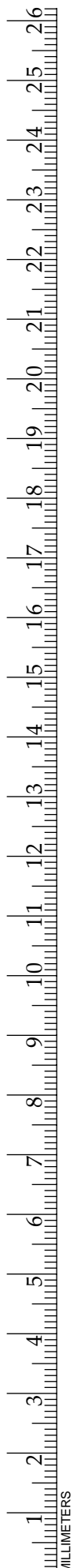

Gouges

RUGGLES™ Cobb Type Gouge

Blade 1/4" (6mm)

	Length	Catalog #
Straight	11" (279mm)	R2240
Medium Curve	11" (279mm)	R2241
Strong Curve	11" (279mm)	R2242
Reverse Curve	11" (279mm)	R2243



Bone Graft Impactors

RUGGLES™ Long Bone Graft Impactor, Length 14" (356mm)

Width **Catalog #**

12mm **R12168**

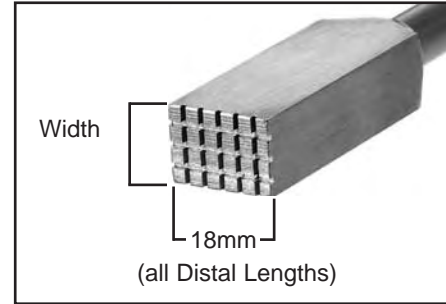

8mm **R12164**



9mm **R12165**



10mm **R12166**



11mm **R12167**



12mm **R12168**



13mm **R12169**



14mm **R12170**



15mm **R12171**

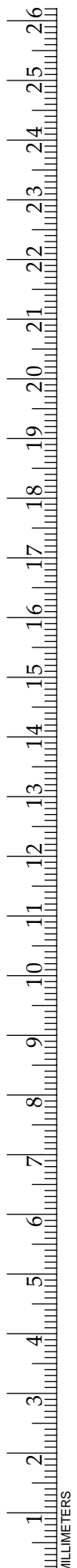

RUGGLES™ Lumbar and Cervical Impactor

	Tip Size	Length	Catalog #
Standard Guarded	7 x 12.5mm	8 1/2" (216mm)	R6540
Standard	7 x 12.5mm	8 1/2" (216mm)	R6541
Wide Guarded	10 x 13mm	8 1/2" (216mm)	R6542
Wide	10 x 13mm	8 1/2" (216mm)	R6543
Offset	6.5 x 11.5mm	8 1/2" (216mm)	R6544
Angled	6.5 x 16mm	8 1/2" (216mm)	R6545
Narrow	6.5 x 12.5mm	8 1/2" (216mm)	R6546
Micro, Offset	4.3 x 10mm	7" (178mm)	R6547
Micro, Lateral	4.3 x 10mm	7" (178mm)	R6548



Dura Scissors

RUGGLES™ Taylor Dura Scissors

Length Catalog #

5 3/4" (146mm) RN7214



RN7214

RUGGLES™ Frazier Dura Scissors

Length Catalog #

6 1/2" (165mm) RN7217



RN7217

RUGGLES™ Dandy Trigeminal Scissors

Length Catalog #

6 3/4" (171mm) RN7218

7 3/4" (197mm) RN7219



RN7219

RUGGLES™ Raney Clip Applying Forceps

Length Catalog #

6 1/4" (159mm) RN0140

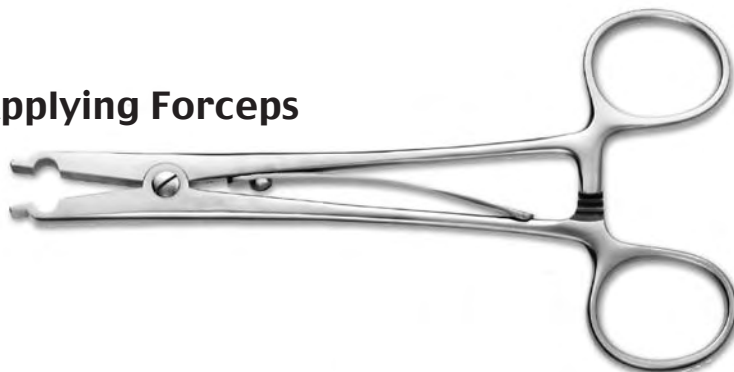

RN0140



RETRACTORS



RETRACTORS

Vertebral Body Distraction System

RUGGLES™ ACF Complete System with Sterilization Tray

Catalog #

R6000

RUGGLES™ Drill Guide

Catalog #

Left R6388



RUGGLES™ Distractor

Catalog #

Single Level, Left R6387

RUGGLES™ Distractor

Catalog #

Multiple Level, Left R6389

RUGGLES™ Screwdriver

Catalog #

R6396



RUGGLES™ Twist Drill

Catalog #

R9395



Vertebral Body Distraction System

RUGGLES™ Drill Guide

Catalog #

Right

R6393



R6393



R6392



R6394

RUGGLES™ Distractor

Catalog #

Single Level, Right

R6392

RUGGLES™ Distractor

Catalog #

Multiple Level, Right

R6394

RUGGLES™ Distraction Screws



R-6397A

Non-Sterile

Catalog #

12mm Individual RN2877

14mm Individual RN2878

16mm Individual RN2879

Sterile

Catalog #

12mm Individual R6367A

14mm Individual R6398A

16mm Individual R6397A

Anterior Cervical Fusion Tray

Catalog #

R6298



Anterior Cervical Fusion (ACF) Retraction System

RUGGLES™ Transverse Retractor Body

Catalog #

R6312

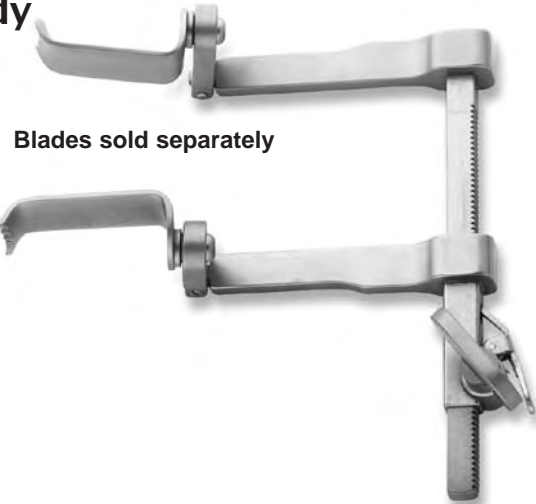

Blades sold separately

R6312

Transverse Retractor Set

Includes: Transverse Body
5 Medium Length Medial Blades
5 Medium Length Lateral Blades

Catalog #

R6380

RUGGLES™ Longitudinal Retractor Body

Catalog #

R6313



Blades sold separately

R6313

Longitudinal Retractor Set

Includes: Longitudinal Body
5 Medium Length Longitudinal Blades

Catalog #

R6386

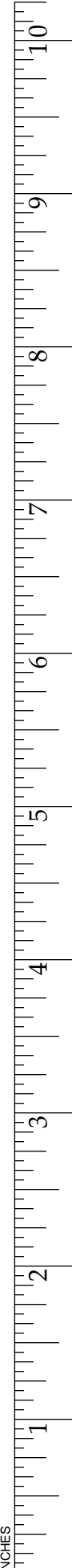

Anterior Cervical Fusion (ACF) Retraction System

RUGGLES™ Medial Retractor Blades, Ball Snap



R6559

Short Length	Catalog #	Medium Length	Catalog #	Long Length	Catalog #
25 x 23mm	R6555	40 x 23mm	R6370	65 x 23mm	R6558
30 x 23mm	R6556	45 x 23mm	R6371	70 x 23mm	R6559
35 x 23mm	R6557	50 x 23mm	R6372		
		55 x 23mm	R6373		
		60 x 23mm	R6374		

RUGGLES™ Longitudinal Retractor Blades, Ball Snap



R6554

Short Length	Catalog #	Medium Length	Catalog #	Long Length	Catalog #
30 x 23mm	R6550	45 x 23mm	R6381	70 x 23mm	R6553
35 x 23mm	R6551	50 x 23mm	R6382	75 x 23mm	R6554
40 x 23mm	R6552	55 x 23mm	R6383		
		60 x 23mm	R6384		
		65 x 23mm	R6385		



Anterior Cervical Fusion (ACF) Retraction System

RUGGLES™ Lateral Retractor Blades, Ball Snap



R6564

Short Length	Catalog #	Medium Length	Catalog #	Long Length	Catalog #
25 x 23mm	R6560	40 x 23mm	R6375	65 x 23mm	R6563
30 x 23mm	R6561	45 x 23mm	R6376	70 x 23mm	R6564
35 x 23mm	R6562	50 x 23mm	R6377		
		55 x 23mm	R6378		
		60 x 23mm	R6379		

RUGGLES™ Fenestrated Iliac Blades, Ball Snap

	Catalog #
50 x 23mm	R6320
60 x 23mm	R6321



R6321

RUGGLES™ Blade Ejector

Catalog #

R6310



R6310



Anterior Cervical Fusion (ACF) Retraction System

RUGGLES™ Caliper

Length Catalog #

6" (152mm) R6317

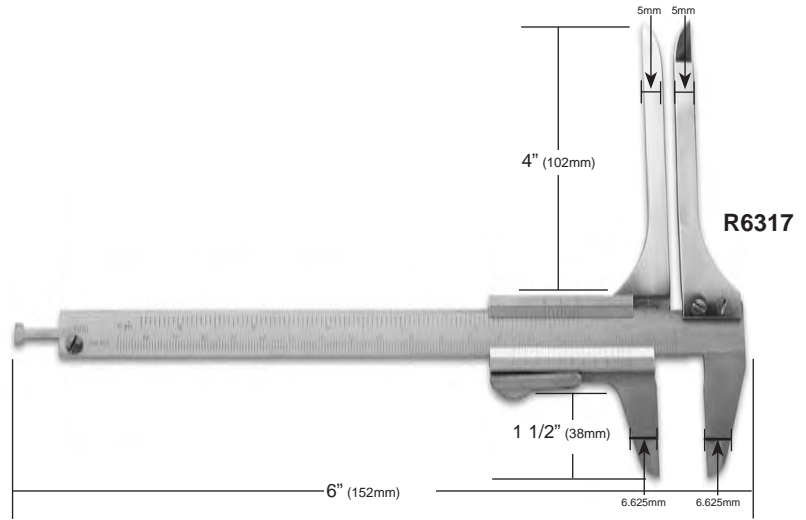

RUGGLES™ Bone Graft Harvesting Forceps

Width Catalog #

9mm R6318

7mm R6319

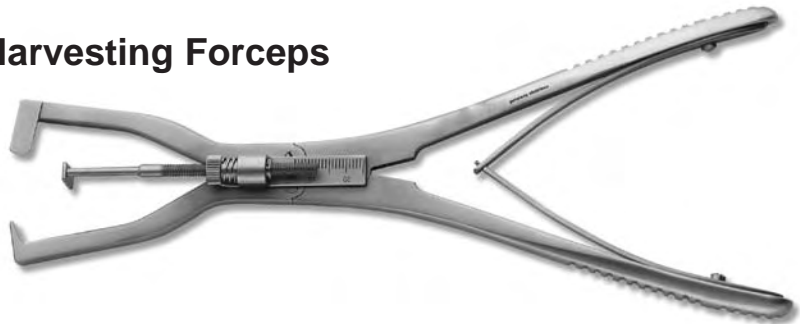

R6318

RUGGLES™ Bone Graft Impactor

Diameter Length Catalog #

3mm 7 3/4" (197mm) R6314

5mm 7 3/4" (197mm) R6315

8mm 7 3/4" (197mm) R6316



R6315

RUGGLES™ Bone Graft Holder

Catalog #

R6399



R6399

RUGGLES™ Vertebral Body Dissector

Catalog #

Small R6390

Large R6391

Micro R6337



R6391

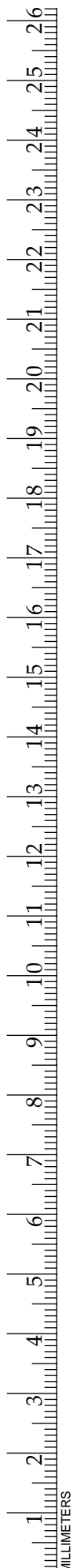

Micro Lumbar Discectomy (MLD) Retraction System

RUGGLES™ MLD Retractor Body

Catalog #

R6405

MLD Retractor Set

Includes: MLD Retractor Body
6 MLD Center Blades

Catalog #

R6406



R6405

RUGGLES™ MLD Center Retractor Blades, Ball Snap

Catalog #

35 x 14mm R6407

40 x 14mm R6408

45x 14mm R6409

50 x 14mm R6410

55 x 14mm R6411

60 x 14mm R6412



R6412

RUGGLES™ Blade Ejector

Catalog #

R6310



R6310



Micro Lumbar Discectomy (MLD) Retraction System

RUGGLES™ Speculum Retractor

Blade Length	Catalog #
40mm	R6413
45mm	R6414
50mm	R6415
55mm	R6416
60mm	R6417
65mm	R6418



R6418



Universal Micro Lumbar Discectomy (UMLD) Retraction System

RUGGLES™ Scoville Retractor Body Double Hinged

Catalog #

R6579



R6579

RUGGLES™ UMLD Retractor Blades

Catalog #

50 x 10mm R6630

60 x 10mm R6631

50 x 20mm R6632

60 x 20mm R6633

65 x 14mm R6601

70 x 14mm R6602

75 x 14mm R6603

80 x 14mm R6604



R6630



R6604

RUGGLES™ Blade Ejector

Catalog #

R6310



R6310

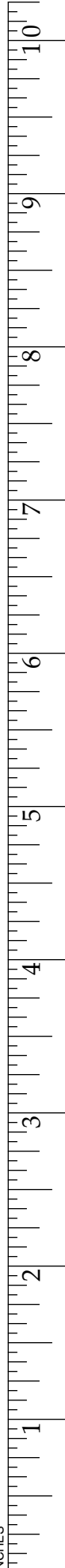

Universal Micro Lumbar Discectomy (UMLD) Retraction System

RUGGLES™ Scoville Blades, Ball Snap

Catalog #

40 x 38mm R6641

67 x 32mm R6644



R6641

RUGGLES™ Taylor Blades, Ball Snap

Catalog #

40 x 51mm R6643

44 x 38mm R6640

63 x 57mm R6642



R6640

RUGGLES™ Hooks, Ball Snap

Catalog #

50mm R6621

60mm R6622



R6621

RUGGLES™ T-Bars, Ball Snap

Catalog #

50mm R6623

60mm R6624



R6623



Flexi-Spine™ Retraction System

RUGGLES™ Flexi-Spine™ Retraction System

Complete set including 2 retractor handles, all blade pairs and hooks, both retractor bodies, and instrument case

Catalog #

RU2400

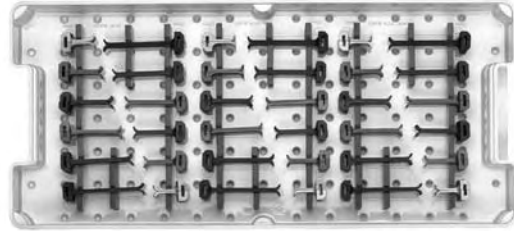

Flexi-Spine™ Instrument Tray

Catalog #

RS2400

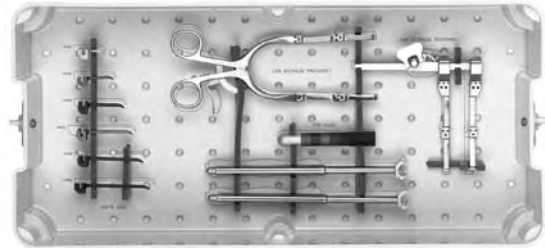

RU2400

Transverse retractor body

Catalog #

RU2408



RU2408

Longitudinal retractor body

Catalog #

RU2409



RU2409

Flexi-Spine™ Depth Gauge

Catalog #

RU2422



RU2422



Flexi-Spine™ Retraction System

Retractor Blade Handle (2 per set)

Catalog

RU2403



RU2403

Short Teeth Blade Set (12 pair) **RU2404**

Catalog #		Catalog #	
15 x 25mm	RU2410	20 x 25mm	RU2416
15 x 35mm	RU2411	20 x 35mm	RU2417
15 x 45mm	RU2412	20 x 45mm	RU2418
15 x 55mm	RU2413	20 x 55mm	RU2419
15 x 65mm	RU2414	20 x 65mm	RU2420
15 x 75mm	RU2415	20 x 75mm	RU2421



Blunt Blade Set (12 pair) **RU2405**

Catalog #		Catalog #	
15 x 25mm	RU2428	20 x 25mm	RU2434
15 x 35mm	RU2429	20 x 35mm	RU2435
15 x 45mm	RU2430	20 x 45mm	RU2436
15 x 55mm	RU2431	20 x 55mm	RU2437
15 x 65mm	RU2432	20 x 65mm	RU2438
15 x 75mm	RU2433	20 x 75mm	RU2439



Long Teeth Blade Set (12 pair) **RU2406**

Catalog #		Catalog #	
15 x 25mm	RU2446	20 x 25mm	RU2452
15 x 35mm	RU2447	20 x 35mm	RU2453
15 x 45mm	RU2448	20 x 45mm	RU2454
15 x 55mm	RU2449	20 x 55mm	RU2455
15 x 65mm	RU2450	20 x 65mm	RU2456
15 x 75mm	RU2451	20 x 75mm	RU2457



Hook Set (6 hooks) **RU2407**

Catalog

18mm	RU2464
28mm	RU2465
38mm	RU2466
48mm	RU2467
58mm	RU2468
68mm	RU2469



RUGGLES™ Spinal Retraction System

RN2800 Ruggles™ Spinal Retraction System

<u>Set Includes:</u>	<u>Catalog #</u>
one (1) Transverse Retractor Body	RN2801
one (1) Longitudinal Retractor Body	RN2802
two (2) Retractor Handles	RN2803
one (1) set (12 pair of blades) Short Teeth Blades	RN28110-RN28121
one (1) set (12 pair of blades) Long Teeth Blades	RN28210-RN28221
one (1) set (12 pair blades) Blunt Blades	RN28310-RN28321
one (1) set (6 hooks) Hooks	RN28410-RN28415
one (1) Instrument Tray	RS2800

Spinal Retraction System



RN2800

Transverse Retractor Body

Length Catalog #

5 1/4" (133mm) RN2801



RN2801

Blades sold separately

Longitudinal Retractor Body

Length Catalog #

8 1/4" (210mm) RN2802



RN2802

Blades sold separately

Retractor Blade Handle

Length Catalog #

7 1/4" (184mm) RN2803



RN2803

Continued on next page



Spinal Retraction System

RUGGLES™ Spinal Retraction System (continued)

Short Teeth Blades (pair)

Catalog #		Catalog #	
15 x 25mm	RN28110	20 x 25mm	RN28116
15 x 35mm	RN28111	20 x 35mm	RN28117
15 x 45mm	RN28112	20 x 45mm	RN28118
15 x 55mm	RN28113	20 x 55mm	RN28119
15 x 65mm	RN28114	20 x 65mm	RN28120
15 x 75mm	RN28115	20 x 75mm	RN28121

Long Teeth Blades (pair)

Catalog #		Catalog #	
15 x 25mm	RN28210	20 x 25mm	RN28216
15 x 35mm	RN28211	20 x 35mm	RN28217
15 x 45mm	RN28212	20 x 45mm	RN28218
15 x 55mm	RN28213	20 x 55mm	RN28219
15 x 65mm	RN28214	20 x 65mm	RN28220
15 x 75mm	RN28215	20 x 75mm	RN28221

Blunt Blades (pair)

Catalog #		Catalog #	
15 x 25mm	RN28310	20 x 25mm	RN28316
15 x 35mm	RN28311	20 x 35mm	RN28317
15 x 45mm	RN28312	20 x 45mm	RN28318
15 x 55mm	RN28313	20 x 55mm	RN28319
15 x 65mm	RN28314	20 x 65mm	RN28320
15 x 75mm	RN28315	20 x 75mm	RN28321

Hooks (each)

Catalog #	
18mm	RN28410
28mm	RN28411
38mm	RN28412
48mm	RN28413
58mm	RN28414
68mm	RN28415

Optional Blades (pair)

not included in set

Catalog #	
30 x 25mm	RN28122
30 x 35mm	RN28123
30 x 45mm	RN28124
30 x 55mm	RN28125
30 x 65mm	RN28126
30 x 75mm	RN28127
Catalog #	
30 x 25mm	RN28222
30 x 35mm	RN28223
30 x 45mm	RN28224
30 x 55mm	RN28225
30 x 65mm	RN28226
30 x 75mm	RN28227
Catalog #	
30 x 25mm	RN28322
30 x 35mm	RN28323
30 x 45mm	RN28324
30 x 55mm	RN28325
30 x 65mm	RN28326
30 x 75mm	RN28327

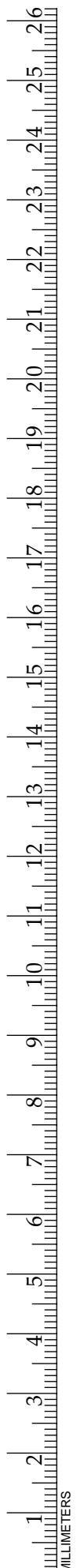

Brain Retractors

RUGGLES™ Silicone Brain Retractor

Clear Reinforced

Post	Body	Catalog #
5cm x 3mm	76 x 9mm	NL7702701
5cm x 3mm	76 x 13mm	NL7702702
5cm x 3mm	76 x 11mm	NL7702703
5cm x 3mm	76 x 22mm	NL7702704
5cm x 3mm	70 x 15mm	NL7702705
5cm x 3mm	95 x 20mm	NL7702707
5cm x 3mm	75 x 25mm	NL7702708

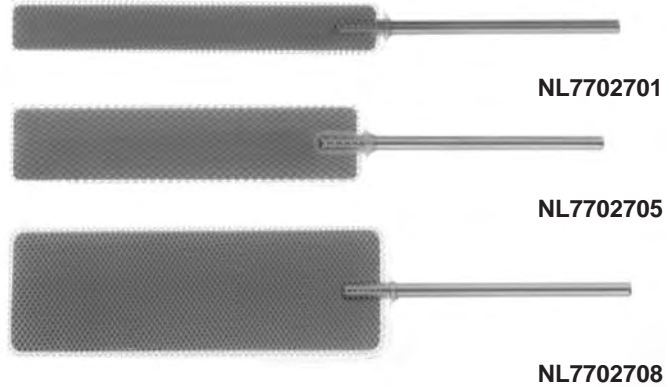

RUGGLES™ Hand-Held Silicone Brain Retractor

Clear Reinforced

Body	Catalog #
1/4" x 8" (6 x 203mm)	NL8700204
3/8" x 8" (10 x 203mm)	NL8700206
1/2" x 8" (13 x 203mm)	NL8700208
5/8" x 8" (16 x 203mm)	NL8700210
7/8" x 8" (22 x 203mm)	NL8700214

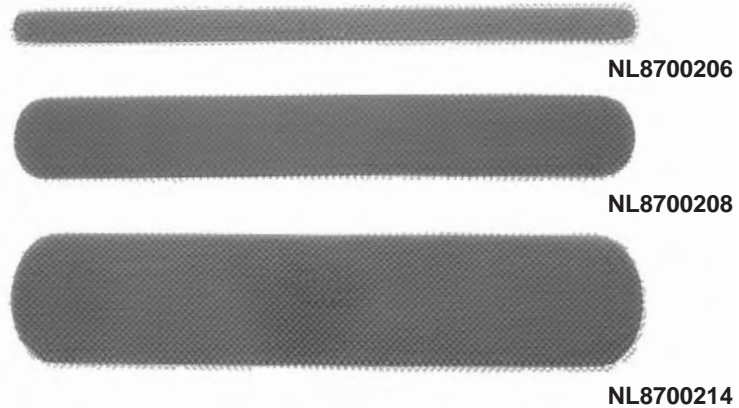

Hand-Held Set (5) NL8700200

Includes one (1) each of items above



Brain Retractors

RUGGLES™ Silicone Brain Retractor

Black

	Tip	Length	Catalog #
Narrow	4mm	6" (152mm)	RN0711N
Wide	8mm	6" (152mm)	RN0711W
Narrow	6mm	6" (152mm)	RN0712N
Wide	13mm	6" (152mm)	RN0712W
Narrow	9mm	6" (152mm)	RN0713N
Wide	18mm	6" (152mm)	RN0713W
Narrow	11mm	6" (152mm)	RN0714N
Wide	23mm	6" (152mm)	RN0714W



RUGGLES™ Hand-Held Silicone Brain Retractor

Black

	Body	Catalog #
Small	8 x 4mm	RN0711
Medium	13 x 6mm	RN0712
Large	18 x 9mm	RN0713
X-Large	23 x 11mm	RN0714

Hand-Held Set (4) RN0710
Includes one (1) each of items above



Brain Spatulas

RUGGLES™ Davis Brain Spatula

Length	Width	Catalog #
7" (178mm)	1/4" (6mm)	R0924
7" (178mm)	3/8" (10mm)	R0925
7" (178mm)	1/2" (13mm)	R0926
7" (178mm)	5/8" (16mm)	R0927
7" (178mm)	3/4" (19mm)	R0928
7" (178mm)	7/8" (22mm)	R0929
7" (178mm)	1" (25mm)	R0930



RUGGLES™ Davis Brain Spatula Kynar Coating

Length	Width	Catalog #
7" (178mm)	1/4" (6mm)	RN0700
7" (178mm)	3/8" (10mm)	RN0701
7" (178mm)	1/2" (13mm)	RN0702
7" (178mm)	5/8" (16mm)	RN0703
7" (178mm)	3/4" (19mm)	RN0704
7" (178mm)	1" (25mm)	RN0705
7" (178mm)	1 1/4" (32mm)	RN0706
7" (178mm)	1 1/2" (38mm)	RN0707



RUGGLES™ Davis Brain Spatula Insulated, Blue Silicone Coating

Post	Body	Catalog #
7" (178mm)	1/4" (6mm)	R0924A
7" (178mm)	3/8" (10mm)	R0925A
7" (178mm)	1/2" (13mm)	R0926A
7" (178mm)	5/8" (16mm)	R0927A
7" (178mm)	3/4" (19mm)	R0928A
7" (178mm)	7/8" (22mm)	R0929A
7" (178mm)	1" (25mm)	R0930A



Brain Spatulas

RUGGLES™ T. Fukushima Brain Spatula

Copper, Ebenol-C Coated

Length	Tip	Catalog #
--------	-----	-----------

8 7/8" (225mm)	Small 2mm	R8959
----------------	-----------	-------

8 7/8" (225mm)	Medium 4mm	R8960
----------------	------------	-------

8 7/8" (225mm)	Large 6mm	R8961
----------------	-----------	-------

8 7/8" (225mm)	X-Large 7mm	R8998
----------------	-------------	-------



R8959



R8960



R8961



R8998

RUGGLES™ T. Fukushima Dura Spatula

Rigid, Stainless Steel

Length	Tip	Catalog #
--------	-----	-----------

8 1/16" (205mm)	Curved 60°	R8962
-----------------	------------	-------

8 1/16" (205mm)	Small 2mm	R8963
-----------------	-----------	-------

8 1/16" (205mm)	Medium 4mm	R8964
-----------------	------------	-------

8 1/16" (205mm)	Large 6mm	R8999
-----------------	-----------	-------

8 1/16" (205mm)	X-Large 7mm	R8979
-----------------	-------------	-------



R8962



R8963



R8964



R8999



R8979

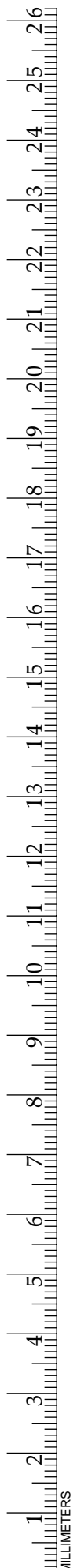

Nerve Root Retractors

RUGGLES™ Scoville Nerve Root Retractor

	Length	Blade Width	Catalog #
Straight	9" (229mm)	1/4" (6mm)	R1000
Angular	9" (229mm)	1/4" (6mm)	R1005



R1000



R1005

RUGGLES™ D'Errico Nerve Root Retractor

	Length	Blade Width	Catalog #
	9" (229mm)	1/4" (6mm)	RN2102



RN2102

RUGGLES™ Martin Nerve Root Retractor

	Length	Blade Width	Catalog #
	8 1/2" (216mm)	1/4" (6mm)	R1007



R1007



Nerve Root Retractors

RUGGLES™ Love Bayonet Nerve Root Retractor

Length	Blade Width	Catalog #
--------	-------------	-----------

8 1/4" (210mm)	4mm	R1024
----------------	-----	-------



R1024

RUGGLES™ Love Nerve Root Retractor

	Length	Blade Width	Catalog #
--	--------	-------------	-----------

90°	7 1/4" (184mm)	1/4" (6mm)	R1025
-----	----------------	------------	-------

45°	7 1/4" (184mm)	1/4" (6mm)	R1026
-----	----------------	------------	-------

Straight	7 1/4" (184mm)	1/4" (6mm)	R1027
----------	----------------	------------	-------

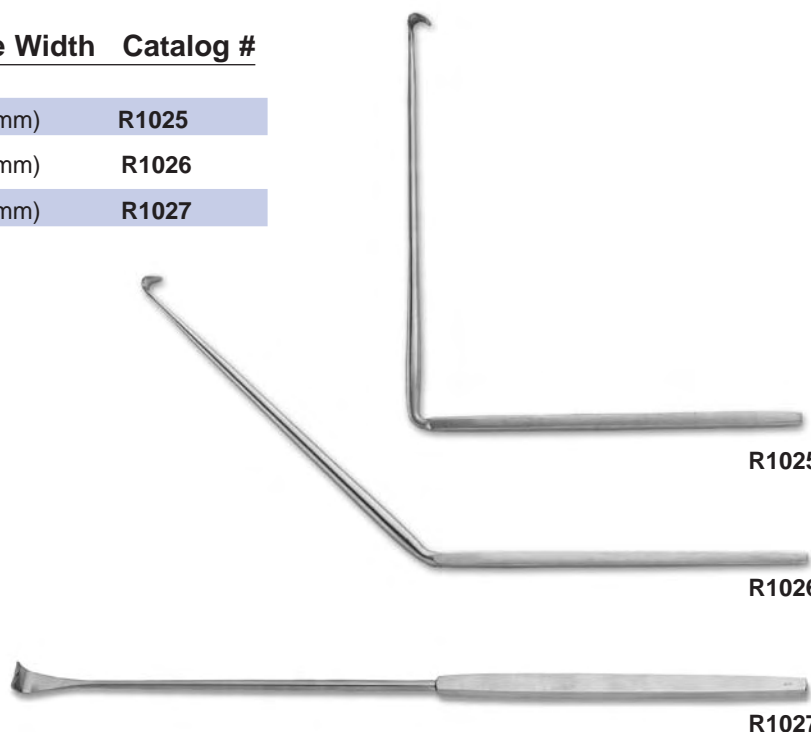

R1025

R1026

R1027

RUGGLES™ Holscher Nerve Root Retractor

Length	Blade Width	Catalog #
--------	-------------	-----------

9 1/2" (241mm)	1/4" (6mm)	RN2104
----------------	------------	--------

9 1/2" (241mm)	1/2" (13mm)	RN2105
----------------	-------------	--------



RN2104

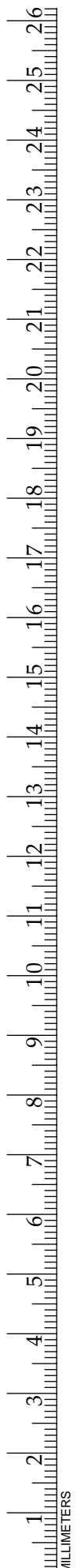

Nerve Root Retractors

RUGGLES™ Nerve Root Retractor

Blade Width	Length	Catalog #
6mm	9 1/2" (240mm)	R6322
8mm	9 1/2" (240mm)	R6323
10mm	9 1/2" (240mm)	R6324

6mm

R6322



8mm

R6323



10mm

R6324



R6324

RUGGLES™ Suction Nerve Retractor

	Blade Width	Length	Catalog #
7Fr	6mm	8" (203mm)	RN2211
7Fr	7mm	8" (203mm)	RN2212
7Fr	8mm	8" (203mm)	RN2213

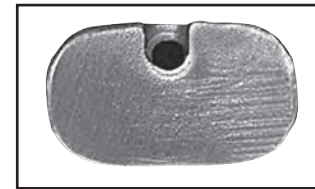
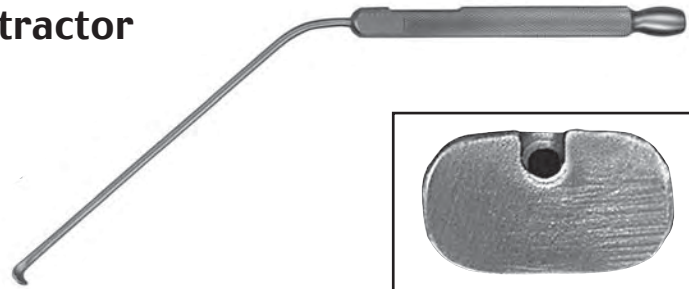

RN2213

Suction Nerve Retractor Set (3) RN2210

Includes one (1) each of items above



Hand-Held Retractors

RUGGLES™ Senn Retractor

Double Ended



	3 Prong Blade	Solid Blade	Length	Catalog #
Sharp	3/8" (10mm)	3/4" x 1/4" (19 x 6mm)	6 1/4" (159mm)	R1297
Blunt	3/8" (10mm)	3/4" x 1/4" (19 x 6mm)	6 1/4" (159mm)	R1298

R1298

RUGGLES™ Volkman Retractor



		Length	Catalog #
2 Prong	Sharp	8 3/4" (222mm)	R1233
3 Prong	Sharp	8 3/4" (222mm)	R1234
4 Prong	Sharp	8 3/4" (222mm)	R1235
6 Prong	Sharp	8 3/4" (222mm)	R1236
2 Prong	Blunt	8 3/4" (222mm)	R1237
3 Prong	Blunt	8 3/4" (222mm)	R1238
4 Prong	Blunt	8 3/4" (222mm)	R1239
6 Prong	Blunt	8 3/4" (222mm)	R1240

R1235

RUGGLES™ Cushing Vein Retractor

Length Catalog #

8 1/2" (216mm) R1095



R1095

RUGGLES™ Cushing Decompression Retractor

Blade Length Catalog #

Fenestrated 8" (203mm) R1100



R1100



Hand-Held Retractors

RUGGLES™ Blade Retractor

Width	Length	Catalog #
18mm	7" (178mm)	R1060
20mm	7" (178mm)	R1061
23mm	7" (178mm)	R1062



R1062

RUGGLES™ Meyerding Retractor

Width	Length	Catalog #
Small 2" x 5/8" (51 x 16mm)	8" (203mm)	R1090
Medium 3" x 1" (76 x 25mm)	8" (203mm)	R1091
Large 3 1/2" x 2" (89 x 51mm)	8" (203mm)	R1092
Small 2" x 5/8" (51 x 16mm)	9" (229mm)	RN2300
Medium 3" x 1" (76 x 25mm)	9 1/2" (240mm)	RN2301
Large 3 1/2" x 2" (89 x 51mm)	9 1/2" (240mm)	RN2302



R1090

RUGGLES™ US Army Retractor

Double Ended, Supplied in Set of 2

Length	Catalog #
8 1/2" (216mm)	R1093



R1093

RUGGLES™ Hibbs Retractor

Blade Width	Length	Catalog #
3" x 1" (76 x 25mm)	9 1/2" (240mm)	R1096



R1093

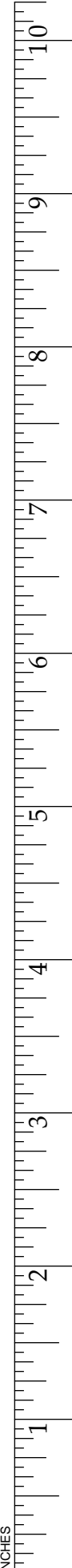

Hand-Held Retractors

RUGGLES™ Taylor Spinal Retractor

Blade Length Catalog #

3" (76mm) 7 1/2" (191mm) **R1080**

4" (102mm) 7 1/2" (191mm) **R1085**



R1080

Blade Length Catalog #

3" x 1 1/4" (76 x 32mm) 7 1/4" (184mm) **RN2320**

4" x 1 1/4" (102 x 32mm) 7 1/4" (184mm) **RN2321**

3" x 3/4" (76 x 19mm) 7 1/4" (184mm) **RN2322**

4" x 3/4" (102 x 19mm) 7 1/4" (184mm) **RN2323**



RN2320



Lamina Spreaders

RUGGLES™ Cervical Vertebra Spreader

R1054

Length Catalog #

5 1/2" (140mm) R1054

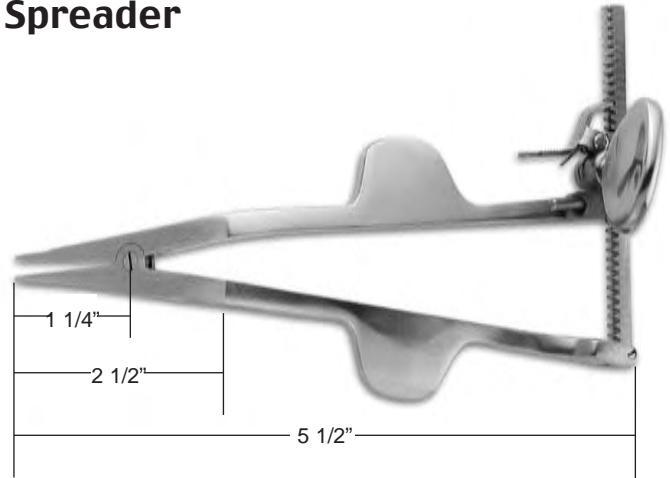

RUGGLES™ Improved Cervical Lamina Spreader

R1050

Length Catalog #

7 1/4" (184mm) R1050

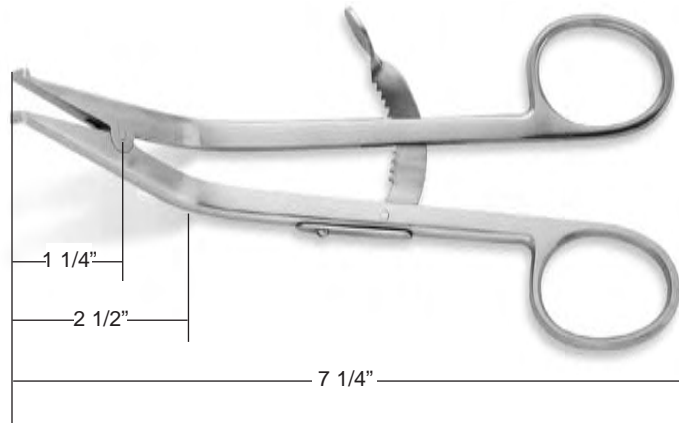

RUGGLES™ Cloward Lamina Spreader

RN2673

Length Catalog #

3/4" Opening 6 1/2" (165mm) RN2673

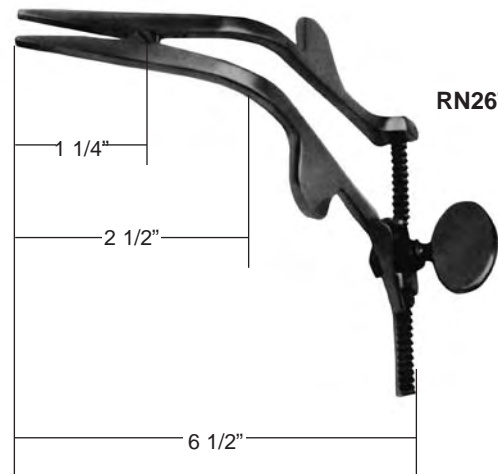

Lamina Spreaders

RUGGLES™ Inge Lamina Spreader

R1070

	Length	Catalog #
Small	6" (152mm)	R1075
Large	9 1/2" (241mm)	R1070

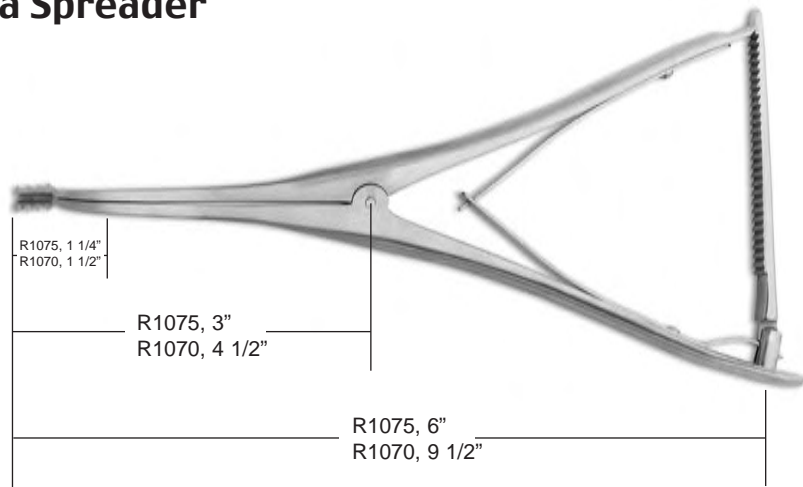

RUGGLES™ Lamina Spreader

2" (51mm) Jaw Opening

	Length	Catalog #
Flat Blades	9 1/2" (241mm)	RN2688
Concave Blades	9 1/2" (241mm)	RN2689

RN2688

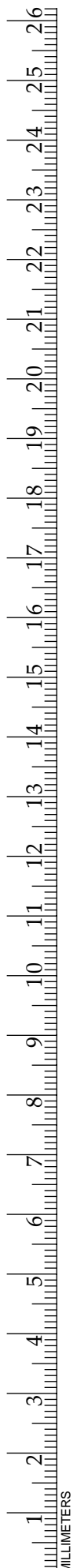
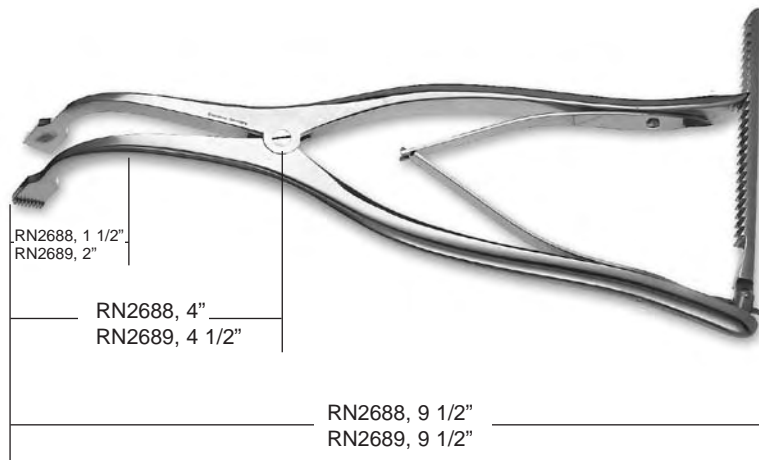

Scalp Retractors

RUGGLES™ Jansen Scalp Retractor

	<u>Length</u>	<u>Catalog #</u>
Blunt	4" (102mm)	R1150
Sharp	4" (102mm)	R1151



R1150

RUGGLES™ Jansen Deep Blade Scalp Retractor

	<u>Length</u>	<u>Catalog #</u>
	4 5/8" (118mm)	R1160



R1160

RUGGLES™ Davis Scalp Retractor

Bayonet

	<u>Length</u>	<u>Catalog #</u>
	4 5/8" (118mm)	R1155



R1155

RUGGLES™ Contour Scalp Retractor

3 x 4 Prongs, Blunt

	<u>Length</u>	<u>Catalog #</u>
	5 1/2" (140mm)	RN2015



RN2015

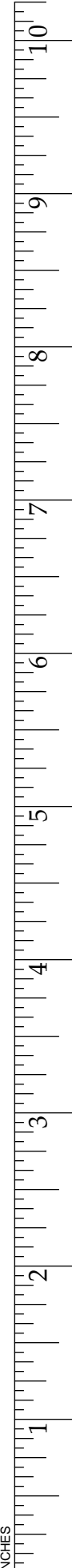

Self-Retaining Retractors

RUGGLES™ Janetta Retractor Set

Includes: one (1) Janetta Body, RN2401
 two (2) Double Round Bars, RN2402
 two (2) Single Round Bars, RN2403
 one (1) each Malleable Blades, RN2404-RN2409

Catalog

RN2400



Janetta Retractor Body

Catalog

RN2401



RN2402



RN2401

RN2403

Janetta Double Round Bar

Catalog

RN2402

Janetta Single Round Bar

Catalog

RN2403

Janetta Malleable Blades

Blade Width	Catalog #
-------------	-----------

70 x 15mm	RN2404
-----------	--------

70 x 20mm	RN2405
-----------	--------

70 x 25mm	RN2406
-----------	--------

95 x 5mm	RN2409
----------	--------

95 x 10mm	RN2407
-----------	--------

95 x 20mm	RN2408
-----------	--------



RN2404



RN2405



RN2406



RN2409



RN2407



RN2408

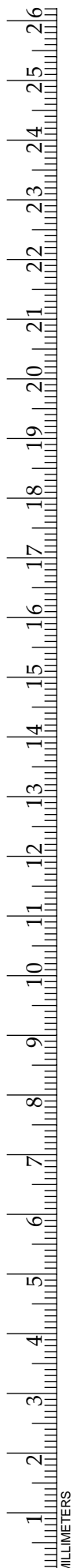

Self-Retaining Retractors

RUGGLES™ Gelpi Retractor

Length **Catalog #**

7 1/2" (191mm) **RN2501**

5 1/2" (140mm) **RN2502**

4 1/2" (114mm) **RN2503**

3 1/2" (89mm) **RN2504**



RN2502

RUGGLES™ Seltz–Gelpi Retractor

Sharp Tips, Bent Arms

Catalog #

RN2506



RN2506

RUGGLES™ Markham–Meyerding Retractor

Length **Catalog #**

Right 25 x 50mm 6 1/2" (165mm) **R1272**

Left 25 x 50mm 6 1/2" (165mm) **R1273**



R1272

RUGGLES™ Meyerding Retractor

Width **Length** **Catalog #**

2 3/8" x 1" (60mm x 25mm) 6 1/2" (165mm) **R1275**

2 1/8" x 1" (54mm x 25mm) 6 1/2" (165mm) **R1280**

1 1/4" x 1" (32mm x 25mm) 6 1/2" (165mm) **R1285**

2 3/8" x 3/4" (60mm x 19mm) 6 1/2" (165mm) **R1290**



R1275



Self-Retaining Retractors

RUGGLES™ Ducker Retractor

	<u>Width</u>	<u>Catalog #</u>
Left	50 x 20mm	RN2721
Right	50 x 20mm	RN2722
Left	70 x 20mm	RN2723
Right	70 x 20mm	RN2724



RN2721

Ducker Retractor Set (4) RN2720
Includes one (1) each of items above

RUGGLES™ Double Ducker Retractor

<u>Width</u>	<u>Catalog #</u>
60 x 21mm	RN27225
73 x 21mm	RN27235



RN27235

RUGGLES™ Deeper Ducker Retractor

<u>Width</u>	<u>Catalog #</u>
90 x 20mm	RN27245



RN27245



Self-Retaining Retractors

RUGGLES™ Williams Style Discectomy Retractor

		Width	Catalog #
Narrow	Left	50 x 10mm	R7250
Narrow	Right	50 x 10mm	R7251
Narrow	Left	60 x 10mm	R7252
Narrow	Right	60 x 10mm	R7253
Narrow	Left	70 x 10mm	R7254
Narrow	Right	70 x 10mm	R7255
Wide	Left	50 x 20mm	R7260
Wide	Right	50 x 20mm	R7261
Wide	Left	60 x 20mm	R7262
Wide	Right	60 x 20mm	R7263
Wide	Left	70 x 20mm	R7264
Wide	Right	70 x 20mm	R7265



R7250



R7261

RUGGLES™ Feler-Ducker Retractor

	Width	Catalog #
Left	50 x 10mm	RN2726
Right	50 x 10mm	RN2727
Left	70 x 10mm	RN2728
Right	70 x 10mm	RN2729
Feler-Ducker Retractor Set (4)		RN2725
Includes one (1) each of items above		



RN2728



Self-Retaining Retractors

RUGGLES™ Weitlaner Self-Retaining Retractor

2 x 3 Prongs

Length Catalog #

Sharp	4" (102mm)	R1220
Blunt	4" (102mm)	R1221

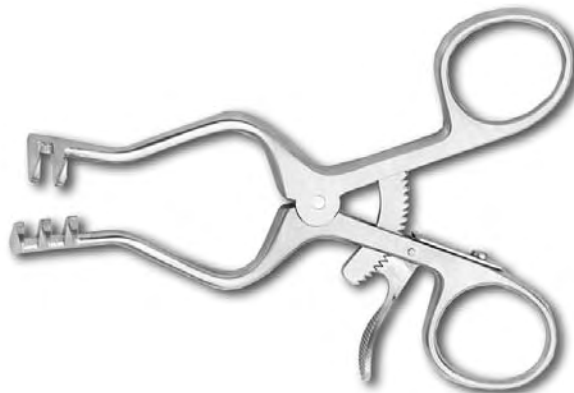

R1220

RUGGLES™ Weitlaner Self-Retaining Retractor

3 x 4 Prongs

Length Catalog #

Sharp	5 1/2" (140mm)	R1200
Blunt	5 1/2" (140mm)	R1201
Sharp	6 1/2" (165mm)	R1205
Blunt	6 1/2" (165mm)	R1206
Sharp	8" (203mm)	R1210
Blunt	8" (203mm)	R1211
Sharp	9 1/2" (241mm)	R1215
Blunt	9 1/2" (241mm)	R1216



R1200



Self-Retaining Retractors

RUGGLES™ Weitlaner Hinged Self-Retaining Retractor

3 x 4 Prongs

	<u>Length</u>	<u>Catalog #</u>
Sharp	5 1/2" (140mm)	R1225
Blunt	5 1/2" (140mm)	R1226
Sharp	6 1/4" (159mm)	R1230
Blunt	6 1/4" (159mm)	R1231
Blunt	8" (203mm)	RN2614

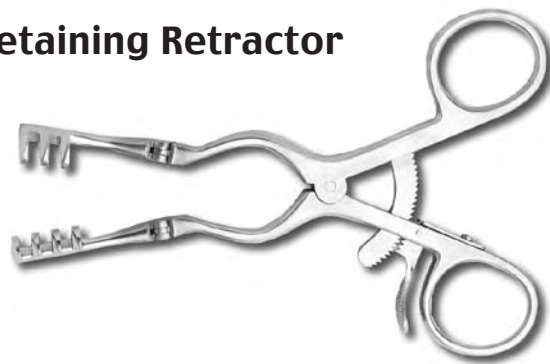

R1225

RUGGLES™ Weitlaner Angled Self-Retaining Retractor

3 x 4 Prongs

	<u>Length</u>	<u>Catalog #</u>
Sharp	6 1/2" (165mm)	R1208
Blunt	6 1/2" (165mm)	R1209
Sharp	9 1/2" (241mm)	R1217
Blunt	9 1/2" (241mm)	R1218

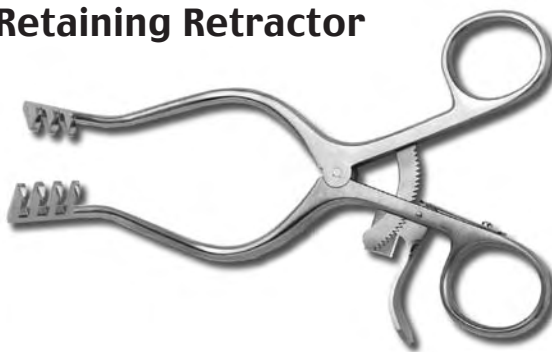

R1208

RUGGLES™ Miskimon Cerebellum Retractor

7 x 7 Prongs, Angled

	<u>Length</u>	<u>Catalog #</u>
Sharp	7 1/2" (191mm)	RN2540



RN2540



Self-Retaining Retractors

RUGGLES™ Adson Cerebella Retractor

	<u>Length</u>	<u>Catalog #</u>
--	---------------	------------------

Blunt	7 1/2" (191mm)	R1189
-------	----------------	-------

Sharp	7 1/2" (191mm)	R1190
-------	----------------	-------

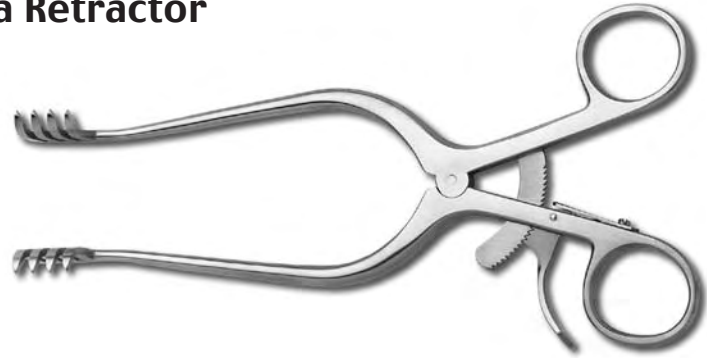

R1190

RUGGLES™ Adson Cerebella Retractor

Angled Arms

	<u>Length</u>	<u>Catalog #</u>
--	---------------	------------------

Blunt	7 1/2" (191mm)	R1194
-------	----------------	-------

Sharp	7 1/2" (191mm)	R1195
-------	----------------	-------



R1194

RUGGLES™ Anderson-Adson Cerebella Retractor

<u>Length</u>	<u>Catalog #</u>
---------------	------------------

8" (203mm)	R1197
------------	-------

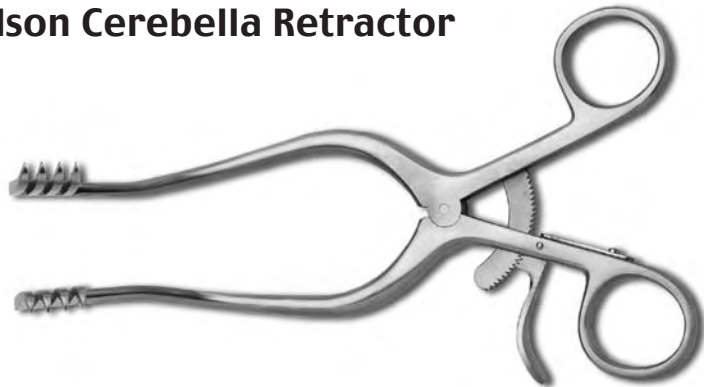

R1197



Self-Retaining Retractors

RUGGLES™ Beckman-Adson Retractor

Hinged Arms, 4 x 4 Prongs

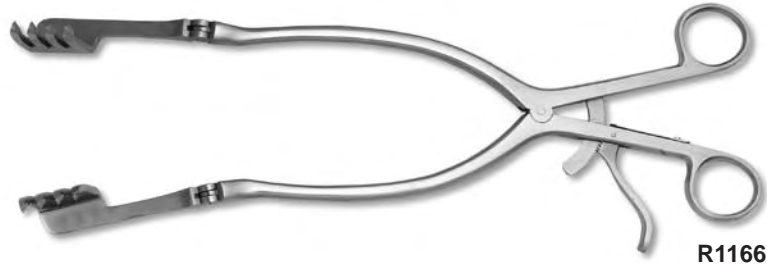

R1166

		Length	Catalog #
Blunt	1" x 1" (25 x 25mm)	12" (305mm)	R1165
Sharp	1" x 1" (25 x 25mm)	12" (305mm)	R1166
Wide, Sharp	1" x 1 3/4" (25 x 44mm)	12" (305mm)	R1170

RUGGLES™ Beckman-Eaton Retractor

Hinged Arms, 7 x 7 Prongs

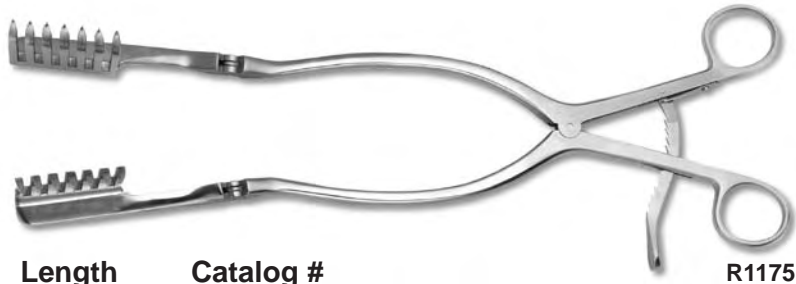

R1175

		Length	Catalog #
Wide, Sharp	2" x 1 3/4" (51 x 44mm)	12 3/4" (324mm)	R1175

RUGGLES™ Oberhill Retractor

4 Prong



RN2528

	Length	Catalog #
1" x 1 1/2" (25 x 38mm)	12" (305mm)	RN2528



Self-Retaining Retractors

RUGGLES™ Hoen Retractor

Body with Two (2) Sets of Blades

Length **Catalog #**

10 3/4" (273mm) **RN2536**

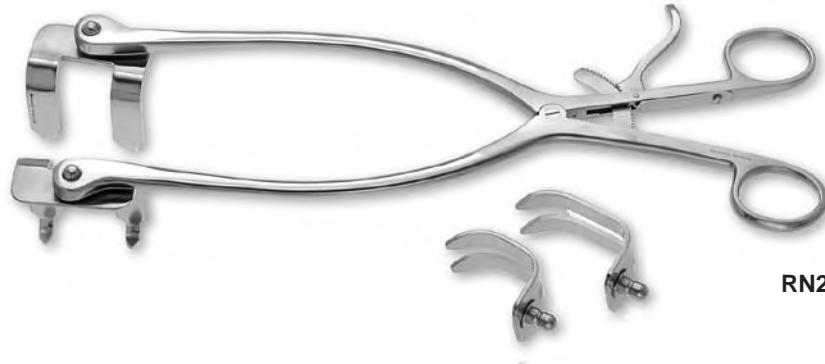

RN2536

RUGGLES™ Micro Discectomy Retractor

Self-Retaining

	Length	Width	Catalog #
Left	6" (152mm)	50 x 10mm	RN2701
Right	6" (152mm)	50 x 10mm	RN2702
Left	6" (152mm)	60 x 10mm	RN2703
Right	6" (152mm)	60 x 10mm	RN2704
Left	6" (152mm)	70 x 10mm	RN2705
Right	6" (152mm)	70 x 10mm	RN2706
Left	6" (152mm)	50 x 20mm	RN2707
Right	6" (152mm)	50 x 20mm	RN2708
Left	6" (152mm)	60 x 20mm	RN2709
Right	6" (152mm)	60 x 20mm	RN2710
Left	6" (152mm)	70 x 20mm	RN2711
Right	6" (152mm)	70 x 20mm	RN2712



RN2701

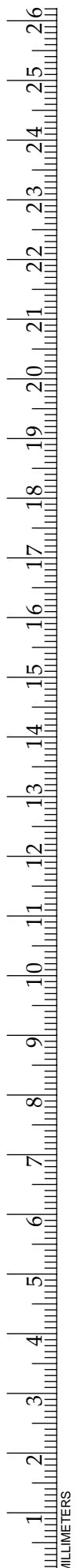

Self-Retaining Retractors

RUGGLES™ Scoville Type Hemilaminectomy Retractor Body

Catalog #

R1106

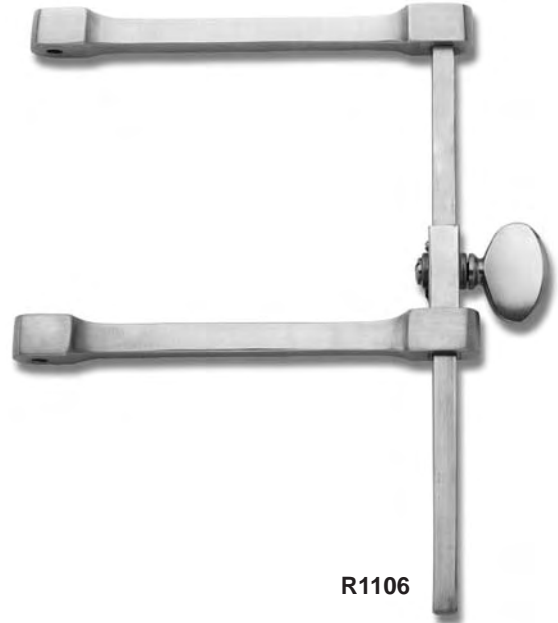

R1106

RUGGLES™

Scoville Haverfield Type Hemilaminectomy Retractor Body

Catalog #

R1111



R1111



Self-Retaining Retractors

RUGGLES™ Scoville Type Hemilaminectomy Hook Blades with Cross Bar



R1113

Length	Catalog #
--------	-----------

2" (51mm)	R1113
3" (76mm)	R1114

RUGGLES™ Scoville Type Hemilaminectomy Hook Blades



R1115

Length	Catalog #
--------	-----------

2" (51mm)	R1115
3" (76mm)	R1116

RUGGLES™ Scoville Type Hemilaminectomy Blades with Teeth



R1118

Length	Width	Catalog #
--------	-------	-----------

2 1/2" (64mm)	1" (25mm)	R1118
2 1/2" (64mm)	2" (51mm)	R1119
2 5/8" (67mm)	1 1/8" (29mm)	R1120
3 1/2" (89mm)	1" (25mm)	R1121

RUGGLES™ Scoville Type Hemilaminectomy Blades with Prongs



R1123

Length	Width	Catalog #
--------	-------	-----------

1 5/8" (40mm)	1 1/2" (38mm)	R1123
2 5/8" (67mm)	1 3/4" (45mm)	R1124

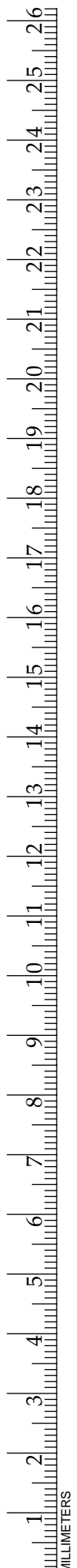

Self-Retaining Retractors

RUGGLES™ Meyerding Type Hemilaminectomy Blades



Length	Width	Catalog #
2 1/4" (57mm)	1" (25mm)	R1126
3" (75mm)	2" (51mm)	R1127
3 1/2" (89mm)	2" (51mm)	R1128

RUGGLES™ Taylor Type Hemilaminectomy Blades Single Tooth



Length	Width	Catalog #
Small, 3" (75mm)	1 1/4" (31mm)	R1130
Large, 4" (102mm)	1 1/4" (31mm)	R1131

RUGGLES™ Hibbs Type Hemilaminectomy Blades with Prongs



Length	Width	Catalog #
2" (51mm)	1" (25mm)	R1134
2" (51mm)	2" (51mm)	R1135
2 1/2" (64mm)	1" (25mm)	R1136
2 1/2" (64mm)	1 1/2" (38mm)	R1137
3" (75mm)	1" (25mm)	R1138
3" (75mm)	1 1/2" (38mm)	R1139



Length	Width	Catalog #
3" (75mm)	2" (51mm)	R1140
3 1/2" (89mm)	1" (25mm)	R1142
3 1/2" (89mm)	1 1/2" (38mm)	R1143
4" (102mm)	1" (25mm)	R1144
4" (102mm)	2" (51mm)	R1145



Self-Retaining Retractors

RUGGLES™ Taylor Type Hemilaminectomy Blades with Prongs

	Length	Width	Catalog #
3 Prong, Small	1 3/4" (45mm)	1 1/2" (38mm)	R1146
4 Prong, Small	1 7/8" (48mm)	2" (51mm)	R1147
4 Prong, Small	2 1/2" (64mm)	2 1/2" (64mm)	R1148
4 Prong, Small	3 1/8" (79mm)	2 1/4" (57mm)	R1149



R1146



Leyla Retraction System

RUGGLES™ Leyla Retraction System

	Catalog #
Two Arms includes one (1) R2397 and two (2) R2400	R2390
Single Arm includes one (1) R2397 and one (1) R2400	R2391

Flexible Snake Arm

	Catalog #
17" (432mm) Stainless Steel	R2400



R2400

Reichert Fixation Base for mounting to the skull

	Catalog #
For mounting 1 Snake Arm	R2396
For mounting 2 Snake Arms	R2397



R2396



R2397



R2389

Overhead Bar Fixation Base

	Catalog #
For mounting 1 Snake Arm	R2389

Spatula Support

	Catalog #
Flat	R2398
Tubular	R2399



R2399



R2398

Continued on next page

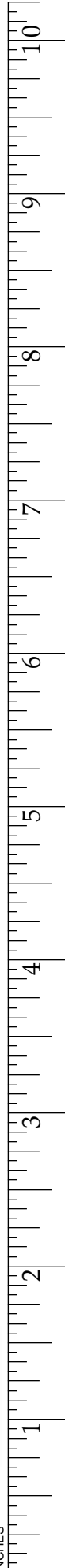

Leyla Retraction System

Continued from previous page

RUGGLES™ Leyla Retraction System

Table Mounting Hardware



R2381



R2382



R2383



R2384

Catalog

Rigid Holding Rod	R2381
Coupling Head	R2382
Ball Joint Clamp	R2383
Coupling Head Turn Table	R2384
Table Mount Set includes one (1) each of items R2381, R2382 and R2383	R2385



Fukushima-Day Retraction System

RUGGLES™ Fukushima-Day Retraction System with Sterilization Case

Includes:	Two (2)	R9101	Table Clamps
	Four (4)	R9102	C-Clamps
	Four (4)	R9103	U-Bars
	Four (4)	R9104	Extension Arms, Adjustable
	Four (4)	R8975	Universal Snake Arms
	One (1)	R9105	Instrument Tray

Catalog

R9100



R9100

Continued on next page

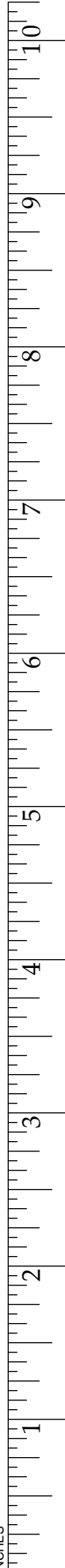

Fukushima-Day Retraction System

Continued from previous page

RUGGLES™ Fukushima-Day Retraction System

Components

Table Clamp

Catalog #

R9101



R9101

Extension Arm, Adjustable

Catalog #

R9104



R9104

C-Clamp

Catalog #

R9102



R9102

Replacement Springs for C-Clamp

Sold Separately (package of 50)

Catalog #

R9106



R9106

U-Bar

Catalog #

R9103



R9103

Fukushima-Day Universal Retraction System Tray (not shown)

Catalog #

R9105



Fukushima-Day Retraction System

RUGGLES™ Retraction System Components

Sold Separately

Scalp Hooks

packs of five

	<u>Catalog #</u>
Small	R8921
Medium	R8922
Large	R8923

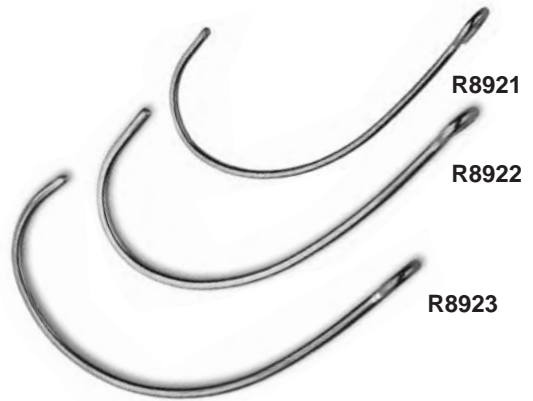

Star Clamp

	<u>Catalog #</u>
2 Point	R8978
3 Point	R8974



R8978



R8974

Universal Snake

Titanium sections, Universal Support

<u>Length</u>	<u>Catalog #</u>
14" (356mm)	R8975

14" (356mm) R8975



R8975



Traction Tongs

RUGGLES™ Gardner–Wells Traction Tongs Set

Catalog

R1945

Includes: one (1) Test Bar
two (2) Fixation Screws
one (1) "S" Hook
two (2) Lock Nuts



R1945

RUGGLES™ Gardner–Wells Traction Tongs Set

Components

	Catalog #
Lock Nuts	R1942
Test Bar	R1946
Fixation Screw	R1947
"S" Hook	R1949



R1947

RUGGLES™ Gardner–Wells Traction Tongs

Titanium

	Length	Catalog #
Maximum Opening	6 1/4" (159mm)	R1944
Spare Screws (pair)		R1944TS



R1945

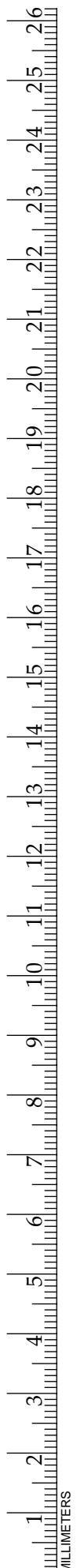

RONGEURS, KERRISONS AND IVDS



RONGEURS, KERRISONS AND IVDS

Bone Cutting Rongeurs

RUGGLES™ Devilbliss Cranial Rongeur

8 1/2"
(216mm)

R1300



R1300

RUGGLES™ Stille–Liston Bone Cutting Rongeur

10 1/2"
(267mm)

Straight R1305

Curved R1306



R1305

RUGGLES™ Stille–Horsley Bone Cutting Rongeur

10 1/2"
(267mm)

Double Curve R1307



R1307

RUGGLES™ Ruskin–Liston Bone Cutting Rongeur

7 1/2"
(191mm)

Straight R1310

Up Angled R1312



R1310



Single Action Bone Rongeurs

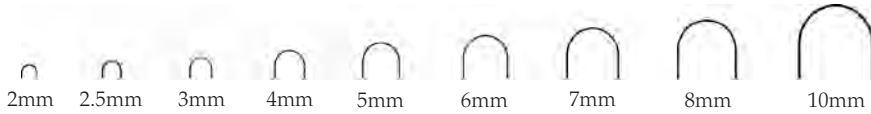

RUGGLES™ Stookey Single Action Bone Rongeur

Bite 7 3/8"
(188mm)

3mm **R1320**

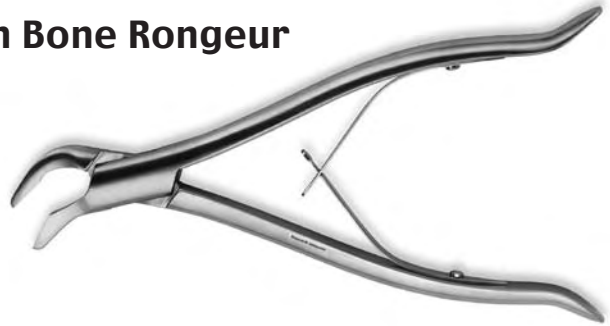

R1320

RUGGLES™ Lempert Single Action Bone Rongeur

Straight

Bite 6 1/4" 7 1/2"
(159mm) (191mm)

2mm **R1324** **R1326**

Curved

Bite 6 1/4" 7 1/2"
(159mm) (191mm)

2mm **R1325** **R1327**

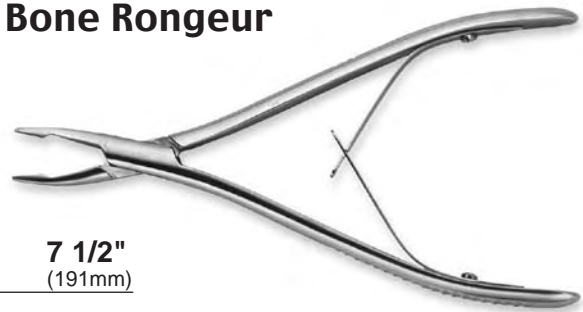

R1325

RUGGLES™ Adson Single Action Bone Rongeur

Bite 8"
(203mm)

8mm **R1330**

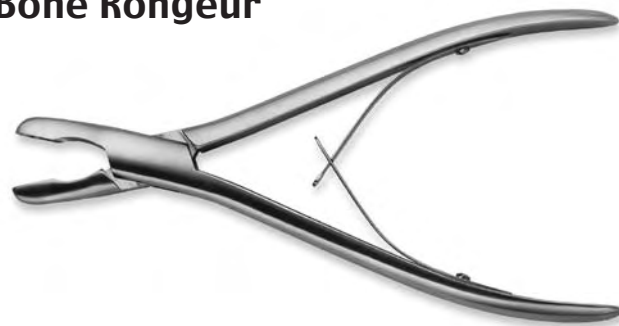

R1330



Double Action Bone Rongeurs

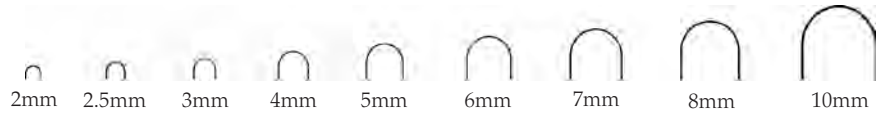

RUGGLES™ Stille Double Action Bone Rongeur

9"
(229mm)

Straight **R1470**

Curved **R1475**

Angular **R1480**

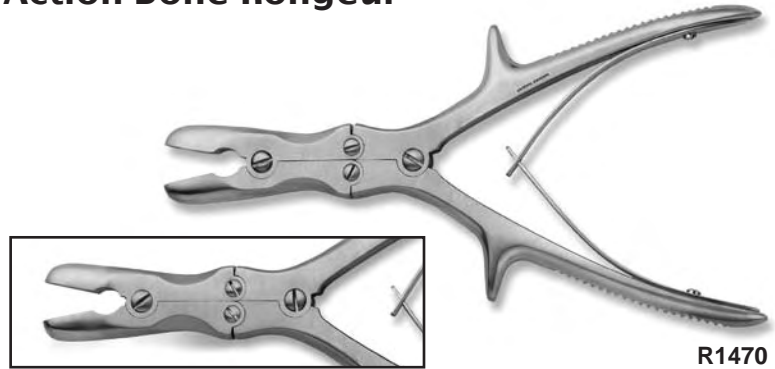

RUGGLES™ Stille-Echlin Double Action Bone Rongeur Flat Lower Jaw

Bite **9"**
(229mm)

6mm **R1385**



Double Action Bone Rongeurs

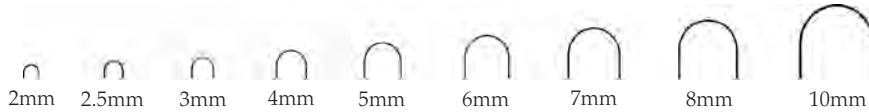

RUGGLES™ Stille-Luer Double Action Bone Rongeur



Straight

Curved

Bite **8 1/2"**
(216mm) **10 1/2"**
(267mm)

Bite **8 1/2"**
(216mm) **10 1/2"**
(267mm)

RN3024

10mm **RN3022** **RN3024**

10mm **RN3023** **RN3025**

RUGGLES™ Stille-Luer Duckbill Double Action Bone Rongeur

Bite **9"**
(229mm)

5mm **RN3026**



RN3026

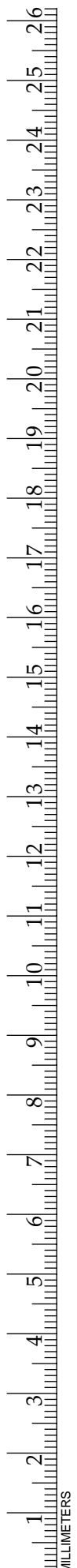

Double Action Bone Rongeurs

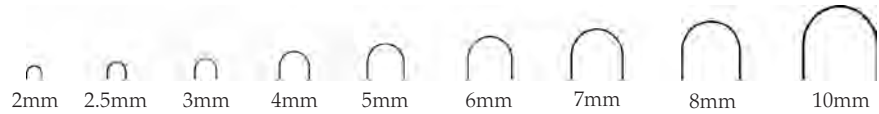

RUGGLES™ Ruskin Double Action Bone Rongeur



Straight

	6" (152mm)	7 1/4" (184mm)
Bite		
2mm	R1338	
5mm		R1340
6mm		R1342

Curved

	6" (152mm)	7 1/4" (184mm)
Bite		
2mm	R1339	
5mm		R1341
6mm		R1343

Duckbill

	6" (152mm)
Bite	
6mm	R1344

R-1338



Double Action Bone Rongeurs

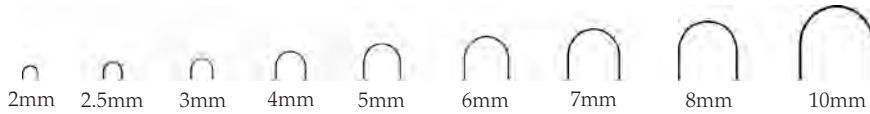

RUGGLES™ Zaufal–Jansen Double Action Bone Rongeur

Curved

Bite 6 3/4"
(171mm)

4mm **R1350**



R1350

RUGGLES™ Beyer Double Action Bone Rongeur

Bite 7"
(178mm)

3mm **R1355**



R1355

RUGGLES™ Echlin Double Action Bone Rongeur

Straight

Bite 9"
(229mm)

2mm **R1370**

3mm **R1375**

4mm **R1380**

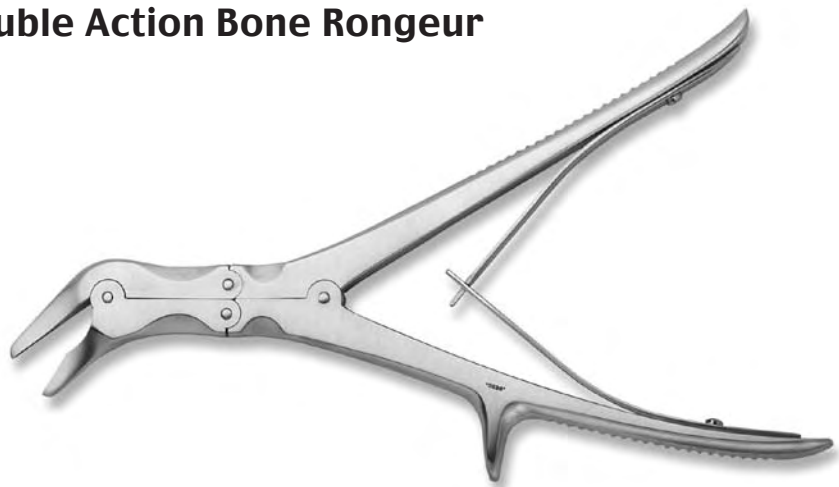

R1370



Double Action Bone Rongeurs

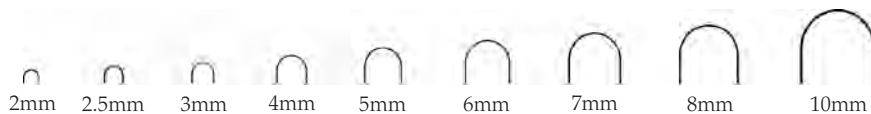

RUGGLES™ Smith-Peterson Double Action Bone Rongeur



R1381

Straight

	Bite	7 1/2" (191mm)	9 1/2" (241mm)
3mm	R1386	R1381	

Slight Curve

	Bite	7 1/2" (191mm)	9 1/2" (241mm)
3mm	R1387	R1382	

Full Curve

	Bite	7 1/2" (191mm)	9 1/2" (241mm)
3mm	R1388	R1383	



Double Action Bone Rongeurs

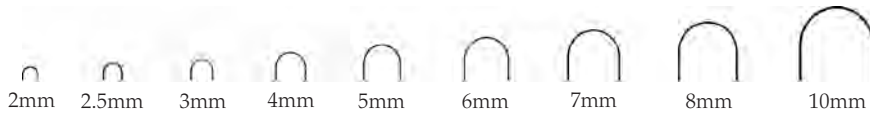

RUGGLES™ Fulton Double Action Bone Rongeur



Straight

Slight Curve

Full Curve

Bite 9 1/2"
(241mm)

Bite 9 1/2"
(241mm)

Bite 9 1/2"
(241mm)

7mm **R1390**

7mm **R1391**

7mm **R1392**

R1390

RUGGLES™ Leksell Double Action Bone Rongeur



R1465

Regular Curve

Strong Curve

Bite 9 3/4"
(248mm)

Bite 9 3/4"
(248mm)

3mm **R1455**

3mm **R1465**

6mm **R1450**

6mm **R1460**

8mm **R1445**

8mm **R1458**

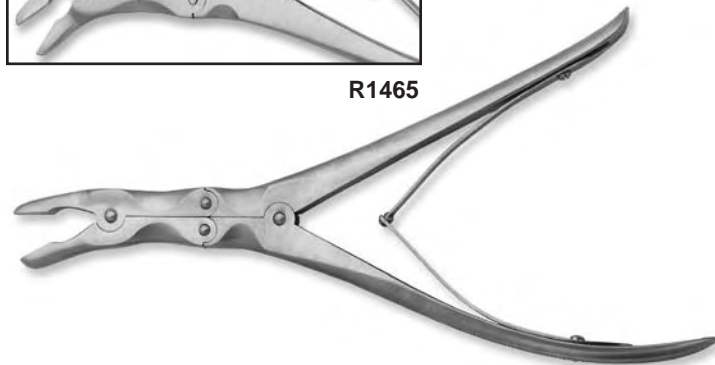

R1445

RUGGLES™ Leksell Double Action Bone Rongeur



RN3035

Regular Curve

Strong Curve

Bite 9"
(229mm)

Bite 9"
(229mm)

3mm **RN3032**

3mm **RN3035**

5mm **RN3031**

5mm **RN3034**

8mm **RN3030**

8mm **RN3033**



RN3030

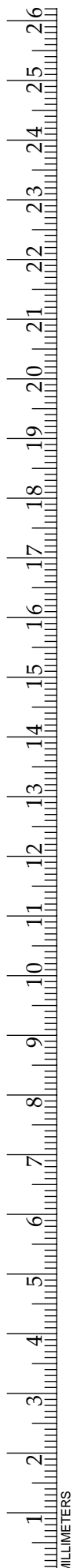

Hercules Wire Cutters

RUGGLES™ Hercules Triple Action Wire Cutter 30° Blades (Cuts 3.0mm wire)

The Hercules Triple Action Wire Cutter will enable cutting of up to 3mm pins with ease. The jaws feature a unique gripping action which eliminated free-fragment release.



R3325 Super Master Wire Cutter
30° Angle Blades, 23cm
Cuts 3.0mm Hard Wire

R3325

R3320 Tungsten Carbide Inserts for R3325

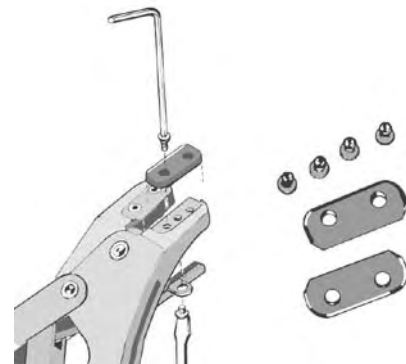

R3320

R3321 Pin Holding Inserts for R3325

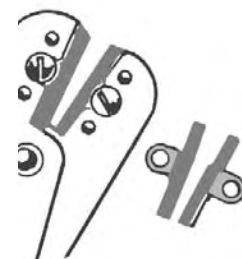

R3321



IVD Rongeurs



RUGGLES™ Cushing Delicate Pattern Intervertebral Disc Rongeur

2mm x 10mm Cup

7"
(178mm)

Straight	RN5712
Straight w/ Teeth	RN5712X
Up	RN5722
Up w/ Teeth	RN5722X
Down	RN5732



RUGGLES™ Cushing Intervertebral Disc Rongeur

1.5 x 10mm Cup

6" (152mm) **7"** (178mm) **9"** (229mm)

Straight	RN5680	RN5780	RN5980
Up	RN5681	RN5781	RN5981
Down	RN5682	RN5782	RN5982



2 x 10mm Cup

5" (127mm) **6"** (152mm) **7"** (178mm) **9"** (229mm) **11"** (279mm) **12"** (305mm)

Straight	RN5512H	RN5612H	RN5712H	RN5912H	RN51112H	RN51212H
Up	RN5522H	RN5622H	RN5722H	RN5922H	RN51122H	RN51222H
Down	RN5532H	RN5632H	RN5732H	RN5932H	RN51132H	RN51232H
Straight w/ Teeth	RR5712X					
Up w/ Teeth	RN5622X		RR5722X			
Down w/ Teeth	RN5732X					

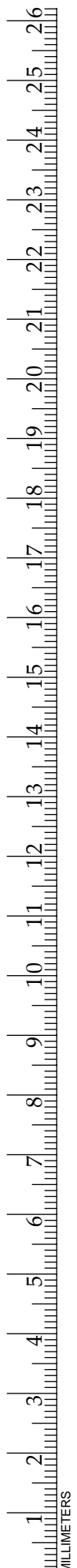

IVD Rongeurs



RUGGLES™

Love-Gruenwald Delicate Pattern Intervertebral Disc Rongeur

3 x 10mm Cup

7"
(178mm)

Straight	RN5743
Straight w/ Teeth	RN5743X
Up	RN5753
Up w/ Teeth	RN5753X
Down	RN5763
Down w/ Teeth	RN5763X



RN5763

RUGGLES™ Love-Gruenwald Intervertebral Disc Rongeur

3 x 10mm Cup

5" (127mm) **6"** (152mm) **7"** (178mm) **9"** (229mm) **11"** (279mm) **12"** (305mm)

Straight	RN5543H	RN5643H	RN5743H	RN5943H	RN51143H	RN51243H
Up	RN5553H	RN5653H	RN5753H	RN5953H	RN51153H	RN51253H
Down	RN5563H	RN5663H	RN5763H	RN5963H	RN51163H	RN51263H
Straight w/Teeth	RN5743HX					
Up w/Teeth	RN5753HX					
Down w/Teeth	RN5763HX					



RN5943H



IVD Rongeurs

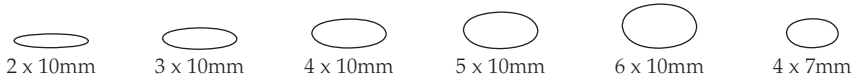

RUGGLES™ Poppen Intervertebral Disc Rongeur

4 x 7mm Cup

	5" (127mm)	7" (178mm)
Straight	R1785	R1765
Up	R1786	R1766
Down	R1787	R1767



RUGGLES™ Intervertebral Disc Rongeur

5 x 10mm Cup

	9" (229mm)	11" (279mm)	12" (305mm)
Straight	R18045	R18165	R18615
Up	R18055	R18175	R18625
Down	R18065	R18185	R18635

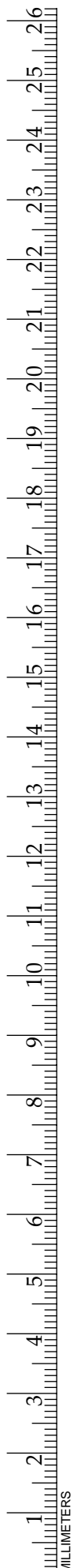

IVD Rongeurs

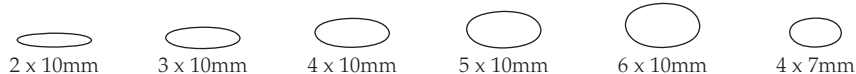

RUGGLES™ Spurling Delicate Pattern Intervertebral Disc Rongeur

4 x 10mm Cup

7"
(178mm)

Straight	RN5744
Straight w/ Teeth	RN5744X
Up	RN5754
Up w/ Teeth	RN5754X
Down	RN5764
Down w/ Teeth	RN5764X

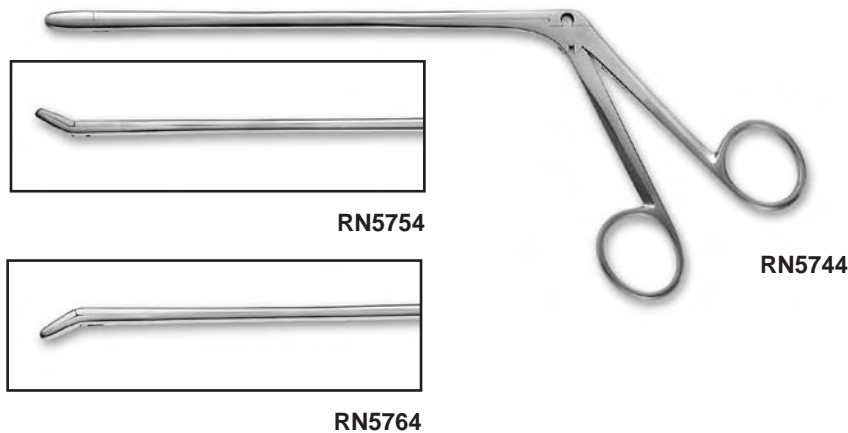

RUGGLES™ Spurling Intervertebral Disc Rongeur

4 x 10mm Cup

5" (127mm) **6"** (152mm) **7"** (178mm) **9"** (229mm) **11"** (279mm) **12"** (305mm)

Straight	RN5544H	RN5644H	RN5744H	RN5944H	RN51144H	RN51244H
Up	RN5554H	RN5654H	RN5754H	RN5954H	RN51154H	RN51254H
Down	RN5564H	RN5664H	RN5764H	RN5964H	RN51164H	RN51264H



IVD Rongeurs

2 x 10mm

3 x 10mm

4 x 10mm

5 x 10mm

6 x 10mm

4 x 7mm

RUGGLES™ Spurling Intervertebral Disc Rongeur

3mm Cup

Angled Tip 7"
(178mm)

Left **R1758**

Right **R1759**



RUGGLES™ Cloward Intervertebral Disc Rongeur Fenestrated with Teeth

6 x 10mm Cup

5"
(127mm)

Straight **R1790**

Up **R1791**

Down **R1792**

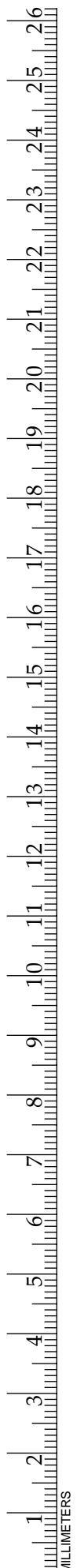

IVD Rongeurs

2.5 x 7mm

3 x 7mm

4 x 7mm

RUGGLES™ Peapod Intervertebral Disc Rongeur

Cup Size	5 1/2" (140mm)	7" (178mm)
Small (2.5mm x 7mm)	RN5526	R1722
Medium (3.0mm x 7mm)	RN5527	R1723
Large (4.0 x 7mm)	RN5528	R1724



RN5526



IVD Rongeurs

RUGGLES™ Wilde Intervertebral Disc Rongeur

Fenestrated, Delicate Pattern

Straight

Cup Size	5 1/2" (140mm)	7" (178mm)	9" (229mm)
3mm x 8mm		RN5703	RN5903
4mm x 9mm	RN5603	RN5704	RN5904
5mm x 11mm	RN5604	RN5705	RN5905
6mm x 13mm	RN5605		



RN5705

RUGGLES™ Wilde Intervertebral Disc Rongeur

Fenestrated

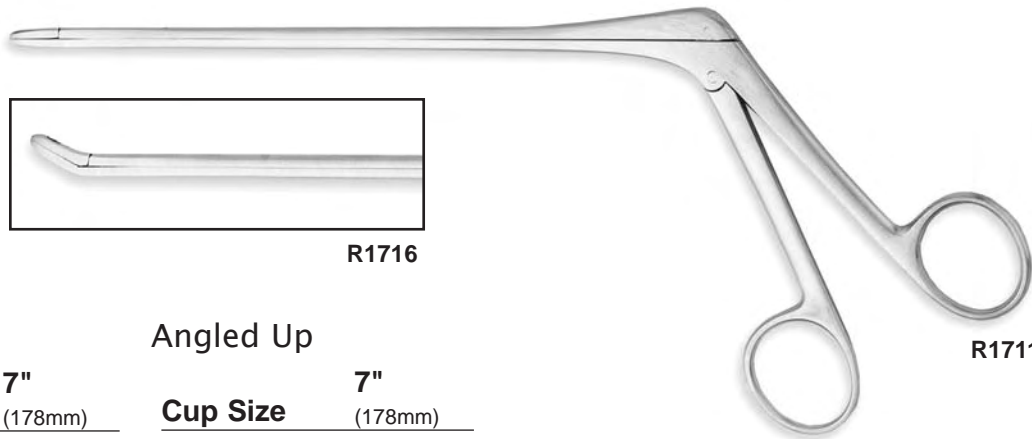

R1716

R1711

Straight

Cup Size	7" (178mm)	Angled Up	7" (178mm)
2.5 x 7mm	R1711	2.5 x 7mm	R1716
3 x 8mm	R1712	3 x 8mm	R1717
4 x 9mm	R1713	4 x 9mm	R1718
5 x 11mm	R1714	5 x 11mm	R1719

Angled Up



IVD Rongeurs

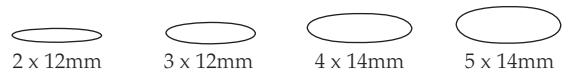

RUGGLES™ Caspar Intervertebral Disc Rongeur

Double Fenestrated with Teeth

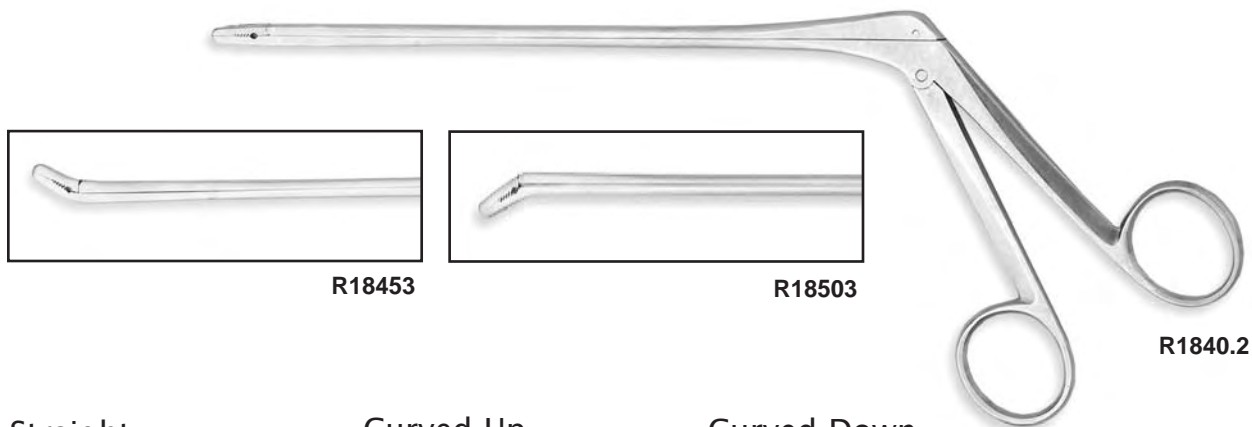

Straight

Cup Size	7 1/4" (184mm)
2 x 12mm	R18402
3 x 12mm	R18403
4 x 14mm	R18404
5 x 14mm	R18405

Curved Up

Cup Size	7 1/4" (184mm)
3 x 12mm	R18453
4 x 14mm	R18454
5 x 14mm	R18455

Curved Down

Cup Size	7 1/4" (184mm)
3mm x 12mm	R18503
4mm x 14mm	R18504



IVD Rongeurs



RUGGLES™ Jackson Intervertebral Disc Rongeur

70° Up

Cup Size 7"
(178mm)

4 x 8mm R1745



RUGGLES™ Micro Disc Rongeur

Straight

Teeth 5 1/2"
(140mm)

1 x 2 RN7132



IVD Rongeurs

1.5 x 5mm 2 x 10mm 3 x 10mm 4 x 8mm 4 x 10mm 5 x 10mm 6 x 10mm 6 x 12mm

RUGGLES™ Ferris-Smith Intervertebral Disc Rongeur



RN5802

Straight

Cup Size	7" (178mm)
2 x 10mm	RN5802
3 x 10mm	RN5803
4 x 8mm	RN5808
4 x 10mm	RN5804
6 x 10mm	RN5806
6 x 12mm	RN5805

Up

Cup Size	7" (178mm)
2 x 10mm	RN5812
3 x 10mm	RN5813
4 x 10mm	RN5814
6 x 10mm	RN5816

Down

Cup Size	7" (178mm)
2 x 10mm	RN5822
3 x 10mm	RN5823
4 x 10mm	RN5824
6 x 10mm	RN5826

RUGGLES™ Decker Intervertebral Disc Rongeur

1.5 x 5mm Cup

Cup Size	6" (152mm)
Right	RN7127
Left	RN7128
Down	RN7129
Up	RN7130
Straight	RN7131



RN7131



Micro Kerrison Rongeurs

RUGGLES™ Micro Kerrison Rongeur Small, Improved Handle

Bite Size in mm



Cutting Angle



40° Up

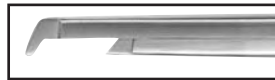

40° Down

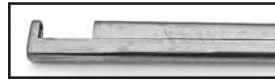

90° Up



90° Down

9mm Jaw Opening

Cutting Angle	Bite Size	7" (178mm)	8" (203mm)	11" (279mm)	12" (305mm)
40° Up	1mm	R1648			
40° Up	2mm	R1611	R1667	R15302	R15502
40° Up	3mm	R1612	R1490	R15303	R15503
40° Up	4mm	R1613	R1491	R15304	R15504
40° Up	5mm	R1614	R1492	R15305	R15505
40° Up	6mm	R1615	R1493	R15306	R15506
40° Down	1mm	R16501			
40° Down	2mm	R16502	R15102		
40° Down	3mm	R16503	R15103	R15353	R15553
40° Down	4mm	R16504	R15104	R15354	R15554
40° Down	5mm	R16505	R15105	R15355	R15555
40° Down	6mm	R16506	R15106	R15356	R15556
90° Up	1mm	R1649			
90° Up	2mm	R1601	R1665		
90° Up	3mm	R1602	R1494	R15403	R15603
90° Up	4mm	R1603	R1495	R15404	R15604
90° Up	5mm	R1604	R1496	R15405	R15605
90° Up	6mm	R1605	R15156	R15406	R15606
90° Down	2mm	R1606	R1666		
90° Down	3mm	R1607	R1497	R15453	R15653
90° Down	4mm	R1608	R1498	R15454	R15654
90° Down	5mm	R1609	R1499	R15455	R15655
90° Down	6mm	R1610	R15206	R15456	R15656

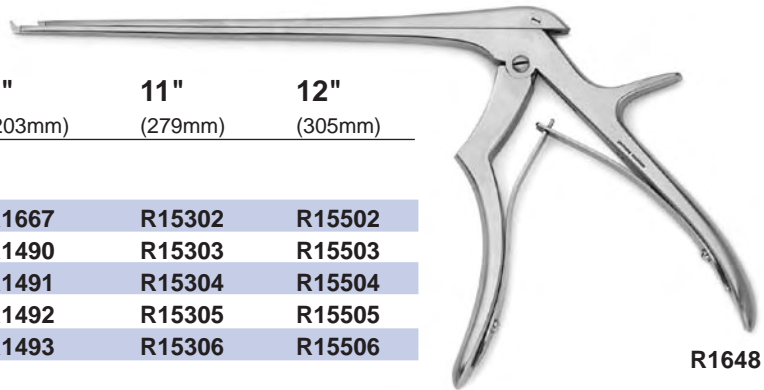

R1648

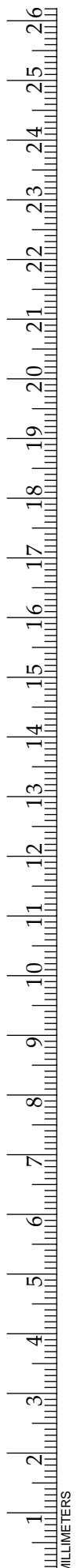

Micro Kerrison Rongeurs

RUGGLES™ Micro Kerrison Rongeur

Small, Improved Handle, Thin Footplate

Bite Size in mm



Cutting Angle



9mm Jaw Opening

Cutting Angle	Bite Size	6" (152mm)	7" (178mm)	8" (203mm)	9" (229mm)	10" (254mm)	11" (279mm)
40° Up	1mm		RN4771	RN4891	RN4991	RN41091	RN41191
40° Up	1.5mm		RN4751	RN4851	RN4951	RN41051	RN41151
40° Up	2mm	RN4652	RN4752	RN4882	RN4952	RN41052	RN41152
40° Up	3mm	RN4653	RN4753	RN4853	RN4953	RN41053	RN41153
40° Up	4mm	RN4654	RN4754	RN4854	RN4954	RN41054	RN41154
40° Up	5mm	RN4655	RN4755	RN4855	RN4955	RN41055	RN41155
40° Up	6mm	RN4656	RN4756	RN4856	RN4956	RN41056	RN41156
40° Down	1mm		RN4790	RN4890			
40° Down	2mm	RN4662	RN4772	RN4892	RN4962	RN41062	RN41162
40° Down	3mm	RN4663	RN4763	RN4863	RN4963	RN41063	RN41163
40° Down	4mm	RN4664	RN4764	RN4864	RN4964	RN41064	RN41164
40° Down	5mm	RN4665	RN4765	RN4865	RN4965	RN41065	RN41165
40° Down	6mm	RN4666	RN4766	RN4866	RN4966	RN41066	RN41166
90° Up	1mm		RN4761	RN4861			
90° Up	2mm	RN4632	RN4732	RN4862	RN4932	RN41032	RN41132
90° Up	3mm	RN4633	RN4733	RN4833	RN4933	RN41033	RN41133
90° Up	4mm	RN4634	RN4734	RN4834	RN4934	RN41034	RN41134
90° Up	5mm	RN4635	RN4735	RN4835	RN4935	RN41035	RN41135
90° Up	6mm	RN4636	RN4736	RN4836	RN4936	RN41036	RN41136
90° Down	1mm		RN4760	RN4860			
90° Down	2mm	RN4642	RN4742	RN4872	RN4972	RN41042	RN41142
90° Down	3mm	RN4643	RN4743	RN4843	RN4943	RN41043	RN41143
90° Down	4mm	RN4644	RN4744	RN4844	RN4944	RN41044	RN41144
90° Down	5mm	RN4645	RN4745	RN4845	RN4945	RN41045	RN41145
90° Down	6mm	RN4646	RN4746	RN4846	RN4946	RN41046	RN41146



Micro Kerrison Rongeurs

RUGGLES™ Stealth Micro Kerrison Rongeur

Small, Improved Handle, Thin Footplate

Bite Size in mm



Cutting Angle

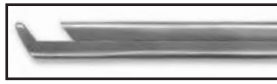

40° Up



40° Down



90° Up



90° Down



RB4655

The “Stealth” surface is a propriety surface treatment intended to reduce the friction between metal surfaces, which makes the kerrison’s gliding action smoother and last longer. The dark surface also decreases the glare from the operating room lights.

9mm Jaw Opening

Cutting Angle	Bite Size	6" (152mm)	7" (178mm)	8" (203mm)	9" (229mm)	10" (254mm)	11" (279mm)
40° Up	1mm		RB4771	RB4891	RB4991	RB41091	RB41191
40° Up	1.5mm		RB4751	RB4851	RB4951	RB41051	RB41151
40° Up	2mm	RB4652	RB4752	RB4882	RB4952	RB41052	RB41152
40° Up	3mm	RB4653	RB4753	RB4853	RB4953	RB41053	RB41153
40° Up	4mm	RB4654	RB4754	RB4854	RB4954	RB41054	RB41154
40° Up	5mm	RB4655	RB4755	RB4855	RB4955	RB41055	RB41155
40° Up	6mm	RB4656	RB4756	RB4856	RB4956	RB41056	RB41156
40° Down	1mm		RB4790	RB4890			
40° Down	2mm	RB4662	RB4772	RB4892	RB4962	RB41062	RB41162
40° Down	3mm	RB4663	RB4763	RB4863	RB4963	RB41063	RB41163
40° Down	4mm	RB4664	RB4764	RB4864	RB4964	RB41064	RB41164
40° Down	5mm	RB4665	RB4765	RB4865	RB4965	RB41065	RB41165
40° Down	6mm	RB4666	RB4766	RB4866	RB4966	RB41066	RB41166
90° Up	1mm		RB4761	RB4861			
90° Up	2mm	RB4632	RB4732	RB4862	RB4932	RB41032	RB41132
90° Up	3mm	RB4633	RB4733	RB4833	RB4933	RB41033	RB41133
90° Up	4mm	RB4634	RB4734	RB4834	RB4934	RB41034	RB41134
90° Up	5mm	RB4635	RB4735	RB4835	RB4935	RB41035	RB41135
90° Up	6mm	RB4636	RB4736	RB4836	RB4936	RB41036	RB41136
90° Down	1mm		RB4760	RB4860			
90° Down	2mm	RB4642	RB4742	RB4872	RB4942	RB41042	RB41142
90° Down	3mm	RB4643	RB4743	RB4843	RB4943	RB41043	RB41143
90° Down	4mm	RB4644	RB4744	RB4844	RB4944	RB41044	RB41144
90° Down	5mm	RB4645	RB4745	RB4845	RB4945	RB41045	RB41145
90° Down	6mm	RB4646	RB4746	RB4846	RB4946	RB41046	RB41146

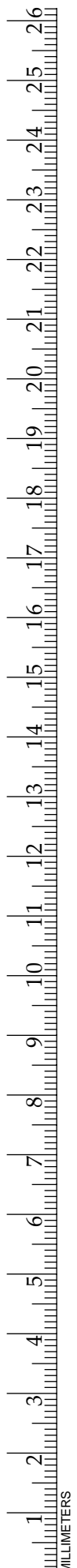

Micro Kerrison Rongeurs

RUGGLES™ Diamond Micro Kerrison Rongeur

Small, Improved Handle, Thin Footplate



"Diamond" is a specific ceramic coating that was developed to make the surface harder, therefore prolonging the life of the cutting edge of the kerrison. It also reduces the glare from the operating room lights while providing durability and smoother gliding action.



9mm Jaw Opening

Cutting Angle	Bite Size	7" (178mm)	8" (203mm)
40° Up	1mm	RD4771	RD4891
40° Up	1.5mm	RD4751	RD4851
40° Up	2mm	RD4752	RD4882
40° Up	3mm	RD4753	RD4853
40° Up	4mm	RD4754	RD4854
40° Up	5mm	RD4755	RD4855
40° Up	6mm	RD4756	RD4856



Medium Kerrison Rongeurs

RUGGLES™ Medium Kerrison Rongeur

Small, Improved Handle, Thin Footplate

Cutting Angle



40° Up

Bite Size in mm



14mm Jaw Opening

Cutting Angle	Bite Size	7" (178mm)	8" (203mm)
40° Up	1mm	RN4721M	RN4821M
40° Up	1.5mm	RN4751M	RN4851M
40° Up	2mm	RN4722M	RN4822M
40° Up	3mm	RN4723M	RN4823M
40° Up	4mm	RN4724M	RN4824M
40° Up	5mm	RN4725M	RN4825M
40° Up	6mm	RN4726M	RN4826M

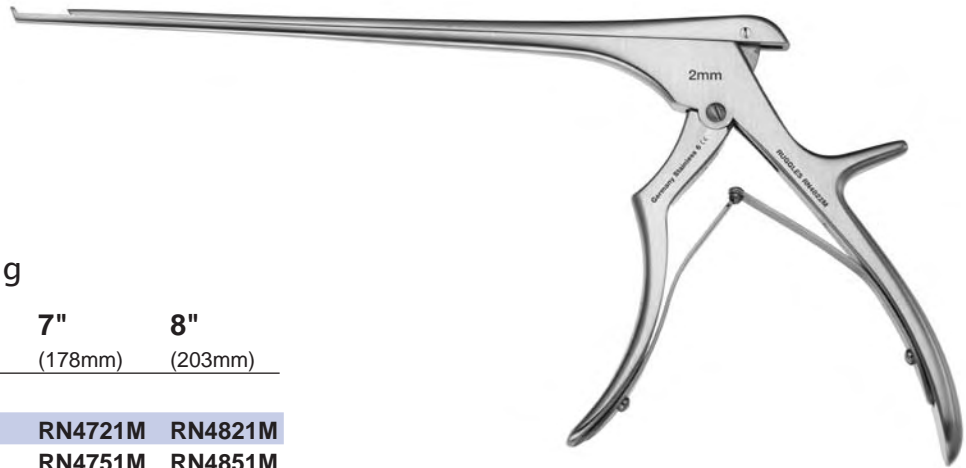

RN4822N



Medium Kerrison Rongeurs

RUGGLES™ Stealth Medium Kerrison Rongeur

Small, Improved Handle, Thin Footplate

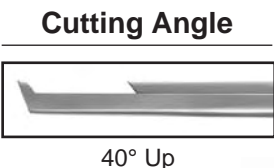

The “Stealth” surface is a propriety surface treatment intended to reduce the friction between metal surfaces, which makes the kerrison’s gliding action smoother and last longer. The dark surface also decreases the glare from the operating room lights.

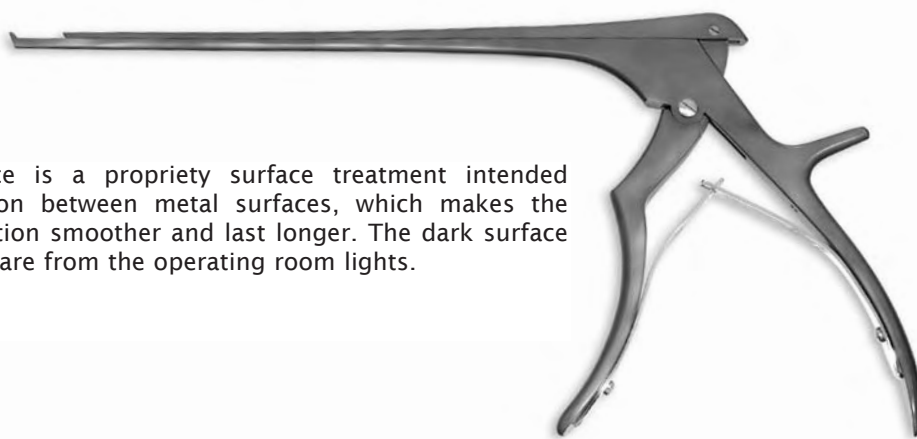

RB4822M

14mm Jaw Opening

Cutting Angle	Bite Size	7" (178mm)	8" (203mm)
40° Up	1mm	RB4721M	RB4821M
40° Up	1.5mm	RB4751M	RB4851M
40° Up	2mm	RB4722M	RB4822M
40° Up	3mm	RB4723M	RB4823M
40° Up	4mm	RB4724M	RB4824M
40° Up	5mm	RB4725M	RB4825M
40° Up	6mm	RB4726M	RB4826M



Medium Kerrison Rongeurs

RUGGLES™ Diamond Medium Kerrison Rongeur Small, Improved Handle, Thin Footplate

Cutting Angle



40° Up

Bite Size in mm

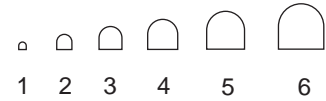

"Diamond" is a specific ceramic coating that was developed to make the surface harder, therefore prolonging the life of the cutting edge of the kerrison. It also reduces the glare from the operating room lights while providing durability and smoother gliding action.

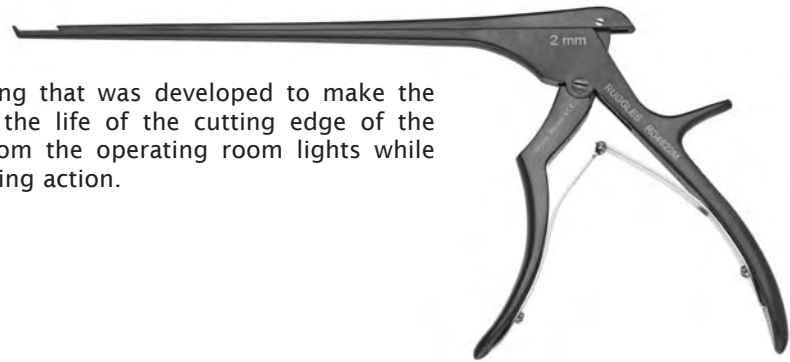

RD4822M

14mm Jaw Opening

Cutting Angle	Bite Size	8" (203mm)
40° Up	1mm	RD4821M
40° Up	1.5mm	RD4851M
40° Up	2mm	RD4822M
40° Up	3mm	RD4823M
40° Up	4mm	RD4824M
40° Up	5mm	RD4825M
40° Up	6mm	RD4826M

Spurling Kerrison Rongeurs

RUGGLES™ Spurling Kerrison Rongeur Large, Improved Handle

Bite Size in mm

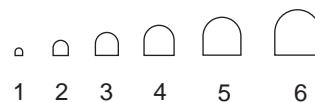

Cutting Angle



40° Up



40° Down



90° Up



90° Down



R15956

15mm Jaw Opening

Cutting Angle	Bite Size	7" (178mm)	8" (203mm)	11" (279mm)	12" (305mm)
40° Up	2mm	R15952	R16102	R16252	R16752
40° Up	3mm	R15953	R1671	R16253	R16753
40° Up	4mm	R15954	R1672	R16254	R16754
40° Up	5mm	R15955	R1673	R16255	R16755
40° Up	6mm	R15956	R1674		
40° Down	2mm			R16552	
40° Down	3mm			R16553	
40° Down	4mm			R16554	
40° Down	5mm			R16555	
90° Up	2mm	R16052		R16602	
90° Up	3mm	R16053	R1651	R16603	
90° Up	4mm	R16054	R1652	R16604	
90° Up	5mm	R16055	R1653	R16605	
90° Up	6mm		R1654		
90° Down	2mm			R16652	R16802
90° Down	3mm		R1661	R16653	R16803
90° Down	4mm		R1662	R16654	R16804
90° Down	5mm		R1663	R16655	R16805
90° Down	6mm		R1664		



Spurling Kerrison Rongeurs

RUGGLES™ Spurling Kerrison Rongeur Large, Improved Handle, Thin Footplate

Bite Size in mm



Cutting Angle



40° Up



90° Up



90° Down



RN4622

15mm Jaw Opening

Cutting Angle	Bite Size	6" (152mm)	7" (178mm)	8" (203mm)	9" (229mm)	10" (254mm)	11" (279mm)
40° Up	2mm	RN4622	RN4722	RN4822	RN4922	RN41022	RN41122
40° Up	3mm	RN4623	RN4723	RN4823	RN4923	RN41023	RN41123
40° Up	4mm	RN4624	RN4724	RN4824	RN4924	RN41024	RN41124
40° Up	5mm	RN4625	RN4725	RN4825	RN4925	RN41025	RN41125
40° Up	6mm	RN4626	RN4726	RN4826	RN4926	RN41026	RN41126
90° Up	2mm	RN4602	RN4702	RN4802	RN4902	RN41002	RN41102
90° Up	3mm	RN4603	RN4703	RN4803	RN4903	RN41003	RN41103
90° Up	4mm	RN4604	RN4704	RN4804	RN4904	RN41004	RN41104
90° Up	5mm	RN4605	RN4705	RN4805	RN4905	RN41005	RN41105
90° Up	6mm	RN4606	RN4706	RN4806	RN4906	RN41006	RN41106
90° Down	2mm	RN4612	RN4712	RN4812	RN4912	RN41012	RN41112
90° Down	3mm	RN4613	RN4713	RN4813	RN4913	RN41013	RN41113
90° Down	4mm	RN4614	RN4714	RN4814	RN4914	RN41014	RN41114
90° Down	5mm	RN4615	RN4715	RN4815	RN4915	RN41015	RN41115
90° Down	6mm	RN4616	RN4716	RN4816	RN4916	RN41016	RN41116

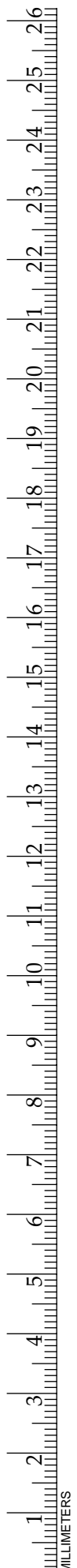

Spurling Kerrison Rongeurs

RUGGLES™ Stealth Spurling Kerrison Rongeur

Large, Improved Handle, Thin Footplate

Bite Size in mm

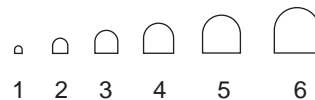

Cutting Angle



40° Up



90° Up



90° Down



The “Stealth” surface is a propriety surface treatment intended to reduce the friction between metal surfaces, which makes the kerrison’s gliding action smoother and last longer. The dark surface also decreases the glare from the operating room lights.

15mm Jaw Opening

RB4823

Cutting Angle	Bite Size	6" (152mm)	7" (178mm)	8" (203mm)	9" (229mm)	10" (254mm)	11" (279mm)
40° Up	2mm	RB4622	RB4722	RB4822	RB4922	RB41022	RB41122
40° Up	3mm	RB4623	RB4723	RB4823	RB4923	RB41023	RB41123
40° Up	4mm	RB4624	RB4724	RB4824	RB4924	RB41024	RB41124
40° Up	5mm	RB4625	RB4725	RB4825	RB4925	RB41025	RB41125
40° Up	6mm	RB4626	RB4726	RB4826	RB4926	RB41026	RB41126
90° Up	2mm	RB4602	RB4702	RB4802	RB4902	RB41002	RB41102
90° Up	3mm	RB4603	RB4703	RB4803	RB4903	RB41003	RB41103
90° Up	4mm	RB4604	RB4704	RB4804	RB4904	RB41004	RB41104
90° Up	5mm	RB4605	RB4705	RB4805	RB4905	RB41005	RB41105
90° Up	6mm	RB4606	RB4706	RB4806	RB4906	RB41006	RB41106
90° Down	2mm	RB4612	RB4712	RB4812	RB4912	RB41012	RB41112
90° Down	3mm	RB4613	RB4713	RB4813	RB4913	RB41013	RB41113
90° Down	4mm	RB4614	RB4714	RB4814	RB4914	RB41014	RB41114
90° Down	5mm	RB4615	RB4715	RB4815	RB4915	RB41015	RB41115
90° Down	6mm	RB4616	RB4716	RB4816	RB4916	RB41016	RB41116



Spurling Kerrison Rongeurs

RUGGLES™ Diamond Spurling Kerrison Rongeur Large, Improved Handle, Thin Footplate

Cutting Angle



40° Up

Bite Size in mm

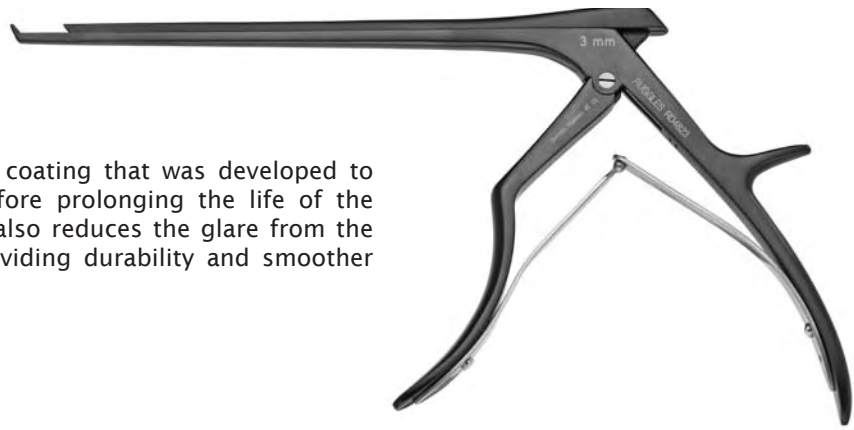

RD4823

"Diamond" is a specific ceramic coating that was developed to make the surface harder, therefore prolonging the life of the cutting edge of the kerrison. It also reduces the glare from the operating room lights while providing durability and smoother gliding action.

15mm Jaw Opening

Cutting Angle	Bite Size	7" (178mm)	8" (203mm)
40° Up	2mm	RD4722	RD4822
40° Up	3mm	RD4723	RD4823
40° Up	4mm	RD4724	RD4824
40° Up	5mm	RD4725	RD4825
40° Up	6mm	RD4726	RD4826

Spurling Kerrisons Rongeurs with Cherry Handle

RUGGLES™ Spurling Kerrison Rongeur Cherry Handle

Cutting Angle

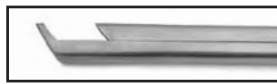

40° Up



90° Up

Bite Size in mm



15mm Jaw Opening

Cutting Angle	Bite Size	7" (178mm)	8" (203mm)	11" (279mm)
40° Up	2mm	R1545		
40° Up	3mm	R1546	R1571	R1576
40° Up	4mm	R1547	R1572	R1577
40° Up	5mm	R1548	R1573	R1578
40° Up	6mm	R1549	R1574	R1579
90° Up	3mm		R1551	
90° Up	4mm		R1552	
90° Up	5mm		R1553	
90° Up	6mm		R1554	

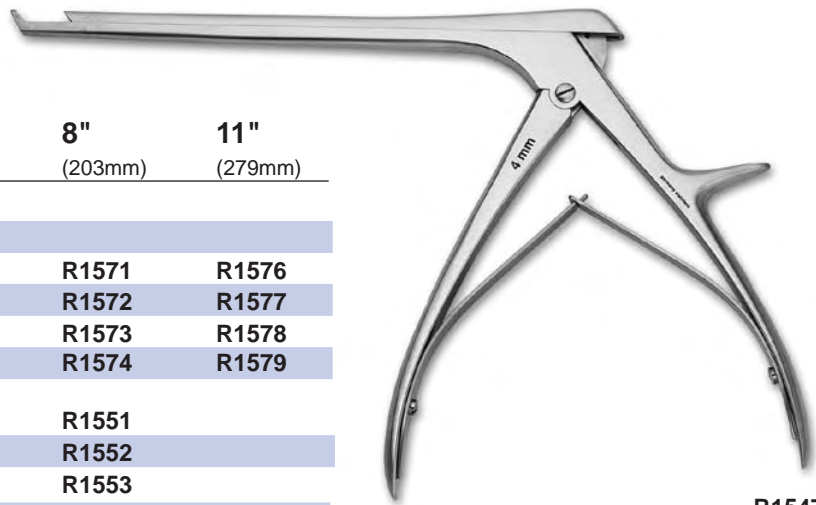

R1547

RUGGLES™ Tew Spurling Kerrison Rongeur Cherry Handle

Cutting Angle



40° Up

15mm Jaw Opening

Cutting Angle	Bite Size	9" (229mm)
40° Up	2mm	R1575



R1575



Spurling Kerrison Rongeurs with Cherry Handle

RUGGLES™ Spurling Kerrison Rongeur Cherry Handle, Thin Footplate

Bite Size in mm



Cutting Angle



40° Up



90° Up



90° Down



15mm Jaw Opening

RN4723X

Cutting Angle	Bite Size	6" (152mm)	7" (178mm)	8" (203mm)	9" (229mm)
40° Up	2mm	RN4622X	RN4722X	RN4822X	RN4922X
40° Up	3mm	RN4623X	RN4723X	RN4823X	
40° Up	4mm	RN4624X	RN4724X	RN4824X	
40° Up	5mm	RN4625X	RN4725X	RN4825X	
40° Up	6mm	RN4626X	RN4726X	RN4826X	
90° Up	3mm	RN4603X	RN4703X	RN4803X	
90° Up	4mm	RN4604X	RN4704X	RN4804X	
90° Up	5mm	RN4605X	RN4705X	RN4805X	
90° Up	6mm	RN4606X	RN4706X	RN4806X	
90° Down	3mm	RN4613X	RN4713X	RN4813X	
90° Down	4mm	RN4614X	RN4714X	RN4814X	
90° Down	5mm	RN4615X	RN4715X	RN4815X	
90° Down	6mm	RN4616X	RN4716X	RN4816X	



Spurling Kerrison Rongeurs with Cherry Handle

RUGGLES™ Stealth Spurling Kerrison Rongeur Cherry Handle, Thin Footplate

Bite Size in mm

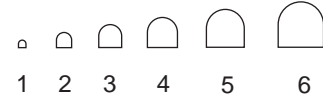

Cutting Angle



40° Up



90° Up



90° Down

The “Stealth” surface is a propriety surface treatment intended to reduce the friction between metal surfaces, which makes the kerrison’s gliding action smoother and last longer. The dark surface also decreases the glare from the operating room lights.

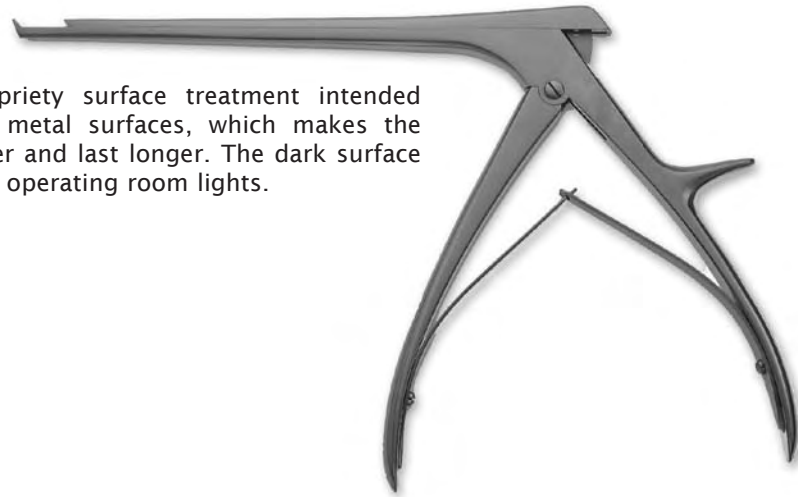

RB4723X

15mm Jaw Opening

Cutting Angle	Bite Size	6" (152mm)	7" (178mm)	8" (203mm)	9" (229mm)
40° Up	2mm	RB4622X	RB4722X	RB4822X	RB4922X
40° Up	3mm	RB4623X	RB4723X	RB4823X	
40° Up	4mm	RB4624X	RB4724X	RB4824X	
40° Up	5mm	RB4625X	RB4725X	RB4825X	
40° Up	6mm	RB4626X	RB4726X	RB4826X	
90° Up	3mm	RB4603X	RB4703X		
90° Up	4mm	RB4604X	RB4704X		
90° Up	5mm	RB4605X	RB4705X		
90° Up	6mm	RB4606X	RB4706X		
90° Down	3mm	RB4613X	RB4713X	RB4813X	
90° Down	4mm	RB4614X	RB4714X	RB4814X	
90° Down	5mm	RB4615X	RB4715X	RB4815X	
90° Down	6mm	RB4616X	RB4716X	RB4816X	

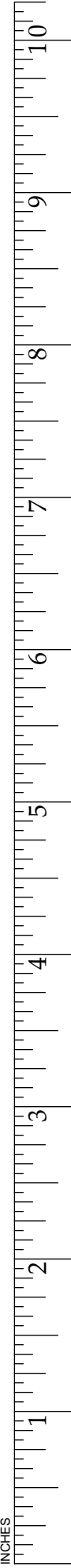

Ferris-Smith Kerrison Rongeurs

RUGGLES™ Ferris-Smith Kerrison Rongeur

Bite Size in mm



Cutting Angle



40° Up



90° Up



90° Down

9mm Jaw Opening

Cutting Angle	Bite Size	7" (178mm)
40° Up	2mm	R1586
40° Up	3mm	R1590
40° Up	4mm	R1592
40° Up	5mm	R1595
90° Up	5mm	R1580
90° Down	5mm	R1582



R1586

RUGGLES™ Open-Handled Kerrison Rongeur

Bite Size in mm

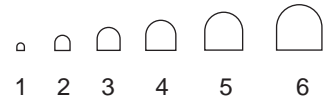

Cutting Angle



40° Up

9mm Jaw Opening

Cutting Angle	Bite Size	7" (178mm)
40° Up	2mm	R1587
40° Up	3mm	R1591
40° Up	4mm	R1593
40° Up	5mm	R1596



R1593

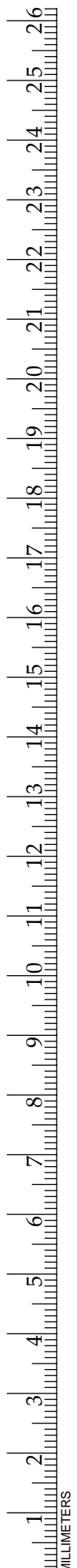

Ferris-Smith Kerrison Rongeurs

RUGGLES™ Ferris-Smith Kerrison Rongeur Thin Footplate

Bite Size in mm



Cutting Angle



40° Up

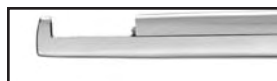

90° Up



90° Down

15mm Jaw Opening

Cutting Angle	Bite Size	7" (178mm)	8" (203mm)
40° Up	2mm	RN4737	
40° Up	3mm	RN4719	RN4819
40° Up	4mm	RN4739	
40° Up	5mm	RN4720	
90° Up	5mm	RN4717	
90° Down	5mm	RN4718	



RN4720



Ferris-Smith Kerrison Rongeurs

RUGGLES™ Stealth Ferris-Smith Kerrison Rongeur Thin Footplate

Bite Size in mm



Cutting Angle



40° Up



90° Up



90° Down



RB4720

The “Stealth” surface is a propriety surface treatment intended to reduce the friction between metal surfaces, which makes the kerrison’s gliding action smoother and last longer. The dark surface also decreases the glare from the operating room lights.

15mm Jaw Opening

Cutting Angle	Bite Size	7" (178mm)
40° Up	3mm	RB4719
40° Up	5mm	RB4720
90° Up	5mm	RB4717
90° Down	5mm	RB4718

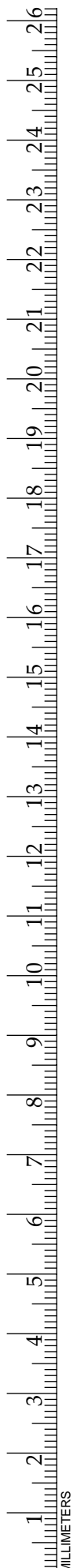

Ejector Kerrison Rongeurs

RUGGLES™ Micro Ejector Kerrison Rongeur

Bar Ejector

Bite Size in mm



Cutting Angle



40° Up

9mm Jaw Opening

Cutting Angle	Bite Size	8" (203mm)
---------------	-----------	------------

40° Up	2mm	R1635
40° Up	3mm	R1636
40° Up	4mm	R1637
40° Up	5mm	R1638



R1636

RUGGLES™ Spurling Ejector Kerrison Rongeur

Bar Ejector

Bite Size in mm



Cutting Angle



40° Up

15mm Jaw Opening

Cutting Angle	Bite Size	8" (203mm)
---------------	-----------	------------

40° Up	3mm	R16403
40° Up	4mm	R16404
40° Up	5mm	R16405



R1640.4



Ejector Kerrison Rongeurs

RUGGLES™ Micro Ejector Kerrison Rongeur

Small, Improved Handle, Thin Footplate, Pin Ejector

Bite Size in mm



Cutting Angle



40° Up



RN4893

9mm Jaw Opening

Cutting Angle	Bite Size	8" (203mm)
---------------	-----------	------------

40° Up	2mm	RN4892E
40° Up	3mm	RN4893
40° Up	4mm	RN4894
40° Up	5mm	RN4895
40° Up	6mm	RN4896

RUGGLES™ Stealth Micro Ejector Kerrison Rongeur

Small, Improved Handle, Thin Footplate, Pin Ejector

Bite Size in mm

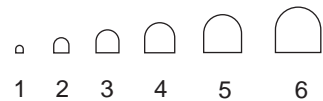

Cutting Angle

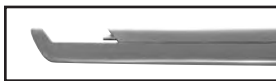

40° Up

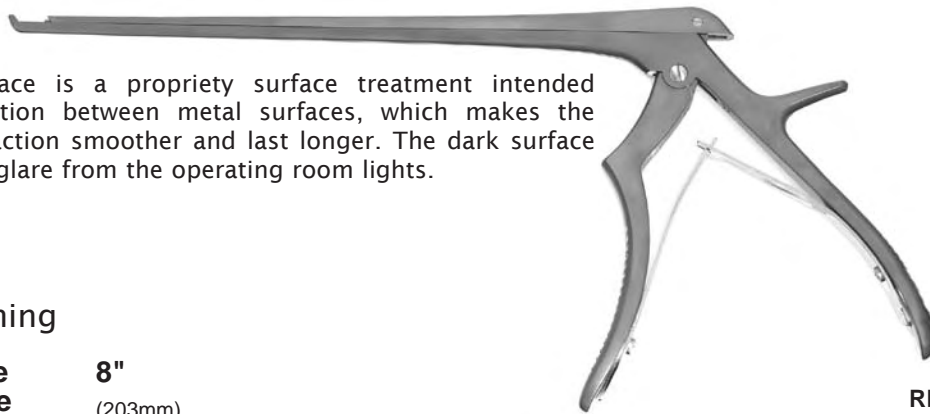

RB4892E

The "Stealth" surface is a propriety surface treatment intended to reduce the friction between metal surfaces, which makes the kerrison's gliding action smoother and last longer. The dark surface also decreases the glare from the operating room lights.

9mm Jaw Opening

Cutting Angle	Bite Size	8" (203mm)
---------------	-----------	------------

40° Up	2mm	RB4892E
40° Up	3mm	RB4893
40° Up	4mm	RB4894
40° Up	5mm	RB4895
40° Up	6mm	RB4896

Curved Kerrison Rongeurs

RUGGLES™ Micro Curved Kerrison Rongeurs

Hinged

Bite Size in mm



Cutting Angle



Curved Up



Curved Left



Curved Right

9mm Jaw Opening

Cutting Angle	Bite Size	8" (203mm)
Curved Up	2mm	R16702
Curved Up	3mm	R16703
Curved Up	4mm	R16704
Curved Up	5mm	R16705
Curved Up	6mm	R16706
Curved Left	3mm	R16703L
Curved Right	3mm	R16703R



R1670.3



Hingeless Curved Kerrison Rongeurs

RUGGLES™ Hingeless Curved Kerrison Rongeur

Bite Size in mm



Cutting Angle



Curved Up

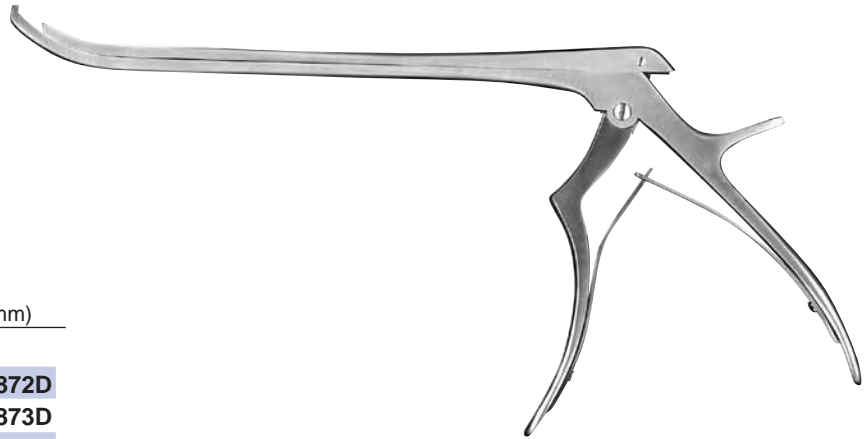

RN4872D

Cutting Angle	Bite Size	8" (203mm)
Curved Up	2mm	RN4872D
Curved Up	3mm	RN4873D
Curved Up	4mm	RN4874D
Curved Up	5mm	RN4875D

RUGGLES™ Stealth Hingeless Curved Kerrison Rongeur

Bite Size in mm



Cutting Angle



Curved Up

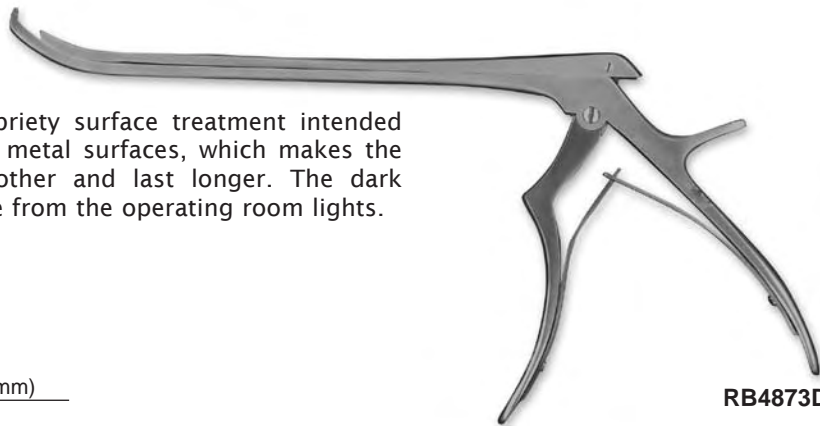

RB4873D

The "Stealth" surface is a propriety surface treatment intended to reduce the friction between metal surfaces, which makes the kerrison's gliding action smoother and last longer. The dark surface also decreases the glare from the operating room lights.

Cutting Angle	Bite Size	8" (203mm)
Curved Up	2mm	RB4872D
Curved Up	3mm	RB4873D
Curved Up	4mm	RB4874D
Curved Up	5mm	RB4875D

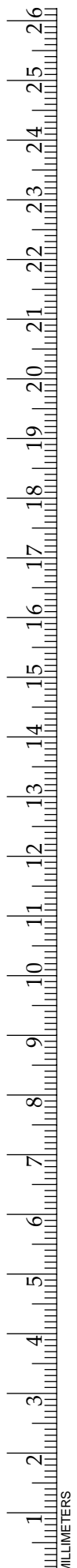

CURETTES



CURETTES

Spinal Fusion Curettes - Standard Back

Curette Cup Size (mm), 6-0 thru #6

Size:	6-0	5-0	4-0	3-0	2-0	1-0	#1	#2	#3	#4	#5	#6
W x L:	1.5 x 2.5	2.0 x 3.0	2.3 x 3.5	2.8 x 3.9	3.0 x 4.6	3.3 x 5.0	4.1 x 6.9	5.0 x 7.5	5.5 x 8.4	7.5 x 10.9	8.8 x 12.5	9.9 x 14.5
	0	0	0	0	0	0	0	0	0	0	0	0

RUGGLES™ Spinal Fusion Curettes

Standard Cup, Hollow Handles

Straight



RN0601

Cup Size	6 3/4" (171mm)	8" (203mm)	9" (229mm)	12" (305mm)
----------	-------------------	---------------	---------------	----------------

5-0	RN06001	RE0800	RN0900	RN01200
4-0	RN0600	RE0801	RN0901	RN01201
3-0	RN0601	RE0802	RN0902	RN01202
2-0	RN0602	RE0803	RN0903	RN01203
1-0	RN0603	RE0804	RN0904	RN01204
#1	RN0604	RE0805	RN0905	RN01205
#2	RN0605	RE0806	RN0906	RN01206
#3	RN0606	RE0807	RN0907	RN01207
#4	RN0607	RE0808	RN0908	RN01208
#5	RN0608	RE0809	RN0909	RN01209
#6	RN0609	RE0810	RN0910	RN01210

RE0800T 8" Set with Instrument Tray

RN0900TS 9" Set with Instrument Tray



Spinal Fusion Curettes - Standard Back

Curette Cup Size (mm), 6-0 thru #6

Size:	6-0	5-0	4-0	3-0	2-0	1-0	#1	#2	#3	#4	#5	#6
W x L:	1.5 x 2.5	2.0 x 3.0	2.3 x 3.5	2.8 x 3.9	3.0 x 4.6	3.3 x 5.0	4.1 x 6.9	5.0 x 7.5	5.5 x 8.4	7.5 x 10.9	8.8 x 12.5	9.9 x 14.5
	0	0	0	0	0	0	0	0	0	0	0	0

RUGGLES™ Spinal Fusion Curettes

Standard Cup, Hollow Handles



RN0923

Angled

Cup Size	6 3/4" (171mm)	8" (203mm)	9" (229mm)	12" (305mm)
----------	-------------------	---------------	---------------	----------------

5-0		RE0820	RN0920	RN01220
4-0		RE0821	RN0921	RN01221
3-0	R0360B	RE0822	RN0922	RN01222
2-0	R0361B	RE0823	RN0923	RN01223
1-0	R0362B	RE0824	RN0924	RN01224
#1	R0363B	RE0825	RN0925	RN01225
#2	R0364B	RE0826	RN0926	RN01226
#3	R0365B	RE0827	RN0927	RN01227
#4	R0366B	RE0828	RN0928	RN01228
#5	R0367B	RE0829	RN0929	RN01229
#6	R0368B	RE0830	RN0930	RN01230

RE0820T 8" Set with Instrument Tray
RN0920TS 9" Set with Instrument Tray

RUGGLES™ Spinal Fusion Curette Tray

R8113	Single Level Holds 10- 9" Curettes
R8114	Double Level Holds 20- 9" Curettes
RS0900	Single Level Holds 12- 8" or 9" Curettes



Spinal Fusion Curettes - Standard Back

Curette Cup Size (mm), 6-0 thru #6

Size:	6-0	5-0	4-0	3-0	2-0	1-0	#1	#2	#3	#4	#5	#6
W x L:	1.5 x 2.5	2.0 x 3.0	2.3 x 3.5	2.8 x 3.9	3.0 x 4.6	3.3 x 5.0	4.1 x 6.9	5.0 x 7.5	5.5 x 8.4	7.5 x 10.9	8.8 x 12.5	9.9 x 14.5
	0	0	0	0	0	0	0	0	0	0	0	0

RUGGLES™ Spinal Fusion Curettes

Standard Cup, Hollow Handles



Reverse Angled

RN0954

Cup Size	8" (203mm)	9" (229mm)	12" (305mm)
5-0	RE0848	RN0948	RN01248
4-0	RE0849	RN0949	RN01249
3-0	RE0850	RN0950	RN01250
2-0	RE0851	RN0951	RN01251
1-0	RE0852	RN0952	RN01252

Cup Size	8" (203mm)	9" (229mm)	12" (305mm)
#1	RE0853	RN0953	RN01253
#2	RE0854	RN0954	RN01254
#3	RE0855	RN0955	RN01255
#4	RE0856	RN0956	RN01256
#5	RE0857	RN0957	RN01257
#6	RE0858	RN0958	RN01258

RE0848T 8" Set with Instrument Tray
RN0948TS 9" Set with Instrument Tray



Spinal Fusion Curettes - Flatback

Curette Cup Size (mm), 6-0 thru #6

Size:	6-0	5-0	4-0	3-0	2-0	1-0	#1	#2	#3	#4	#5	#6
W x L:	1.5 x 2.5	2.0 x 3.0	2.3 x 3.5	2.8 x 3.9	3.0 x 4.6	3.3 x 5.0	4.1 x 6.9	5.0 x 7.5	5.5 x 8.4	7.5 x 10.9	8.8 x 12.5	9.9 x 14.5
	0	0	0	0	0	0	0	0	0	0	0	0

The design of the RUGGLES™ Flatback Curettes has eliminated the bulk at the back of the curette thus allowing the curette to become more maneuverable and efficient in the removing of the disc material.

RUGGLES™ Flatback Spinal Fusion Curettes

Standard Cup, Hollow Handles



R2805

Straight

Cup Size	9" (229mm)	Cup Size	9" (229mm)
6-0	R2799	#1	R2805
5-0	R2800	#2	R2806
4-0	R2801	#3	R2807
3-0	R2802	#4	R2808
2-0	R2803	#5	R2809
1-0	R2804	#6	R2810



Spinal Fusion Curettes - Flatback

Curette Cup Size (mm), 6-0 thru #6

Size:	6-0	5-0	4-0	3-0	2-0	1-0	#1	#2	#3	#4	#5	#6
W x L:	1.5 x 2.5	2.0 x 3.0	2.3 x 3.5	2.8 x 3.9	3.0 x 4.6	3.3 x 5.0	4.1 x 6.9	5.0 x 7.5	5.5 x 8.4	7.5 x 10.9	8.8 x 12.5	9.9 x 14.5
	0	0	0	0	0	0	0	0	0	0	0	0

The design of the RUGGLES™ Flatback Curettes has eliminated the bulk at the back of the curette thus allowing the curette to become more maneuverable and efficient in the removing of the disc material.

RUGGLES™ Flatback Spinal Fusion Curettes

Standard Cup, Hollow Handles



Angled 40°

Cup Size	9" (229mm)	Cup Size	9" (229mm)
6-0	R2819	#1	R2825
5-0	R2820	#2	R2826
4-0	R2821	#3	R2827
3-0	R2822	#4	R2828
2-0	R2823	#5	R2829
1-0	R2824	#6	R2830



Spinal Fusion Curettes - Flatback

Curette Cup Size (mm), 6-0 thru #6

Size:	6-0	5-0	4-0	3-0	2-0	1-0	#1	#2	#3	#4	#5	#6
W x L:	1.5 x 2.5	2.0 x 3.0	2.3 x 3.5	2.8 x 3.9	3.0 x 4.6	3.3 x 5.0	4.1 x 6.9	5.0 x 7.5	5.5 x 8.4	7.5 x 10.9	8.8 x 12.5	9.9 x 14.5

RUGGLES™ Flatback Spinal Fusion Curettes

Standard Cup, Hollow Handles



R2845

Angled 90°

Cup Size	9" (229mm)	Cup Size	9" (229mm)
6-0	R2839	#1	R2845
5-0	R2840	#2	R2846
4-0	R2841	#3	R2847
3-0	R2842	#4	R2848
2-0	R2843	#5	R2849
1-0	R2844		



R2855

Reverse-Angle

Cup Size	9" (229mm)	Cup Size	9" (229mm)
5-0	R2850	#1	R2855
4-0	R2851	#2	R2856
3-0	R2852	#3	R2857
2-0	R2853	#4	R2858
1-0	R2854	#5	R2859

RUGGLES™ Spinal Fusion Curette Tray

R8113	Single Level Holds 10- 9" Curettes
R8114	Double Level Holds 20- 9" Curettes
RS0900	Single Level Holds 12- 8" or 9" Curettes

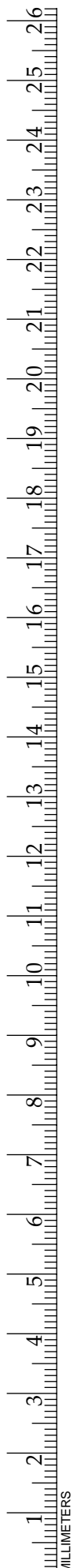

Scoville Ruptured Disc Curettes

Curette Cup Size (mm), 6-0 thru #6

Size:	6-0	5-0	4-0	3-0	2-0	1-0	#1	#2	#3	#4	#5	#6
W x L:	1.5 x 2.5	2.0 x 3.0	2.3 x 3.5	2.8 x 3.9	3.0 x 4.6	3.3 x 5.0	4.1 x 6.9	5.0 x 7.5	5.5 x 8.4	7.5 x 10.9	8.8 x 12.5	9.9 x 14.5

RUGGLES™ Scoville Ruptured Disc Curettes

Standard Cup, Hollow Handles



4 x 10mm Cup

RN0962

10"
(254mm)

Straight	RN0960
Lateral	RN0961
Angled	RN0962

RUGGLES™ Scoville Ruptured Disc Curettes

Standard Cup, Hollow Handles



#2 Cup

R0370

10"
(254mm)

Straight	R0370
Reverse-Angled	R0371
Angled	R0372



Spinal Fusion Curettes - Hollow Handle

Curette Cup Size (mm), 6-0 thru #6

Size:	6-0	5-0	4-0	3-0	2-0	1-0	#1	#2	#3	#4	#5	#6
W x L:	1.5 x 2.5	2.0 x 3.0	2.3 x 3.5	2.8 x 3.9	3.0 x 4.6	3.3 x 5.0	4.1 x 6.9	5.0 x 7.5	5.5 x 8.4	7.5 x 10.9	8.8 x 12.5	9.9 x 14.5
	0	0	0	0	0	0	0	0	0	0	0	0

RUGGLES™ Spinal Fusion Curettes

Standard Cup, Hollow Handles



Straight

R2008

Cup Size	12" (305mm)	Cup Size	12" (305mm)
3-0	R2000	#1	R2003
2-0	R2001	#2	R2004
1-0	R2002	#3	R2005
		#4	R2006
		#5	R2007
		#6	R2008



Angled

R2018

Cup Size	12" (305mm)	Cup Size	12" (305mm)
3-0	R2010	#1	R2013
2-0	R2011	#2	R2014
1-0	R2012	#3	R2015
		#4	R2016
		#5	R2017
		#6	R2018

RUGGLES™ Spinal Fusion Curette Tray

R6523 Single Level
Holds 14- 12" Curettes

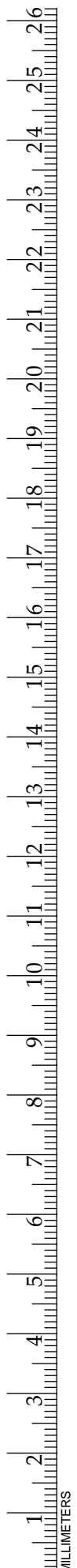

Thoraco-Lumbar Curettes

Curette Cup Size (mm), 6-0 thru #6

Size:	6-0	5-0	4-0	3-0	2-0	1-0	#1	#2	#3	#4	#5	#6
W x L:	1.5 x 2.5	2.0 x 3.0	2.3 x 3.5	2.8 x 3.9	3.0 x 4.6	3.3 x 5.0	4.1 x 6.9	5.0 x 7.5	5.5 x 8.4	7.5 x 10.9	8.8 x 12.5	9.9 x 14.5
	0	0	0	0	0	0	0	0	0	0	0	0

RUGGLES™ Thoraco-Lumbar Curettes

Resin Handles

Straight



R6513

Straight

Cup Size	12" (305mm)	Cup Size	12" (305mm)
2-0	R6513	#1	R6511
1-0	R6512	#2	R6510

Angled

Cup Size	12" (305mm)	Cup Size	12" (305mm)
2-0	R6517	#1	R6515
1-0	R6516	#2	R6514

Angled



R6516

Reverse-Angle

Cup Size	12" (305mm)	Cup Size	12" (305mm)
2-0	R6521	#1	R6519
1-0	R6520	#2	R6518

Reverse-Angle



R6518

Dissector-Angle

Cup Size	12" (305mm)
Large	R6506
Small	R6507

Dissector-Angle



R6507

RUGGLES™ Spinal Fusion Curette Tray

R6523 Single Level
Holds 14- 12" Curettes



Extended Reach Curettes

Curette Cup Size (mm), 6-0 thru #6

Size:	6-0	5-0	4-0	3-0	2-0	1-0	#1	#2	#3	#4	#5	#6
W x L:	1.5 x 2.5	2.0 x 3.0	2.3 x 3.5	2.8 x 3.9	3.0 x 4.6	3.3 x 5.0	4.1 x 6.9	5.0 x 7.5	5.5 x 8.4	7.5 x 10.9	8.8 x 12.5	9.9 x 14.5
	0	0	0	0	0	0	0	0	0	0	0	0

RUGGLES™ Apfelbaum Extended Reach Curettes

Aluminum Handles



RN1171

Angled

Handle Color	Cup Size	Reach	12"	14 1/2"
			(305mm)	(368mm)
Red	4-0	5mm	RN1171	RN1181
Blue	4-0	6mm	RN1172	RN1182
Gold	4-0	7mm	RN1173	RN1183

RN1170 12" Set including items RN1171, RN1172 and RN1173

RN1180 14 1/2" Set including items RN1181, RN1182 and RN1183

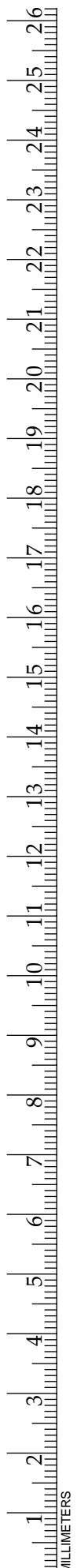

Cobb Style Bone Curettes

Curette Cup Size (mm), 6-0 thru #6

Size:	6-0	5-0	4-0	3-0	2-0	1-0	#1	#2	#3	#4	#5	#6
W x L:	1.5 x 2.5	2.0 x 3.0	2.3 x 3.5	2.8 x 3.9	3.0 x 4.6	3.3 x 5.0	4.1 x 6.9	5.0 x 7.5	5.5 x 8.4	7.5 x 10.9	8.8 x 12.5	9.9 x 14.5
	0	0	0	0	0	0	0	0	0	0	0	0

RUGGLES™ Cobb Style Bone Curettes

Solid, Knurled Handle



Straight

Cup Size	11" (279mm)	Cup Size	11" (279mm)
3-0	R2220	#1	R2223
2-0	R2221	#2	R2224
1-0	R2222	#3	R2225
		#4	R2226
		#5	R2227
		#6	R2228



Curettes

Cobb Style Bone Curettes

Curette Cup Size (mm), 6-0 thru #6

Size:	6-0	5-0	4-0	3-0	2-0	1-0	#1	#2	#3	#4	#5	#6
W x L:	1.5 x 2.5	2.0 x 3.0	2.3 x 3.5	2.8 x 3.9	3.0 x 4.6	3.3 x 5.0	4.1 x 6.9	5.0 x 7.5	5.5 x 8.4	7.5 x 10.9	8.8 x 12.5	9.9 x 14.5
	0	0	0	0	0	0	0	0	0	0	0	0

RUGGLES™ Cobb Style Bone Curettes

Solid, Knurled Handle



R2234

Angled

Cup Size	11" (279mm)	Cup Size	11" (279mm)
3-0	R2230	#1	R2233
2-0	R2231	#2	R2234
1-0	R2232	#3	R2235
		#4	R2236
		#5	R2237
		#6	R2238

RUGGLES™ Cobb Curette Tray

R2250 Holds 9-11" Curettes



Cervical Axial Curettes

RUGGLES™ Cervical Axial Curettes

Solid, Angled Handle, 4 1/2"(114mm) Shaft with Flatback Cups

Angled Up

Cup Size	9" (229mm)
6-0	R8800
5-0	R8801
4-0	R8802

Cup Size	9" (229mm)
3-0	R8803
2-0	R8804
1-0	R8805



Angled Up

R8805

Angled Down

Cup Size	9" (229mm)
6-0	R8806
5-0	R8807
4-0	R8808

Cup Size	9" (229mm)
3-0	R8809
2-0	R8810
1-0	R8811

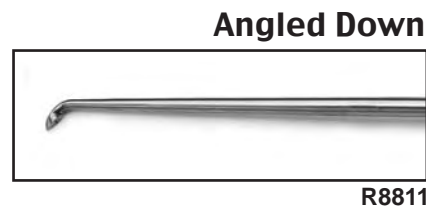

Angled Down

R8811

Straight Up

Cup Size	9" (229mm)
6-0	R8812
5-0	R8813
4-0	R8814

Cup Size	9" (229mm)
3-0	R8815
2-0	R8817
1-0	R8818

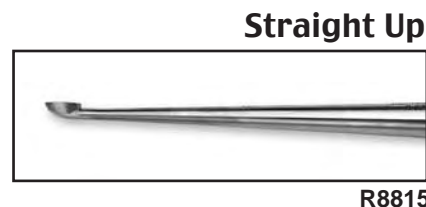

Straight Up

R8815

Straight Down

Cup Size	9" (229mm)
6-0	R8819
5-0	R8820
4-0	R8821

Cup Size	9" (229mm)
3-0	R8822
2-0	R8823
1-0	R8824

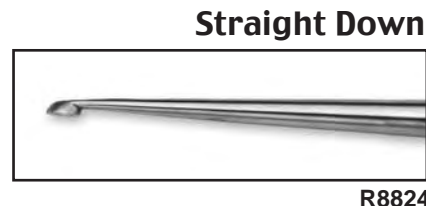

Straight Down

R8824

Reverse-Angle Up

Cup Size	9" (229mm)
6-0	R8825
5-0	R8826
4-0	R8827

Cup Size	9" (229mm)
3-0	R8828
2-0	R8829
1-0	R8830

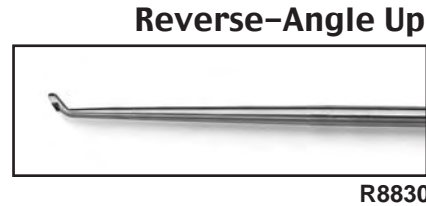

Reverse-Angle Up

R8830

Reverse-Angle Down

Cup Size	9" (229mm)
6-0	R8831
5-0	R8832
4-0	R8833

Cup Size	9" (229mm)
3-0	R8834
2-0	R8835
1-0	R8836

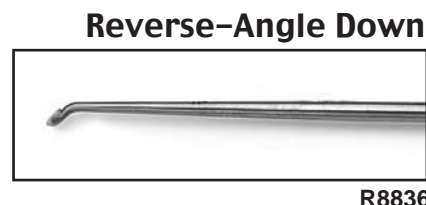

Reverse-Angle Down

R8836

RUGGLES™ Cervical Axial Curette Tray

R8117 Cervical Axial Curettes Tray
Holds 10 Cervical Axial Curettes



Lumbar Axial Curettes- Small Cup

RUGGLES™ Lumbar Axial Curettes, Small Cup

Solid, Angled Handle, 5 1/2" (140mm) Shaft with Flatback Cups

Angled Up

Cup Size	10 1/4" (260mm)	Cup Size	10 1/4" (260mm)
6-0	R8770	3-0	R8773
5-0	R8771	2-0	R8774
4-0	R8772	1-0	R8775



R8770

Angled Down

Cup Size	10 1/4" (260mm)	Cup Size	10 1/4" (260mm)
6-0	R8780	3-0	R8783
5-0	R8781	2-0	R8784
4-0	R8782	1-0	R8785

Angled Down



R8781

Straight Up

Cup Size	10 1/4" (260mm)	Cup Size	10 1/4" (260mm)
6-0	R8786	3-0	R8789
5-0	R8787	2-0	R8790
4-0	R8788	1-0	R8791

Straight Up



R8787

Straight Down

Cup Size	10 1/4" (260mm)	Cup Size	10 1/4" (260mm)
6-0	R8792	3-0	R8795
5-0	R8793	2-0	R8796
4-0	R8794	1-0	R8797

Straight Down



R8793

Reverse-Angle Up

Cup Size	10 1/4" (260mm)	Cup Size	10 1/4" (260mm)
6-0	R8763	3-0	R8766
5-0	R8764	2-0	R8767
4-0	R8765	1-0	R8768

Reverse-Angle Up

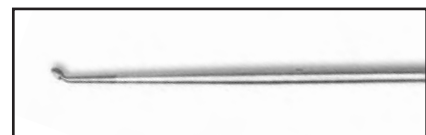

R8767

Reverse-Angle Down

Cup Size	10 1/4" (260mm)	Cup Size	10 1/4" (260mm)
6-0	R8776	3-0	R8779
5-0	R8777	2-0	R8798
4-0	R8778	1-0	R8799

Reverse-Angle Down



R8777

RUGGLES™ Lumbar Axial Curette Tray

R8118 Lumbar Axial Curettes tray
Holds 10 Lumbar Axial Curettes

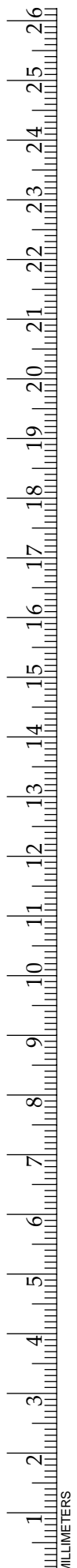

Lumbar Axial Curettes- Large Cup

RUGGLES™ Lumbar Axial Curettes, Large Cup

Solid, Angled Handle, 5 1/2" (140mm) Shaft with Flatback Cups

Angled Up

Cup Size	10 1/2" (267mm)
#5	R6740
#4	R6741
#3	R6742

Cup Size	10 1/2" (267mm)
#2	R6743
#1	R6744



Angled Up

R6743

Angled Down

Cup Size	10 1/2" (267mm)
#5	R6745
#4	R6746
#3	R6747

Cup Size	10 1/2" (267mm)
#2	R6748
#1	R6749



Angled Down

R6746

Straight Up

Cup Size	10 1/2" (267mm)
#5	R6750
#4	R6751
#3	R6752

Cup Size	10 1/2" (267mm)
#2	R6753
#1	R6754



Straight Up

R6754

Straight Down

Cup Size	10 1/2" (267mm)
#5	R6755
#4	R6756
#3	R6757

Cup Size	10 1/2" (267mm)
#2	R6758
#1	R6759

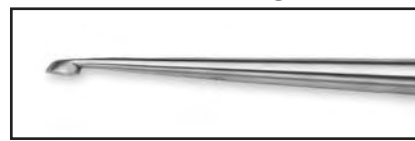

Straight Down

R6759

Reverse-Angle Up

Cup Size	10 1/2" (267mm)
#5	R6530
#4	R6532
#3	R6534

Cup Size	10 1/2" (267mm)
#2	R6536
#1	R6538



Reverse-Angle Up

R6532

Reverse-Angle Down

Cup Size	10 1/2" (267mm)
#5	R6531
#4	R6533
#3	R6535

Cup Size	10 1/2" (267mm)
#2	R6537
#1	R6539



Reverse-Angle Down

R6539

RUGGLES™ Lumbar Axial Curette Tray

R8118 Lumbar Axial Curettes tray
Holds 10 Lumbar Axial Curettes



Microsurgical Curettes

Curette Cup Size (mm), 6-0 thru #6

Size:	6-0	5-0	4-0	3-0	2-0	1-0	#1	#2	#3	#4	#5	#6
W x L:	1.5 x 2.5	2.0 x 3.0	2.3 x 3.5	2.8 x 3.9	3.0 x 4.6	3.3 x 5.0	4.1 x 6.9	5.0 x 7.5	5.5 x 8.4	7.5 x 10.9	8.8 x 12.5	9.9 x 14.5
	0	0	0	0	0	0	0	0	0	0	0	0

RUGGLES™ Micro-Angled Curettes

Standard, Hollow Handle



RN0986

Straight

Angled

Cup Size **9"**
(229mm)

Cup Size **9"**
(229mm)

5-0	RN0981
4-0	RN0982
3-0	RN0983

5-0	RN0986
4-0	RN0987
3-0	RN0988

RUGGLES™ Micro-Bayonet Curettes

Standard, Hollow Handle



RN0883

Straight

Angled

Reverse-Angle

Cup Size **9"**
(229mm)

Cup Size **9"**
(229mm)

Cup Size **9"**
(229mm)

5-0	RN0881
4-0	RN0882
3-0	RN0883

5-0	RN0886
4-0	RN0887
3-0	RN0888

5-0	RN0897
4-0	RN0898
3-0	RN0899

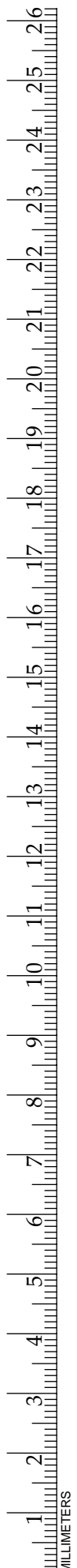

Microsurgical Curettes

Curette Cup Size (mm), 6-0 thru #6

Size:	6-0	5-0	4-0	3-0	2-0	1-0	#1	#2	#3	#4	#5	#6
W x L:	1.5 x 2.5	2.0 x 3.0	2.3 x 3.5	2.8 x 3.9	3.0 x 4.6	3.3 x 5.0	4.1 x 6.9	5.0 x 7.5	5.5 x 8.4	7.5 x 10.9	8.8 x 12.5	9.9 x 14.5
	0	0	0	0	0	0	0	0	0	0	0	0

RUGGLES™ Round Bayonet Handle Micro Curettes

Straight

Cup	9 1/2" (240mm)
Straight	R7350
45° Angle	R7351
90° Angle	R7352
Curved Up	R7353



45° Angle

Stick	Cup	9 1/2" (240mm)
5mm	3mm Up	R7360
5mm	3mm Down	R7361
5mm	3mm Right	R7362
5mm	3mm Left	R7363



90° Angle

Stick	Cup	9 1/2" (229mm)
5mm	3mm Up	R7365
5mm	3mm Down	R7366
5mm	3mm Right	R7367
5mm	3mm Left	R7368



45° Angle

Stick	Cup	9 1/2" (240mm)
10mm	3mm Up	R7370
10mm	3mm Down	R7371
10mm	3mm Right	R7372
10mm	3mm Left	R7373



Cone Ring Curettes

Curette Ring Size (mm)

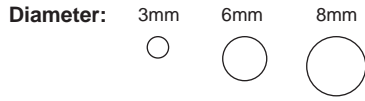

RUGGLES™ Cone Ring Curettes

Solid, Knurled Handle

Straight

Ring Size 9"
(229mm)

Size 1 (8mm) **RN0991**

Size 2 (6mm) **RN0992**

Size 3 (3mm) **RN0993**



RN0992

Angled

Cup Size 9"
(229mm)

Size 1 (8mm) **RN0994**

Size 2 (6mm) **RN0995**

Size 3 (3mm) **RN0996**



RN0994

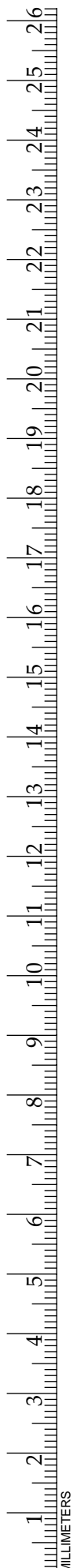

Specialty Curettes

Curette Cup Size (mm), 6-0 thru #6

Size:	6-0	5-0	4-0	3-0	2-0	1-0	#1	#2	#3	#4	#5	#6
W x L:	1.5 x 2.5	2.0 x 3.0	2.3 x 3.5	2.8 x 3.9	3.0 x 4.6	3.3 x 5.0	4.1 x 6.9	5.0 x 7.5	5.5 x 8.4	7.5 x 10.9	8.8 x 12.5	9.9 x 14.5
	0	0	0	0	0	0	0	0	0	0	0	0

RUGGLES™ Semmes Spinal Fusion Curettes

Solid Handle, Oval Ring

5 x 8mm Ring

9"

(229mm)

Straight **RN0945**

Slightly Angled **RN0946**

Fully Angled **RN0947**



RN0945

RUGGLES™ Epstein Curettes

Standard, Hollow Handle, Reverse Angle

8"

Cup Size (203mm)

3-0 **RN0820**

2-0 **RN0821**

1-0 **RN0822**



RN0820



Sisco Bayonet Curettes

Curette Cup Size (mm), 6-0 thru #6

Size:	6-0	5-0	4-0	3-0	2-0	1-0	#1	#2	#3	#4	#5	#6
W x L:	1.5 x 2.5	2.0 x 3.0	2.3 x 3.5	2.8 x 3.9	3.0 x 4.6	3.3 x 5.0	4.1 x 6.9	5.0 x 7.5	5.5 x 8.4	7.5 x 10.9	8.8 x 12.5	9.9 x 14.5
	0	0	0	0	0	0	0	0	0	0	0	0

RUGGLES™ Sisco Bayonet Curettes

Standard, Hollow Handle

Straight

Straight



Cup Size	9" (229mm)	Cup Size	9" (229mm)
6-0	R2871	3-0	R2874
5-0	R2872	2-0	R2875
4-0	R2873	1-0	R2876

R2872

40° Angled

Cup Size	9" (229mm)	Cup Size	9" (229mm)
6-0	R2891	3-0	R2894
5-0	R2892	2-0	R2895
4-0	R2893	1-0	R2896

40° Angle



R2892

90° Angled

Cup Size	9" (229mm)	Cup Size	9" (229mm)
6-0	R2870	3-0	R2862
5-0	R2860	2-0	R2863
4-0	R2861	1-0	R2864

90° Angled



R2861

Reverse-Angle Up

Cup Size	9" (229mm)	Cup Size	9" (229mm)
6-0	R2865	3-0	R2868
5-0	R2866	2-0	R2877
4-0	R2867	1-0	R2878

Reverse-Angle Up



R2867

Reverse-Angle Down

Cup Size	9" (229mm)	Cup Size	9" (229mm)
6-0	R2881	3-0	R2884
5-0	R2882	2-0	R2885
4-0	R2883	1-0	R2886

Reverse-Angle Down



R2883

RUGGLES™ Sisco Bayonet Curette Tray

R8113 Single Level
Holds 9-9" Bayonet Curettes

R8114 Double Level
Holds 18-9" Bayonet Curettes

SUCTION TUBES



SUCTION TUBES

	○	○	○	○	○	○	○	○	○	○	○
French	03 Fr	04 Fr	05 Fr	06 Fr	07 Fr	08 Fr	09 Fr	10 Fr	11 Fr	12 Fr	15 Fr
Inches	.039	.053	.066	.079	.092	.105	.118	.131	.144	.158	.197
Millimeters	1	1.35	1.67	2.0	2.3	2.7	3.0	3.3	3.7	4.0	5.0

WL= Working Length
HL= Hub Length
OL= Overall Length

RUGGLES™ Frazier Suction Tubes

Semi-Rigid with Hole



RN85612

Straight

	WL: 5 1/2" (140mm)	7" (178mm)
	HL: 5 1/2" (140mm)	7" (178mm)
Diameter	OL: 8" (203mm)	9 1/2" (241mm)

	WL: 5 1/2" (140mm)	7" (178mm)
	HL: 5 1/2" (140mm)	7" (178mm)
Diameter	OL: 8" (203mm)	9 1/2" (241mm)

03 Fr.	RN8563	RN8763
04 Fr.	RN8564	RN8764
05 Fr.	RN8565	RN8765
06 Fr.	RN8566	RN8766
07 Fr.	RN8567	RN8767

08 Fr.	RN8568	RN8768
09 Fr.	RN8569	RN8769
10 Fr.	RN85610	RN87610
11 Fr.	RN85611	RN87611
12 Fr.	RN85612	RN87612



Angled

	WL: 4" (102mm)	5 1/2" (140mm)
	HL: 5 1/2" (140mm)	7" (178mm)
Diameter	OL: 7" (178mm)	8 1/2" (216mm)

	WL: 4" (102mm)	5 1/2" (140mm)
	HL: 5 1/2" (140mm)	7" (178mm)
Diameter	OL: 7" (178mm)	8 1/2" (216mm)

03 Fr.	RN8583	RN8783
04 Fr.	RN8584	RN8784
05 Fr.	RN8585	RN8785
06 Fr.	RN8586	RN8786
07 Fr.	RN8587	RN8787

08 Fr.	RN8588	RN8788
09 Fr.	RN8589	RN8789
10 Fr.	RN85810	RN87810
11 Fr.	RN85811	RN87811
12 Fr.	RN85812	RN87812

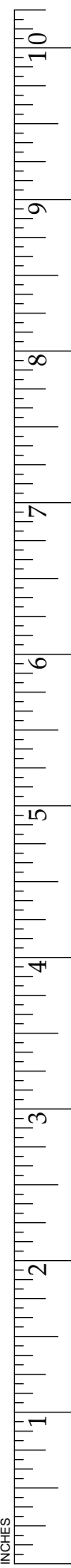

Suction Tubes

	○	○	○	○	○	○	○	○	○	○	○
French	03 Fr	04 Fr	05 Fr	06 Fr	07 Fr	08 Fr	09 Fr	10 Fr	11 Fr	12 Fr	15 Fr
Inches	.039	.053	.066	.079	.092	.105	.118	.131	.144	.158	.197
Millimeters	1	1.35	1.67	2.0	2.3	2.7	3.0	3.3	3.7	4.0	5.0

WL= Working Length
HL= Hub Length
OL= Overall Length

RUGGLES™ Frazier Suction Tubes

Semi-Rigid with Slot

Straight



RN8512

Diameter	WL: 5 1/2" (140mm)	HL: 5 1/2" (140mm)	OL: 7 3/4" (197mm)	7" (178mm)	HL: 5 1/2" (140mm)	WL: 5 1/2" (140mm)	HL: 5 1/2" (140mm)	OL: 7 3/4" (197mm)	7" (178mm)	9 1/4" (235mm)
----------	--------------------	--------------------	--------------------	------------	--------------------	--------------------	--------------------	--------------------	------------	----------------

03 Fr.	RN8503	RN8703	08 Fr.	RN8508	RN8708
04 Fr.	RN8504	RN8704	09 Fr.	RN8509	RN8709
05 Fr.	RN8505	RN8705	10 Fr.	RN8510	RN8710
06 Fr.	RN8506	RN8706	11 Fr.	RN8511	RN8711
07 Fr.	RN8507	RN8707	12 Fr.	RN8512	RN8712

Angled



RN8523

Diameter	WL: 4 3/8" (111mm)	HL: 5 1/2" (140mm)	OL: 7" (178mm)	5 3/4" (146mm)	HL: 5 1/2" (140mm)	WL: 4 3/8" (111mm)	HL: 5 1/2" (140mm)	OL: 7" (178mm)	8 1/2" (216mm)
----------	--------------------	--------------------	----------------	----------------	--------------------	--------------------	--------------------	----------------	----------------

03 Fr.	RN8523	RN8723
04 Fr.	RN8524	RN8724
05 Fr.	RN8525	RN8725
06 Fr.	RN8526	RN8726
07 Fr.	RN8527	RN8727
08 Fr.	RN8528	RN8728
09 Fr.	RN8529	RN8729
10 Fr.	RN85210	RN87210
11 Fr.	RN85211	RN87211
12 Fr.	RN85212	RN87212

	○	○	○	○	○	○	○	○	○	○	○
French	03 Fr	04 Fr	05 Fr	06 Fr	07 Fr	08 Fr	09 Fr	10 Fr	11 Fr	12 Fr	15 Fr
Inches	.039	.053	.066	.079	.092	.105	.118	.131	.144	.158	.197
Millimeters	1	1.35	1.67	2.0	2.3	2.7	3.0	3.3	3.7	4.0	5.0

WL= Working Length
HL= Hub Length
OL= Overall Length

RUGGLES™ Frazier Suction Tubes

Malleable with Hole

Angled

Diameter	WL: 4 3/8" (111mm)	5 3/4" (146mm)
	HL: 5 1/2" (140mm)	7" (178mm)
	OL: 7 3/4" (197mm)	9" (229mm)

03 Fr.	R0708	R0778
05 Fr.	R0707	R0777
06 Fr.	R0710	R0770
07 Fr.	R0711	R0771
08 Fr.	R0712	R0772
09 Fr.	R0713	R0773
10 Fr.	R0714	R0774
11 Fr.	R0715	R0775
12 Fr.	R0716	R0776



RUGGLES™ Poppen Suction Tubes

Malleable with Slot

Angled

Diameter	WL: 4 3/8" (111mm)	5 3/4" (146mm)
	HL: 5 1/2" (140mm)	7" (178mm)
	OL: 7 3/4" (197mm)	9" (229mm)

06 Fr.	R0658	R0785
07 Fr.	R0659	R0786
08 Fr.	R0660	R0787
09 Fr.	R0661	R0788
10 Fr.	R0662	R0789
11 Fr.	R0663	R0790
12 Fr.	R0664	R0791

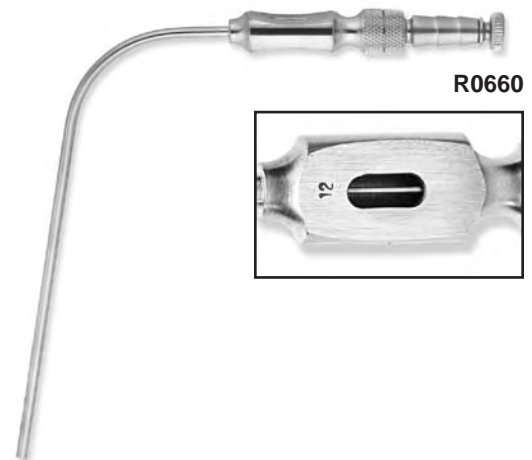

Suction Tubes

	○	○	○	○	○	○	○	○	○	○	○
French	03 Fr	04 Fr	05 Fr	06 Fr	07 Fr	08 Fr	09 Fr	10 Fr	11 Fr	12 Fr	15 Fr
Inches	.039	.053	.066	.079	.092	.105	.118	.131	.144	.158	.197
Millimeters	1	1.35	1.67	2.0	2.3	2.7	3.0	3.3	3.7	4.0	5.0

WL= Working Length
HL= Hub Length
OL= Overall Length

RUGGLES™ Atraumatic Tip Suction Tubes with Multiple Holes

Malleable

Angled

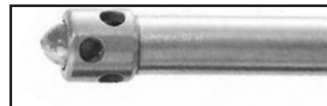

Tip

WL: 6" (135mm)

HL: 7" (178mm)

Diameter OL: 9 1/2" (241mm)

03 Fr.	R0674
05 Fr.	R0675
06 Fr.	R0676
07 Fr.	R0677
08 Fr.	R0678
09 Fr.	R0679
10 Fr.	R0680
11 Fr.	R0681
12 Fr.	R0682

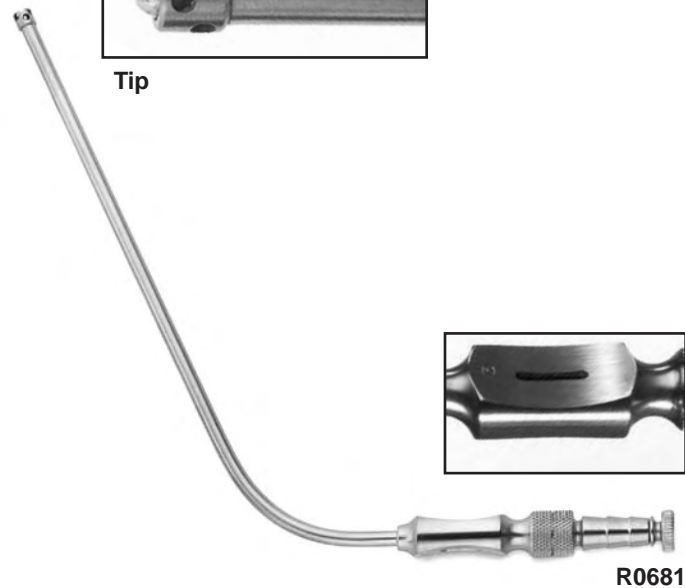

R0681



	○	○	○	○	○	○	○	○	○	○	○
French	03 Fr	04 Fr	05 Fr	06 Fr	07 Fr	08 Fr	09 Fr	10 Fr	11 Fr	12 Fr	15 Fr
Inches	.039	.053	.066	.079	.092	.105	.118	.131	.144	.158	.197
Millimeters	1	1.35	1.67	2.0	2.3	2.7	3.0	3.3	3.7	4.0	5.0

WL= Working Length
HL= Hub Length
OL= Overall Length

RUGGLES™ Atraumatic Tip Suction Tubes

Angled

	WL: 3 1/8" (79mm)	4" (102mm)	4 3/4" (121mm)
	HL: 4 1/4" (108mm)	5" (127mm)	6 1/4" (159mm)
Diameter	OL: 6" (152mm)	6 3/4" (171mm)	8" (203mm)

03 Fr.	RN9103	RN9203	RN9303
05 Fr.	RN9105	RN9205	RN9305
07 Fr.	RN9107	RN9207	RN9307
10 Fr.	RN9110	RN9210	RN9310
12 Fr.	RN9112	RN9212	RN9312

RN9307

RUGGLES™ Atraumatic Tip Suction Tubes

Curved Down

	WL: 5 1/8" (135mm)
	HL: 6 3/4" (171mm)
Diameter	OL: 8 1/4" (210mm)

05 Fr.	RN9505
07 Fr.	RN9507
10 Fr.	RN9510

RN9507

Curved Up

	WL: 5 1/8" (135mm)
	HL: 6 3/4" (171mm)
Diameter	OL: 8 1/4" (210mm)

05 Fr.	RN9405
07 Fr.	RN9407
10 Fr.	RN9410

RN9407

For Black Chrome Atraumatic Suction Tubes, change RN prefix to RA

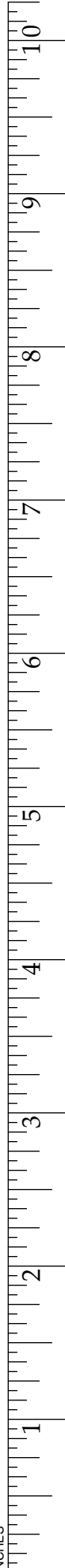

Suction Tubes

	○	○	○	○	○	○	○	○	○	○	○
French	03 Fr	04 Fr	05 Fr	06 Fr	07 Fr	08 Fr	09 Fr	10 Fr	11 Fr	12 Fr	15 Fr
Inches	.039	.053	.066	.079	.092	.105	.118	.131	.144	.158	.197
Millimeters	1	1.35	1.67	2.0	2.3	2.7	3.0	3.3	3.7	4.0	5.0

WL= Working Length
HL= Hub Length
OL= Overall Length

RUGGLES™ Multi-Hole Suction Tubes

5 Holes at Tip

Angled



WL: 4 1/2" (114mm) 6 1/2" (165mm)

HL: 5 1/4" (133mm) 7 1/4" (184mm)

Diameter OL: 7" (178mm) 8 3/4" (222mm)



RN9625

05 Fr. **RN9625** **RN9725**

07 Fr. **RN9627** **RN9727**

RUGGLES™ Adson Suction Tubes

Curved



WL: 5/8" (16mm) 3/4" (19mm)

HL: 3 1/4" (83mm) 5 1/4" (133mm)

Diameter OL: 5 1/2" (140mm) 7 1/2" (191mm)

RN8612

12 Fr. **RN8612**

15 Fr. **RN8615**

For Black Chrome Multi-Hole and Adson Suction Tubes, change RN prefix to RA

	○	○	○	○	○	○	○	○	○	○	○
French	03 Fr	04 Fr	05 Fr	06 Fr	07 Fr	08 Fr	09 Fr	10 Fr	11 Fr	12 Fr	15 Fr
Inches	.039	.053	.066	.079	.092	.105	.118	.131	.144	.158	.197
Millimeters	1	1.35	1.67	2.0	2.3	2.7	3.0	3.3	3.7	4.0	5.0

RUGGLES™ Endonasal Suction Tubes

- Teardrop shaped control slot allows for extremely precise regulation of suction.
- Four different pre-set curves permit suctioning of entire site.
- Malleable shaft gives the surgeon additional flexibility to adjust the configuration of the suction tube as necessary, allowing access in cases where difficult patient anatomy or tumor location may be impossible for standard suction tubes to reach.

WL= Working Length
HL= Hub Length
OL= Overall Length

Short Curve Up

WL: 4 3/4" (121mm)
HL: 5 1/2" (140mm)

Diameter OL: 8" (203mm)

05 Fr. **RN82325**

07 Fr. **RN82327**

Long Curve Up

WL: 4 3/4" (121mm)
HL: 5 1/2" (140mm)

Diameter OL: 8" (203mm)

05 Fr. **RN82425**

07 Fr. **RN82427**

Straight

WL: 4 3/4" (121mm)
HL: 5 1/2" (140mm)

Diameter OL: 8" (203mm)

05 Fr. **RN82525**

07 Fr. **RN82527**

11 Fr. **RN825211**

Short Curve Down

WL: 4 3/4" (121mm)
HL: 5 1/2" (140mm)

Diameter OL: 8" (203mm)

05 Fr. **RN82625**

07 Fr. **RN82627**

Long Curve Down

WL: 4 3/4" (121mm)
HL: 5 1/2" (140mm)

Diameter OL: 8" (203mm)

05 Fr. **RN82725**

07 Fr. **RN82727**

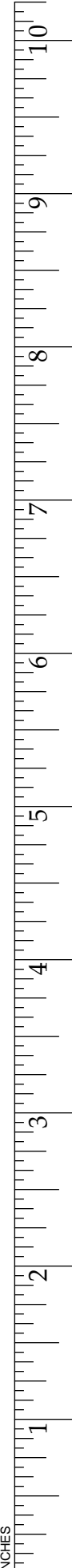
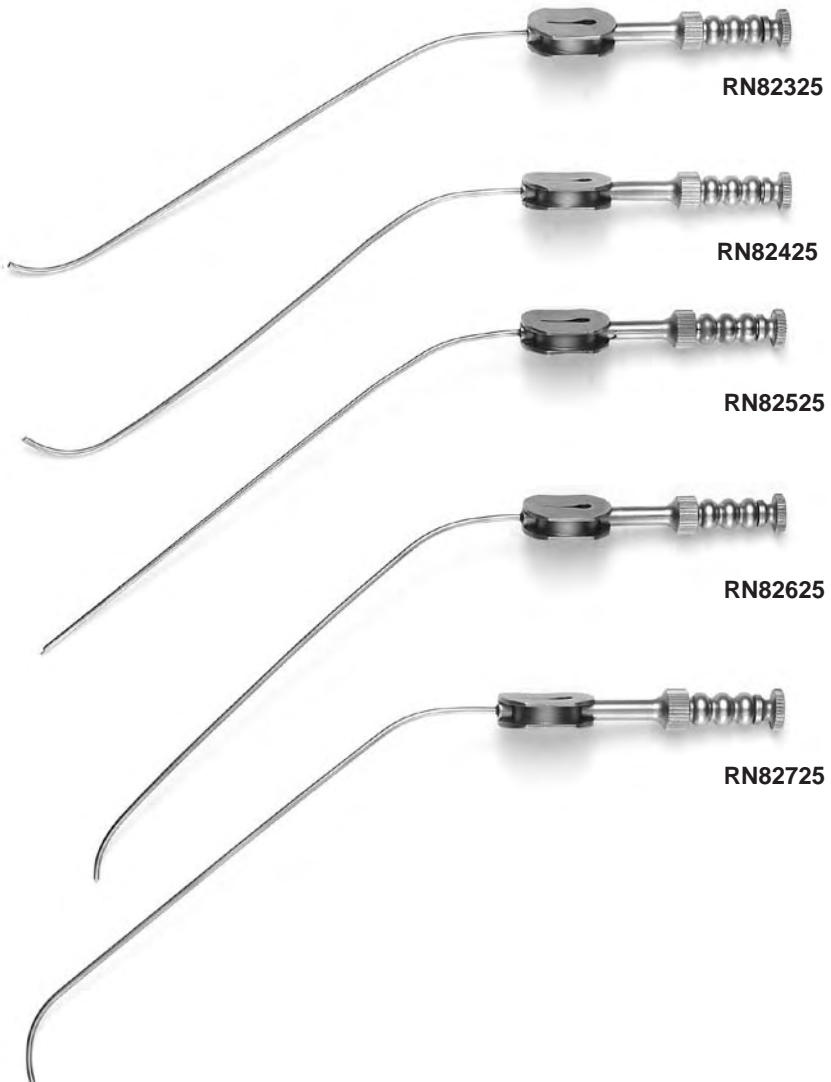

Suction Tubes

	○	○	○	○	○	○	○	○	○	○	○
French	03 Fr	04 Fr	05 Fr	06 Fr	07 Fr	08 Fr	09 Fr	10 Fr	11 Fr	12 Fr	15 Fr
Inches	.039	.053	.066	.079	.092	.105	.118	.131	.144	.158	.197
Millimeters	1	1.35	1.67	2.0	2.3	2.7	3.0	3.3	3.7	4.0	5.0

WL= Working Length
HL= Hub Length
OL= Overall Length

RUGGLES™ Bayonet Suction Tubes

Left Finger Control

WL: 3 3/8" (86mm)

HL: 5" (127mm)

Diameter OL: 8 1/2" (216mm)



RN9001L

05 Fr. RN9001L

07 Fr. RN9002L

09 Fr. RN9003L

RN9000L Set of 3 Bayonet Suction Tubes

Right Finger Control

WL: 3 3/8" (86mm)

HL: 5" (127mm)

Diameter OL: 8 1/2" (216mm)



RN9001R

05 Fr. RN9001R

07 Fr. RN9002R

09 Fr. RN9003R

RN9000R Set of 3 Bayonet Suction Tubes

Top Finger Control

WL: 3 3/8" (86mm)

HL: 5" (127mm)

Diameter OL: 8 1/2" (216mm)



RN9003T

05 Fr. RN9001T

07 Fr. RN9002T

09 Fr. RN9003T

RN9000T Set of 3 Bayonet Suction Tubes

For Black Chrome Bayonet Suction Tubes, change RN prefix to RA

	○	○	○	○	○	○	○	○	○	○	○
French	03 Fr	04 Fr	05 Fr	06 Fr	07 Fr	08 Fr	09 Fr	10 Fr	11 Fr	12 Fr	15 Fr
Inches	.039	.053	.066	.079	.092	.105	.118	.131	.144	.158	.197
Millimeters	1	1.35	1.67	2.0	2.3	2.7	3.0	3.3	3.7	4.0	5.0

RUGGLES™ Tapered Teardrop Suction Tubes Semi-Rigid

WL:	4 1/2" (114mm)	5 1/2" (140mm)	6 3/4" (172mm)
HL:	6 1/4" (159mm)	7" (178mm)	8" (203mm)
Diameter OL:	8 1/4" (210mm)	9 1/4" (235mm)	10 3/4" (273mm)

WL= Working Length
HL= Hub Length
OL= Overall Length



RN8264

03 Fr.	RN8253	RN8263	RN8283
04 Fr.	RN8254	RN8264	RN8284
05 Fr.	RN8255	RN8265	RN8285
06 Fr.	RN8256	RN8266	RN8286
07 Fr.	RN8257	RN8267	RN8287
08 Fr.	RN8258	RN8268	RN8288
09 Fr.	RN8259	RN8269	RN8289
10 Fr.	RN82510	RN82610	RN82810
12 Fr.	RN82512	RN82612	RN82812

RUGGLES™ T. Fukushima Tapered Teardrop Suction Tubes Malleable

	S	M	L	LL
WL:	3" (76mm)	3 1/2" (89mm)	4 1/2" (114mm)	5 1/2" (140mm)
HL:	4 1/4" (108mm)	4 3/4" (121mm)	5 3/4" (146mm)	6 3/4" (171mm)
Diameter OL:	6 1/2" (165mm)	7" (178mm)	8" (203mm)	9" (229mm)



R8966

02Fr.	R9007	R9008	R9009	R9010
03 Fr.	R9000	R9001	R9002	R9003
04 Fr.	R8980	R8986	R8992	R9004
05 Fr.	R8981	R8987	R8993	R9005
06 Fr.	R8982	R8988	R8994	R9006
07 Fr.	R8983	R8989	R8995	R8965
08 Fr.	R8984	R8990	R8996	R8966
09 Fr.	R8985	R8991	R8997	R8967
10 Fr.	R9042	R9044	R9046	R8968
11 Fr.				R8969
12 Fr.	R9043	R9045	R9047	R8970

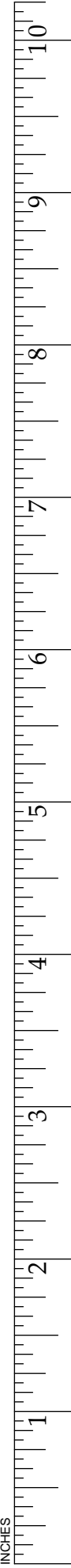

Suction Tubes

	○	○	○	○	○	○	○	○	○	○	○
French	03 Fr	04 Fr	05 Fr	06 Fr	07 Fr	08 Fr	09 Fr	10 Fr	11 Fr	12 Fr	15 Fr
Inches	.039	.053	.066	.079	.092	.105	.118	.131	.144	.158	.197
Millimeters	1	1.35	1.67	2.0	2.3	2.7	3.0	3.3	3.7	4.0	5.0

RUGGLES™ Tapered Teardrop Suction Tubes Super Malleable, Plated Brass

WL= Working Length
HL= Hub Length
OL= Overall Length



	WL: 5 3/4" (146mm)	6 1/4" (159mm)	7" (114mm)	8" (203mm)	R9008SM
	HL: 5 3/4" (146mm)	6 1/4" (159mm)	7" (146mm)	8" (203mm)	
Diameter	OL: 8 1/4" (210mm)	8 3/4" (222mm)	9 1/2" (241mm)	10 1/2" (267mm)	

02Fr.	R9012SM	R9007SM	R9008SM	R9009SM
03 Fr.	R9013SM	R9000SM	R9001SM	R9002SM
04 Fr.	R9014SM	R8980SM	R8986SM	R8992SM
05 Fr.	R9015SM	R8981SM	R8987SM	R8993SM
06 Fr.	R9016SM	R8982SM	R8988SM	R8994SM
07 Fr.	R9017SM	R8983SM	R8989SM	R8995SM
08 Fr.	R9018SM	R8984SM	R8990SM	R8996SM
09 Fr.	R9019SM	R8985SM	R8991SM	R8997SM
10 Fr.	R9020SM	R9042SM	R9044SM	R9046SM
12 Fr.	R9021SM	R9043SM	R9045SM	R9047SM

RUGGLES™ Suction Nerve Retractors

	Blade	Length	Catalog #
7Fr	6mm	8" (203mm)	RN2211
7Fr	7mm	8" (203mm)	RN2212
7Fr	8mm	8" (203mm)	RN2213



RN2213

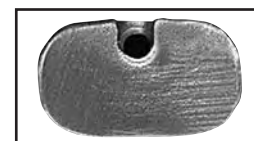

Suction Nerve Retractor Set (3) RN2210

Includes one (1) each of items above

OPERATIONAL INSTRUMENTATION



OPERATIONAL INSTRUMENTATION

Neurosurgical Scissors

RUGGLES™ Dietrich Artery Scissors

Angle	Length	Catalog #
25°	7" (178mm)	R1921
45°	7" (178mm)	R1922
60°	7" (178mm)	R1923
90°	7" (178mm)	R1924

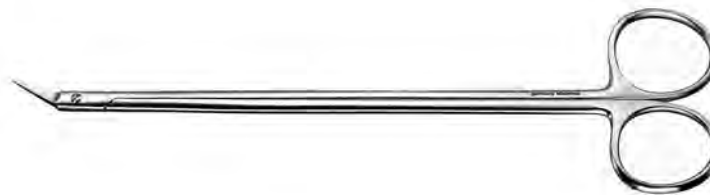

R1921

RUGGLES™ Olivecrona Alligator Scissors

Length	Catalog #
5 1/2" (140mm)	R1925



R1925

RUGGLES™ Potts–Smith Scissors

Angle	Length	Catalog #
25°	7 1/2" (191mm)	R1916
45°	7 1/2" (191mm)	R1917
60°	7 1/2" (191mm)	R1918



R1918

RUGGLES™ Metzenbaum Dissecting Scissors

Angle	Length	Catalog #
Straight	7" (178mm)	R1926



R1926



Neurosurgical Scissors

RUGGLES™ Delicate Neurosurgical Dissecting Scissors

Length	Catalog #
--------	-----------

7 1/4" (184mm)	R1920
----------------	-------



R1920

RUGGLES™ Dandy Trigeminal Scissors

Angle	Length	Catalog #
-------	--------	-----------

Double Curved	6 3/4" (171mm)	RN7218
---------------	----------------	--------

Double Curved	7 3/4" (197mm)	RN7219
---------------	----------------	--------



RN7219

RUGGLES™ Strully Neurosurgical Scissors

Length	Catalog #
--------	-----------

8" (203mm)	R1905
------------	-------



R1905

RUGGLES™ Frazier Dura Scissors

Length	Catalog #
--------	-----------

6 1/2" (165mm)	RN7217
----------------	--------



RN7217

RUGGLES™ Taylor Dura Scissors

Length	Catalog #
--------	-----------

5 3/4" (146mm)	RN7214
----------------	--------



RN7214



Forceps

RUGGLES™ Adson Dura Forceps

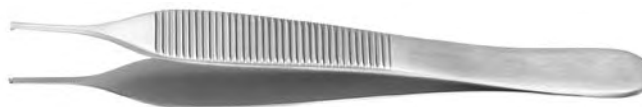

R0419

	Length	Catalog #
1 x 2 Teeth	4 3/4" (121mm)	R0427
1 x 2 Teeth, Serrated	4 3/4" (121mm)	R0419
2 x 3 Teeth	4 3/4" (121mm)	R0429
Brown Type Teeth	4 3/4" (121mm)	R0430
Cross Serrated	4 3/4" (121mm)	R0423
Serrated	4 3/4" (121mm)	R0425

RUGGLES™ Adson Forceps with Tungsten-Carbide Inserts



RT0156

	Length	Catalog #
Serrated	4 3/4" (121mm)	RT0150
1 x 2 Teeth	4 3/4" (121mm)	RT0154
1 x 2 Teeth, Delicate	4 3/4" (121mm)	RT0155
Brown Type Teeth	4 3/4" (121mm)	RT0158
1 x 2 Teeth	6" (152mm)	RT0156
Serrated	6" (152mm)	RT0157

RUGGLES™ Adson Dura Forceps

Delicate

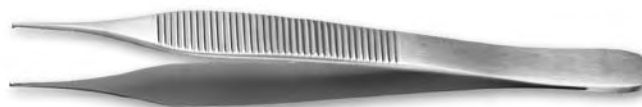

R0404

	Tip	Length	Catalog #
Dressing	8mm	4 3/4" (121mm)	R0403
Tissue	8mm	4 3/4" (121mm)	R0404



Forceps

RUGGLES™ Potts–Smith Tissue Forceps Serrated Tip



	Length	Catalog #	R0485
1 x 2 Teeth	7" (178mm)	R0485	
1 x 2 Teeth	8 1/4" (210mm)	R0486	
1 x 2 Teeth	9 1/2" (241mm)	R0487	

RUGGLES™ Potts–Smith Dressing Forceps



Length	Catalog #	R0480
7" (178mm)	R0480	
8 1/4" (210mm)	R0481	
9 1/2" (241mm)	R0482	

RUGGLES™ Potts–Smith Dressing Forceps with Tungsten–Carbide Inserts



Length	Catalog #	R0439
7 1/2" (191mm)	R0439	

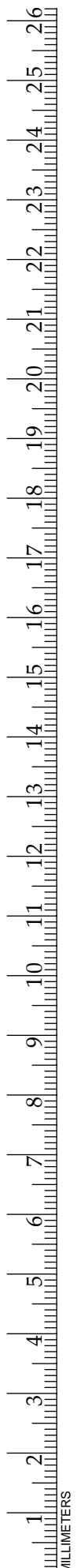

Forceps

RUGGLES™ Cushing Forceps

Serrated Handle



R0402

	Length	Catalog #
Serrated	7" (178mm)	R0400
1 x 2 Teeth	7" (178mm)	R0402
Brown Type Teeth	7" (178mm)	R0405
Serrated	8" (203mm)	R0434
1 x 2 Teeth	8" (203mm)	R0433
Carbide Insert	7 1/4" (184mm)	R0445
Carbide Insert, Angled	7 1/4" (184mm)	R0449
1 x 2 Teeth, Carbide	7" (178mm)	RT0172

RUGGLES™ Cushing Forceps

Gutsch Type Handle



R0410

	Length	Catalog #
Serrated	7" (178mm)	R0410
1 x 2 Teeth	7" (178mm)	R0412
Brown Type Teeth	7" (178mm)	R0413
1 x 2 Teeth, Serrated	7" (178mm)	RN0176

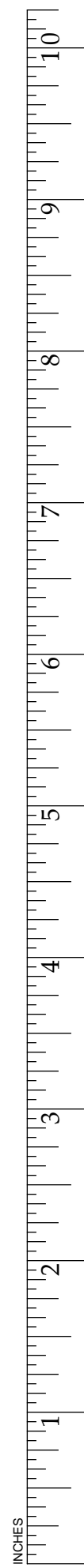

Forceps

RUGGLES™ Gerald Forceps



R0437

		Length	Catalog #
Tissue, 1 x 2 Teeth	Straight	7" (178mm)	R0435
Dressing	Straight	7" (178mm)	R0437
Tissue, 1 x 2 Teeth	Curved	7" (178mm)	R0440
Dressing	Curved	7" (178mm)	R0442

RUGGLES™ Gerald Forceps with Tungsten-Carbide Inserts

Tissue Forceps, Straight



RT0165

	Length	Catalog #
1 x 2 Teeth	7" (178mm)	RT0165

RUGGLES™ Semken Forceps



RN0141

	Length	Catalog #
Serrated	5" (127mm)	RN0144
1 x 2 Teeth	5" (127mm)	RN0141
2 x 3 Teeth	5" (127mm)	RN0143
Serrated	6" (152mm)	RN0145
1 x 2 Teeth	6" (152mm)	RN0142

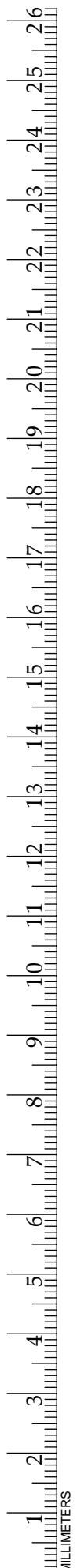

RUGGLES™ Thumb Forceps



R3004

Serrated		1 x 2 Teeth	
Length	Catalog #	Length	Catalog #
4 1/2" (114mm)	R3001	4 1/2" (114mm)	R3010
5" (127mm)	R3002	5" (127mm)	R3011
5 1/2" (140mm)	R3003	5 1/2" (140mm)	R3012
6 1/4" (159mm)	R3004	6 1/4" (159mm)	R3013
8" (203mm)	R3006	8" (203mm)	R3015
10" (254mm)	R3007	10" (254mm)	R3016
12" (305mm)	R3008	12" (305mm)	R3017

RUGGLES™ Dietrich Tissue Forceps



R0479

Tips	Length	Catalog #
1.5mm	6" (152mm)	R0478
1.5mm	7 3/4" (197mm)	R0479

RUGGLES™ Semken Forceps with Tungsten-Carbide Inserts

	Length	Catalog #
1 x 2 Teeth	6" (152mm)	RT0145
Serrated	6" (152mm)	RT0146



RT0145



Forceps

RUGGLES™ McCravey Tissue Forceps

Length	Catalog #
--------	-----------

7" (178mm)	R0455
------------	-------



R0455

RUGGLES™ Gilles Tissue Forceps

Length	Catalog #
--------	-----------

1 x 2 Teeth 6" (152mm)	R0431
------------------------	-------



R0431

RUGGLES™ McIndoe Tissue Forceps

Length	Catalog #
--------	-----------

6" (152mm)	R0432
------------	-------



R0432

RUGGLES™ Brain Forceps

Length	Catalog #
--------	-----------

Dressing 7" (178mm)	R0447
---------------------	-------

Tissue 7" (178mm)	R0448
-------------------	-------



R0448



Bayonet Forceps

RUGGLES™ Cushing Bayonet Forceps

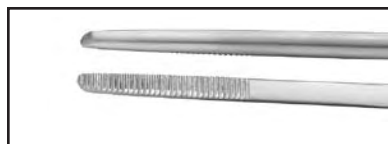

Serrated Teeth



1 x 2 Teeth

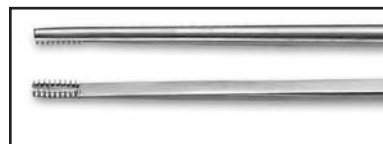

Brown Type Teeth



RN0171

	Length	Catalog #
Serrated	7 1/4" (184mm)	RN0171
1 x 2 Teeth	7 1/4" (184mm)	RN0173
1 x 2 Teeth, Carbide	7 1/4" (184mm)	RT0173
Brown Type Teeth	7 1/4" (184mm)	RN0178

RUGGLES™ Cushing Bayonet Forceps

Dissecting End



R0416

	Length	Catalog #
Dressing	7 3/4" (197mm)	R0416
Tissue	7 3/4" (197mm)	R0421

RUGGLES™ Gerald Bayonet Forceps



RN0162

	Length	Catalog #
Serrated	7 1/2" (191mm)	RN0162
1 x 2 Teeth	7 1/2" (191mm)	RN0163



Bayonet Forceps

RUGGLES™ Adson Bayonet Forceps



R0463

	Length	Catalog #
Delicate	7 1/4" (184mm)	R0462
Dressing	7 1/2" (191mm)	R0463

RUGGLES™ Hoen Bayonet Forceps



R0458

	Length	Catalog #
Tissue	7 3/4" (197mm)	R0458
Dressing	7 3/4" (197mm)	R0459

RUGGLES™ Jansen Bayonet Dressing Forceps



R0460

	Length	Catalog #
	6 1/2" (165mm)	R0460
	7 1/2" (191mm)	R0461

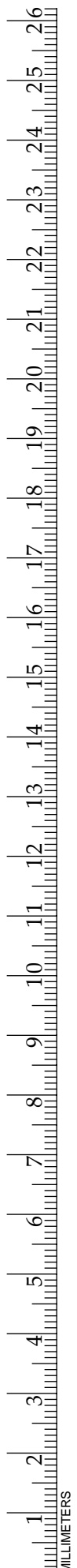

Bayonet Forceps

RUGGLES™ Jacobson Bayonet Forceps



Sharp



Blunt



Angled, Sharp



RN8138



RN8139



RN8141

Tips	Length	Catalog #
Sharp	6 1/4" (159mm)	RN8138
Blunt	7 1/4" (184mm)	RN8139
Sharp	7 1/4" (184mm)	RN8140
Angled, Sharp	7 1/4" (184mm)	RN8141

RUGGLES™ Gruenwald Bayonet Forceps

Length **Catalog #**

8" (203mm) **RN0168**



RN0168



Bayonet Forceps

RUGGLES™ Yasargil Bayonet Forceps



Blunt



RN8030

Tips	Length	Catalog #
Sharp	7 1/4" (184mm)	RN8032
Blunt	7 1/4" (184mm)	RN8033
Sharp	8 1/4" (210mm)	RN8030
Blunt	8 1/4" (210mm)	RN8031
Sharp	8 3/4" (222mm)	RN8029
Blunt	8 3/4" (222mm)	RN8028

RUGGLES™ Yasargil Bayonet Tumor Forceps



3mm Spoon Shaped Jaw



3mm Serrated, Flat Jaw



RN8034

Jaw	Length	Catalog #
3mm Spoon Shaped	8 1/2" (216mm)	RN8034
3mm Serrated, Flat	8 1/2" (216mm)	RN8036

RUGGLES™ Adson Hypophyseal Forceps



R0475

Tips	Length	Catalog #
Straight	9" (229mm)	R0475
Curved Up	9" (229mm)	R0476
Curved Down	9" (229mm)	R0477



Forceps

RUGGLES™ Ligamentum Flavum Forceps

Length Catalog #

7 1/4" (184mm) **R0507**



R0507

RUGGLES™ Hoen Alligator Forceps

Length Catalog #

1 x 2 Teeth 5 1/2" (140mm) **R0503**

Serrated 5 1/2" (140mm) **R0504**



R0504

RUGGLES™ Hartman Alligator Forceps

Length Catalog #

Serrated 8" (203mm) **R0506**



R0506

RUGGLES™ Dandy Scalp Hemostat

Length Catalog #

Curved Sideways 5 1/2" (140mm) **R0500**



R0500

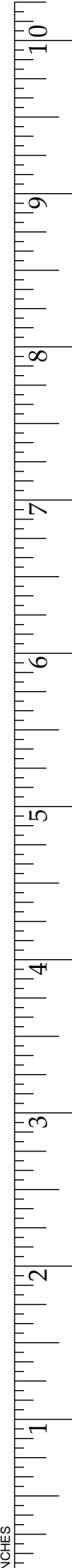

Forceps

RUGGLES™ Rochester-Pean Forceps



Straight



Curved



R3092

	Length	Catalog #
Straight	5 1/2" (140mm)	R3090
Straight	6 1/4" (159mm)	R3091
Straight	7 1/4" (184mm)	R3092
Straight	8" (203mm)	R3093
Straight	9" (229mm)	R3094
Curved	5 1/2" (140mm)	R3095
Curved	6 1/4" (159mm)	R3096
Curved	7 1/4" (184mm)	R3097
Curved	8" (203mm)	R3098
Curved	9" (229mm)	R3099



Needle Holder

RUGGLES™ Dura Closure Needle Holder

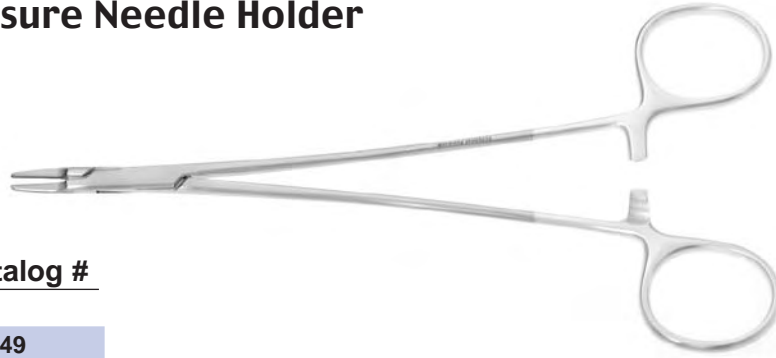

Tip	Length	Catalog #
-----	--------	-----------

1mm	7" (179mm)	R3549
-----	------------	-------

R3549

Ruler

RUGGLES™ Stainless Steel Ruler



Catalog #

RG2020

Metric & 32nd's	RG2020
-----------------	--------

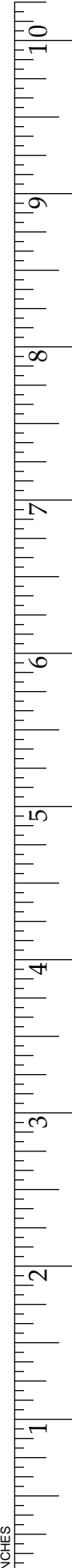

Tip Guards

RUGGLES™ Vinyl Tip Guards

Packages of 100



Catalog

White	R5501
Blue	R5502
Green	R5503
Red	R5504
Yellow	R5505
Maroon	R5506
Orange	R5507
Brown	R5508
Black	R5509



MICROSURGICAL INSTRUMENTATION



MICROSURGICAL INSTRUMENTATION

Microsurgical Dissection Instruments

RUGGLES™ Micro Dissection Set

Length Catalog #

7 1/2" (191mm) **RN6200**

Set includes one (1) each of items
RN6201 through RN6215 (see next page)
and one (1) Instrument Tray RN6220

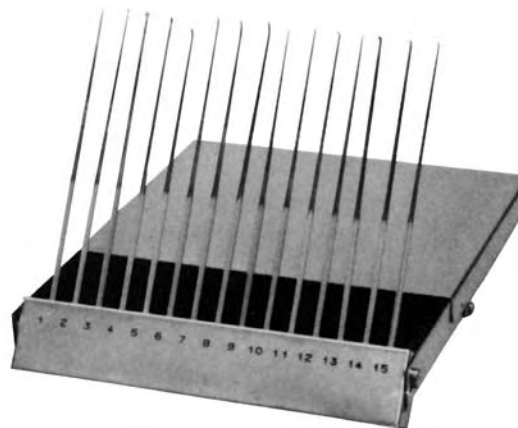

RN6200

RUGGLES™ Expanded Micro Dissection Set

Length Catalog #

7 1/2" (191mm) **RN6230**

Set includes one (1) each of items
RN6201 through RN6219 (see next page)
and one (1) Instrument Tray RS6219



RN6230

RUGGLES™ Micro Ball Dissector Set (not shown)

Length Catalog #

7 1/2" (191mm) **RN6225**

Set includes one (1) each of items
RN6215 through RN6219 (see next page)
and one (1) Instrument Tray RS6215

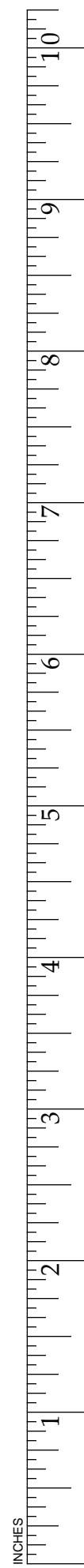

Microsurgical Dissection Instruments

Dissection set catalog numbers are listed on previous page

RUGGLES™ Micro Dissection Set Components, Length 7 1/2" (191mm)



Round Dissector

1mm RN6201



Round Dissector

2mm RN6202



Round Dissector

3mm RN6203



Elevator

Curved RN6204



Elevator

Angled RN6205



Spatula Dissector

Small RN6206
Width 1.25mm



Spatula Dissector

Medium RN6207
Width 1.65mm



Spatula Dissector

Large RN6208
Width 2.18mm



Right Angle Hook

Semi-Sharp RN6209



Right Angle Hook

Blunt RN6210



Needle Dissector

Semi-Sharp RN6211
45° Angle



Needle Dissector

Semi-Sharp RN6212
Straight



Micro Curette

1x2 mm Cup RN6213
Straight



Micro Curette

1x2 mm Cup RN6214
Angled



Ball Dissector

3mm RN6215
90° Angle



Ball Dissector

5mm RN6216
90° Angle



Ball Dissector

4mm RN6217
45° Angle



Ball Dissector

8mm RN6218
45° Angle



Ball Dissector

Straight RN6219



Microsurgical Dissection Instruments

RUGGLES™ Apfelbaum Dissector Set, Straight, Length 8 3/4" (222mm)



Length **Catalog #**

8 3/4" (222mm) **RN6700**

Set includes one (1) each of items RN6701 through RN6717 and one (1) Instrument Tray RS6700

Apfelbaum Dissection Tray

RS6700



Round Dissector

1mm **RN6701**
Sharp Edges



Round Dissector

2mm **RN6702**
Sharp Edges



Round Dissector

3mm **RN6703**
Sharp Edges



Elevator

Wide **RN6704**



Elevator

Narrow **RN6705**



Spatula Dissector

Curved **RN6706**



Spatula Dissector

Angled **RN6707**



Spatula Dissector

90° **RN6708**



Right Angle Hook

45° **RN6709**



Teardrop Dissector

90° **RN6710**



Teardrop Dissector

45° **RN6711**



Dura Knife

Large **RN6712**



Dura Knife

Small **RN6713**



Curette

1mm **RN6714**
Angled



Curette

2mm **RN6715**
Angled



Curette

1mm **RN6716**
Double Angle



Curette

2mm **RN6717**
Double Angle



Microsurgical Dissection Instruments

RUGGLES™ Apfelbaum Dissector Set, Angled, Length 8 3/4" (222mm)



Length **Catalog #**

8 3/4" (222mm) **RN6600**

Set includes one (1) each of items RN6601 through RN6617 and one (1) Instrument Tray RS6600

Apfelbaum Dissection Tray

RS6600



Round Dissector

1mm **RN6601**
Sharp Edges



Round Dissector

2mm **RN6602**
Sharp Edges



Round Dissector

3mm **RN6603**
Sharp Edges



Elevator

Wide **RN6604**



Elevator

Narrow **RN6605**



Spatula Dissector

Curved **RN6606**



Spatula Dissector

Angled **RN6607**



Spatula Dissector

90° **RN6608**



Right Angle Hook

45° **RN6609**

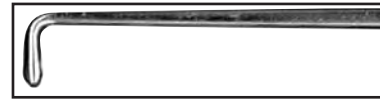

Teardrop Dissector

90° **RN6610**



Teardrop Dissector

45° **RN6611**



Dura Knife

Large **RN6612**

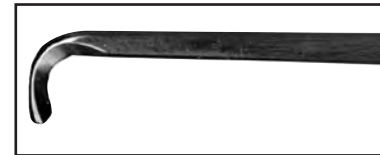

Dura Knife

Small **RN6613**



Curette

1mm **RN6614**
Angled

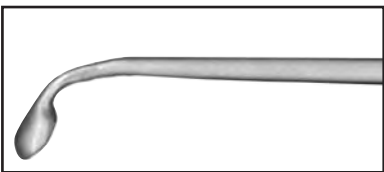

Curette

2mm **RN6615**
Angled



Curette

1mm **RN6616**
Double Angle



Curette

2mm **RN6617**
Double Angle



Microsurgical Dissection Instruments

RUGGLES™ Apfelbaum Micro Dissection Mirror



RN6626

Length	Catalog #
6mm 9" (229mm)	RN6626

RUGGLES™ Micro Dissection Set, Straight, Length 7 1/4" (184mm)



R8410



Ligature Guide

Slight Curve R8401



Ligature Guide

Strong Curve R8402



Ligature Guide

Angled R8403



Jacobson Vessel Knife

R8408



Raspatory

Angled R8409



Dissector

R8410



Raspatory

Large R8411



Raspatory

Small R8412

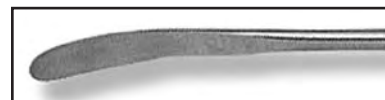

Raspatory

Strong Curve R8413

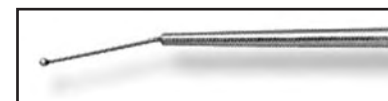

Jacobson Probe

Angled R8414



Jacobson Probe

Straight R8415



Jacobson Suture Pusher

R8416



Microsurgical Dissection Instruments

RUGGLES™ F-G Series Fukushima–Giannotta Skullbase and Micro Dissectors, Length 7 1/4" (184mm)



R8935

Sterilization Case

R8977



Dissector

3mm R8935
Slightly Curved

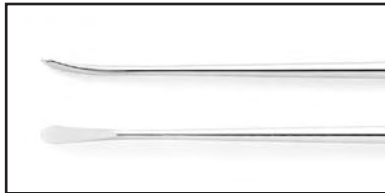

Dissector

2mm R8938
Slightly Curved



Hook

2.5mm R8941
90° Straight



Knife

3mm R8944
45° Sharp Tip

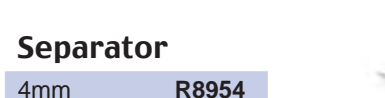

Separator

4mm R8954
Straight Slight Curve

Separator

4mm R8955
Straight 90°

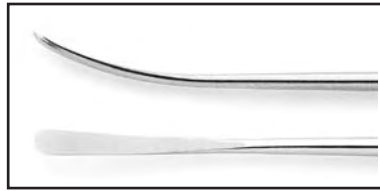

Dissector

3mm R8936
Very Curved



Dissector

1.8mm R8939
Very Curved



Knife

3mm R8942
90° Sharp Tip



Probe

Straight R8945
Bullet Tip

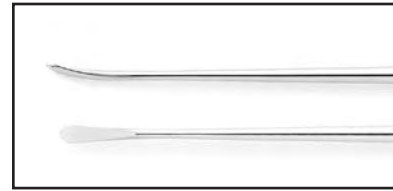

Dissector

2.5mm R8937
Duckbill Curved

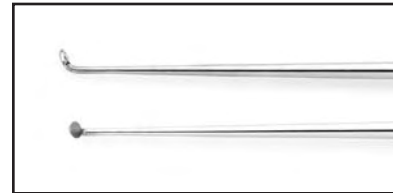

Knife

2mm R8940
Round Angle



Knife

4mm R8943
90° Blunt Tip



R8954



R8955

continued on next page



Microsurgical Dissection Instruments

continued from previous page

RUGGLES™ F-G Series Fukushima-Giannotta Skullbase and Micro Dissectors, Length 7 1/4" (184mm)

Sterilization Case

R8977



R-8946



Bayonet Probe

Straight R8946
Bullet Tip



Bayonet Probe

3mm R8947
30° Bullet Tip



Bayonet Probe

3mm R8948
60° Bullet Tip



Bayonet Probe

3mm R8949
90° Bullet Tip



Ring Curette

2.5mm R8950
45° Up, Sharp



Ring Curette

3mm R8951
45° Up, Sharp



Ring Curette

4mm R8952
45° Up, Sharp



Cup Curette

2 x 3mm R8953
20° Up

8cm Dissector

3mm R8956
Touch Spring
for Electrocautery



R8956

Periosteal Elevator

Flat R8957
1/2" Blade



R8957

11cm Probe, Insulated

Touch Spring R8958
for Electrocautery



R8958



Microsurgical Dissection Instruments

RUGGLES™ Fukushima–Chen Cerebellar Pontine Tumor Bayonet Micro Dissectors, Length 7 1/2" (191mm)



Knife

Very Sharp
Blunt Tip **R8876**



R8876

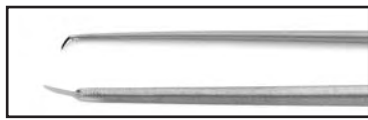

Knife

45° Up, 2.5mm **R8877**
Semi-Blunt

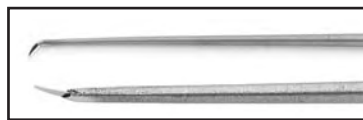

Knife

45° Up, 3mm **R8878**
Sharp



Knife

80° Up, 2.5mm **R8879**
Sharp Tip and Edge

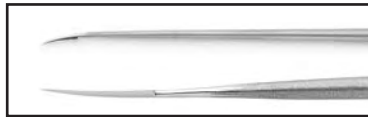

Knife

Sickle Style **R8881**
Very Thin, Sharp

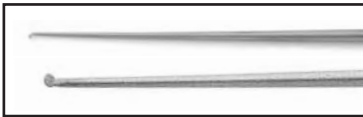

Round Knife

Angled, 1mm **R8887**
Very Sharp

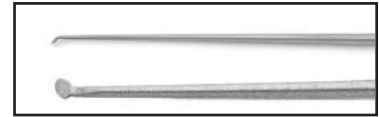

Round Knife

Angled, 1.5mm **R8888**
Very Sharp

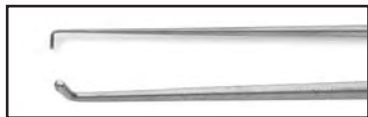

Probe

90° Up, 3mm **R8880**
Bullet Tip

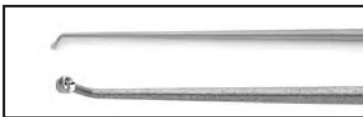

Ring Curette

60° Up **R8882**
1.2mm



Ring Curette

45° Up **R8883**
1.5mm

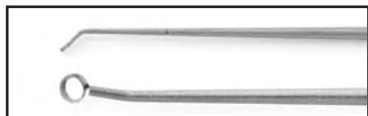

Ring Curette

45° Up **R8884**
2mm

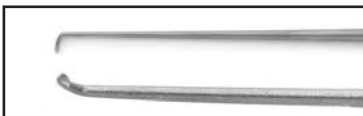

Cup Curette

75° Up **R8885**
1 x 1.5mm

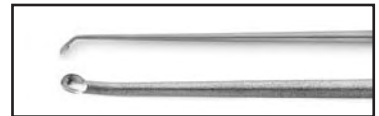

Cup Curette

45° Up **R8886**
1.5 x 2mm



Dissector

1mm **R8889**
Slightly Curved



Dissector

2mm **R8890**
Slightly Curved

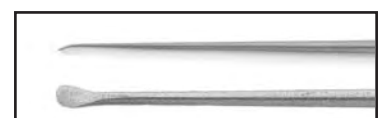

Dissector

1.5mm, 30° **R8891**
Duckbill Curved



Microsurgical Dissection Instruments

RUGGLES™ John Day Periosteal Elevator

Cup	Catalog #
6mm	R8906
6mm	R8907
6mm	R8908
12mm	R8909



RUGGLES™ T. Fukushima Dural Elevator and Spatula



	Catalog #
Double Ended	R8911
Double Ended, Reduced	R8912



Microsurgical Dissection Instruments

RUGGLES™ Round Handled Instruments, Length 7 1/2" (191mm) Rhoton Style



R7330

Dissector

1mm R7330

2mm R7331

3mm R7332



Elevator

2.8mm R7333



Elevator

1.2mm R7334



Spatula

1mm R7335

1.5mm R7336

2mm R7337



Hook

90°, 2mm R7338
Semi-Sharp



Hook

90°, 2mm R7339
Blunt



Probe

90°, 2mm R7340
Ball Tip



Hook

45°, 3mm R7341
Semi-Sharp



Needle

Semi-Sharp R7342



Oval Curette

1 x 2mm, Straight R7343

1 x 2mm, Angled R7344

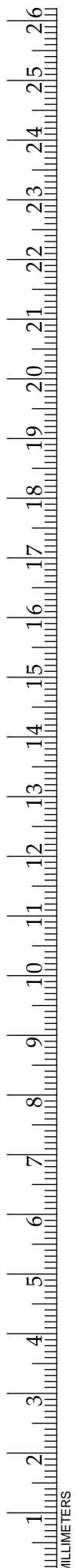

RUGGLES™ Titanium Probe, Length 7 1/4" (184mm)



Ligature Passer

651301

3mm Hook 651301



Nerve Hook

3mm Hook with Ball 651302



Nerve Hook

2mm Hook 651303



Nerve Hook

3mm Hook 651304



Vessel Supporter

2mm Hook 651305



Dissector

Angled 651306
Curved Edge
Semi-Sharp (3.5mm)



Bayonet Curette

2mm Cup 651307



Elevator

Curved 3.5mm 651308

Bayonet 3.5mm 651309



Dissector

Angled 651310
Sharp on 3 Sides (1.2mm)



Round Dissector

1.0mm 651311

2.0mm 651312

3.5mm 651313



Biopsy Needles

RUGGLES™ Titanium Biopsy Needle



651601

Catalog #	651600
-----------	--------

Window	3/8" (10mm)
Cannula Outer Length	7 7/8" (200mm)
Cannula Inner Length	8 5/8" (219mm)
Overall Cannula Length	9 3/4" (248mm)
Outer Diameter	1/8" (2.5mm)
Inner Diameter	1/16" (2.0mm)

Catalog #	651601
-----------	--------

Window	3/16" (5mm)
Cannula Outer Length	7 7/8" (200mm)
Cannula Inner Length	8 5/8" (219mm)
Overall Cannula Length	9 3/4" (248mm)
Outer Diameter	1/8" (2.5mm)
Inner Diameter	1/16" (2.0mm)

Catalog #	651605
-----------	--------

Window	3/8" (10mm)
Cannula Outer Length	3 9/16" (90mm)
Cannula Inner Length	4 5/16" (109mm)
Overall Cannula Length	5 7/16" (138mm)
Outer Diameter	1/8" (2.5mm)
Inner Diameter	1/16" (2.0mm)



RUGGLES™ Titanium Straight Diamond Knife

Long Handle, Retractable Blade



651-200

Blade	Length*	Catalog #
-------	---------	-----------

45° Straight	8 7/16" (215mm)	651200
--------------	-----------------	--------

RUGGLES™ Titanium Straight Diamond Knife

Long Handle, Retractable Blade



651-210

Blade	Length*	Catalog #
-------	---------	-----------

Lance Blade	8 11/16" (220mm)	651210
-------------	------------------	--------

RUGGLES™ Titanium Bayonet Diamond Knife

Short Handle



651-214

Blade	Length*	Catalog #
-------	---------	-----------

45° Straight	8 11/16" (220mm)	651214
--------------	------------------	--------

* Length is with blade exposed



Microsurgical Hooks

RUGGLES™ Krayenbuhl Hook



RN8128



RN8126

without Finger Rest

		Length	Catalog #
Dura Hook	Curved	7 1/4" (184mm)	RN8125
Dura Hook	90° Angle	7 1/4" (184mm)	RN8126
Twist Hook	1mm Diameter	7 1/4" (184mm)	RN8127
Twist Hook	1.8mm Diameter	7 1/4" (184mm)	RN8128

with Finger Rest

		Length	Catalog #
Blunt Hook	Small	7 1/4" (184mm)	RN8121
Blunt Hook	Large	7 1/4" (184mm)	RN8122
Ball Tip	Small	7 1/4" (184mm)	RN8123
Ball Tip	Large	7 1/4" (184mm)	RN8124

RUGGLES™ Adson Dissecting Hook



R0855

	Length	Catalog #
5mm Hook	9" (229mm)	R0845
Sharp	8" (203mm)	R0855
Blunt	8" (203mm)	R0856

RUGGLES™ Weary Nerve Hook



RN0127

	Length	Catalog #
Black	7 3/4" (197mm)	RN0127



Microsurgical Hooks

RUGGLES™ Dura Hook



	Length	Catalog #	
			R8234
Regular	7 1/4" (184mm)	R8234	
Delicate	7 1/4" (184mm)	R8235	

RUGGLES™ Murphy Ball Hook



Ball	Length	Catalog #	
			R0848
2mm	8" (203mm)	R0848	

RUGGLES™ Microsurgical Bayonet Handle Hook

Length 9 1/2" (240mm)

Nerve Hook



		Catalog #	
			R7305
3mm	90°	R7305	
4mm	90°	R7306	
5mm	90°	R7307	R7308
5mm	Curved Up	R7308	
8mm	Curved Up	R7309	
3mm	Ball Point	R7310	R7310

Micro Hook



		Catalog #	
			R7318
2mm	Blunt	R7315	
2.5mm	Blunt	R7316	
3mm	Blunt	R7317	
2mm	Semi-Sharp	R7318	

Ligature Needle



	Catalog #	
3mm	R7320	
5mm	R7321	R7321



Microsurgical Instruments

RUGGLES™ Yasargil Ligature Carrier, Length 7 1/4" (184mm)



RN8112

Catalog

Probe Point	90°	Angle	RN8111
Probe Point	3/4" (19mm)	Curved	RN8112
Probe Point	5/8" (16mm)	Curved, Short	RN8113
Probe Point	1/2" (13mm)	Curved, Long	RN8114

RUGGLES™ Micro Tissue Lifter



R8515

Length Catalog

1mm	Small	7 1/4" (184mm)	R8510
2mm	Large	7 1/4" (184mm)	R8515

RUGGLES™ Micro Arachnoidea Knife



R8445

Length Catalog

Curved Down		7 1/4" (184mm)	R8445
-------------	--	----------------	-------

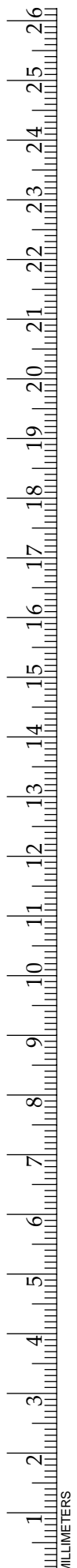

Microsurgical Forceps

RUGGLES™ Micro Forceps



Length Catalog #

RN8294

Round Handle 1 x 2 Teeth, 7 1/4" (184mm) Delicate **RN8294**

RUGGLES™ Micro Tying Forceps

Counterbalanced, Tungsten Carbide Dust



Length Catalog #

RN8295

Round Handle, Curved 8 1/4" (210mm) **RN8295**

RUGGLES™ Micro Ring Forceps

Counterbalanced



Length Catalog #

RN0188

Round Handle 8 1/4" (210mm) **RN0188**

Round Handle 9" (229mm) **RN0189**

RUGGLES™ Micro Forceps with Catch



Length Catalog #

R8230

Strongly Curved Jaws 7 1/4" (184mm) **R8230**

Slightly Curved Jaws 7 1/4" (184mm) **R8231**

RUGGLES™ Micro Forceps

Flat, Bayonet Handle



Tips Length Catalog #

R8251

Straight Normal 9" (229mm) **R8250**

Straight Extra Fine 9" (229mm) **R8251**



Microsurgical Bipolar Forceps

RUGGLES™ Iris Bipolar Straight Forceps

Tips	Length	Catalog #
------	--------	-----------

Straight	3 1/2" (90mm)	R2645
----------	---------------	-------

Curved	3 1/2" (90mm)	R2646
--------	---------------	-------



R2646

RUGGLES™ Semken Bipolar Straight Forceps

Tips	Length	Catalog #
------	--------	-----------

Straight	5 1/4" (135mm)	R2640
----------	----------------	-------



R2640

RUGGLES™ Microsurgical Bipolar Bayonet Forceps

Tips	Length	Catalog #
------	--------	-----------

Flat Handle	40° Down	7 1/4" (184mm)	R2620
-------------	----------	----------------	-------

Flat Handle	Straight	7 1/8" (181mm)	R2696
-------------	----------	----------------	-------



R2696

RUGGLES™ Transphenoidal Hypophysectomy Bipolar Bayonet Forceps

Length	Catalog #
--------	-----------

Flat Handle, Straight	8 1/2" (216mm)	R2697
-----------------------	----------------	-------

Flat Handle, Straight, Insulated	8 1/2" (216mm)	R2698
----------------------------------	----------------	-------



R2698

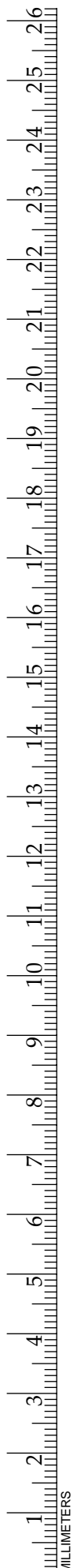

Microsurgical Bipolar Forceps

Hardy Style Bipolar Bayonet Forceps

Irrigated, Insulated

Straight Tips

Tips	Length	Catalog #
0.2mm	8 1/2" (216mm)	RR2201
0.4mm	8 1/2" (216mm)	RR2202
0.5mm	8 1/2" (216mm)	RR2203
0.7mm	8 1/2" (216mm)	RR2204
1.0mm	8 1/2" (216mm)	RR2205
1.3mm	8 1/2" (216mm)	RR2206
1.5mm	8 1/2" (216mm)	RR2207
1.7mm	8 1/2" (216mm)	RR2208
2.0mm	8 1/2" (216mm)	RR2209



RR2204

45° Angle Down

Tips	Length	Catalog #
0.2mm	8 1/2" (216mm)	RR2301
0.4mm	8 1/2" (216mm)	RR2302
0.5mm	8 1/2" (216mm)	RR2303
0.7mm	8 1/2" (216mm)	RR2304
1.0mm	8 1/2" (216mm)	RR2305
1.3mm	8 1/2" (216mm)	RR2306
1.5mm	8 1/2" (216mm)	RR2307
1.7mm	8 1/2" (216mm)	RR2308
2.0mm	8 1/2" (216mm)	RR2309



RR2304

45° Angle Up

Tips	Length	Catalog #
0.2mm	8 1/2" (216mm)	RR2401
0.4mm	8 1/2" (216mm)	RR2402
0.5mm	8 1/2" (216mm)	RR2403
0.7mm	8 1/2" (216mm)	RR2404
1.0mm	8 1/2" (216mm)	RR2405
1.3mm	8 1/2" (216mm)	RR2406
1.5mm	8 1/2" (216mm)	RR2407
1.7mm	8 1/2" (216mm)	RR2408
2.0mm	8 1/2" (216mm)	RR2409



RR2404



Microsurgical Bipolar Forceps

Hardy Style Bipolar Bayonet Forceps

Insulated

Straight Tips

Tips	Length	Catalog #
0.2mm	8 1/2" (216mm)	RR2501
0.4mm	8 1/2" (216mm)	RR2502
0.5mm	8 1/2" (216mm)	RR2503
0.7mm	8 1/2" (216mm)	RR2504
1.0mm	8 1/2" (216mm)	RR2505
1.3mm	8 1/2" (216mm)	RR2506
1.5mm	8 1/2" (216mm)	RR2507
1.7mm	8 1/2" (216mm)	RR2508
2.0mm	8 1/2" (216mm)	RR2509



RR2505

Scoville–Green Style Bipolar Bayonet Forceps

Insulated

Straight Tips

Tips	Length	Catalog #
0.2mm	7 3/4" (197mm)	RR2601
0.4mm	7 3/4" (197mm)	RR2602
0.5mm	7 3/4" (197mm)	RR2603
0.7mm	7 3/4" (197mm)	RR2604
1.0mm	7 3/4" (197mm)	RR2605
1.3mm	7 3/4" (197mm)	RR2606
1.5mm	7 3/4" (197mm)	RR2607
1.7mm	7 3/4" (197mm)	RR2608
2.0mm	7 3/4" (197mm)	RR2609



RR2605



Yasargil Style Bipolar Bayonet Forceps Irrigated

Straight Tips

Tips	Length	Catalog #
------	--------	-----------

0.5mm	6 1/4" (159mm)	RR2701
-------	----------------	--------

0.7mm	6 1/4" (159mm)	RR2702
-------	----------------	--------

1.0mm	6 1/4" (159mm)	RR2703
-------	----------------	--------

1.3mm	6 1/4" (159mm)	RR2704
-------	----------------	--------

Tips	Length	Catalog #
------	--------	-----------

0.5mm	7 1/8" (181mm)	RR2705
-------	----------------	--------

0.7mm	7 1/8" (181mm)	RR2706
-------	----------------	--------

1.0mm	7 1/8" (181mm)	RR2707
-------	----------------	--------

1.3mm	7 1/8" (181mm)	RR2708
-------	----------------	--------

Tips	Length	Catalog #
------	--------	-----------

0.5mm	7 7/8" (200mm)	RR2709
-------	----------------	--------

0.7mm	7 7/8" (200mm)	RR2710
-------	----------------	--------

1.0mm	7 7/8" (200mm)	RR2711
-------	----------------	--------

1.3mm	7 7/8" (200mm)	RR2712
-------	----------------	--------



RR2711



Titanium Microsurgical Bipolar Forceps

Titanium Bipolar Bayonet Forceps

Irrigated, Insulated

Straight Tips

Tips	Length	Catalog #
0.2mm	8 3/4" (222mm)	RR2804
0.4mm	8 3/4" (222mm)	RR2805
0.5mm	8 3/4" (222mm)	RR2806
0.7mm	8 3/4" (222mm)	RR2807
1.0mm	8 3/4" (222mm)	RR2808
1.3mm	8 3/4" (222mm)	RR2809
1.5mm	8 3/4" (222mm)	RR2810
1.7mm	8 3/4" (222mm)	RR2811
2.0mm	8 3/4" (222mm)	RR2812



RR2810

RUGGLES™ Titanium Bipolar Bayonet Forceps



R-2693

Tips	Length	Catalog #
Straight/Regular (1.5mm)	8 3/4" (222mm)	R2691
Straight/Fine (0.5mm)	8 3/4" (222mm)	R2692
Straight/Medium (1.0mm)	8 3/4" (222mm)	R2693
Angled Up/Fine (0.5mm)	8 3/4" (222mm)	R2694



Titanium Microsurgical Bipolar Forceps

RUGGLES™ Apfelbaum Bipolar Bayonet Forceps



Straight



Up



Down

Apfelbaum Bipolar Forceps Set

Catalog

RN1120

Set includes one (1) each of items RN1121 through RN1129N and one (1) Instrument Tray RS1120

Apfelbaum Bipolar Forceps Tray

RS1120

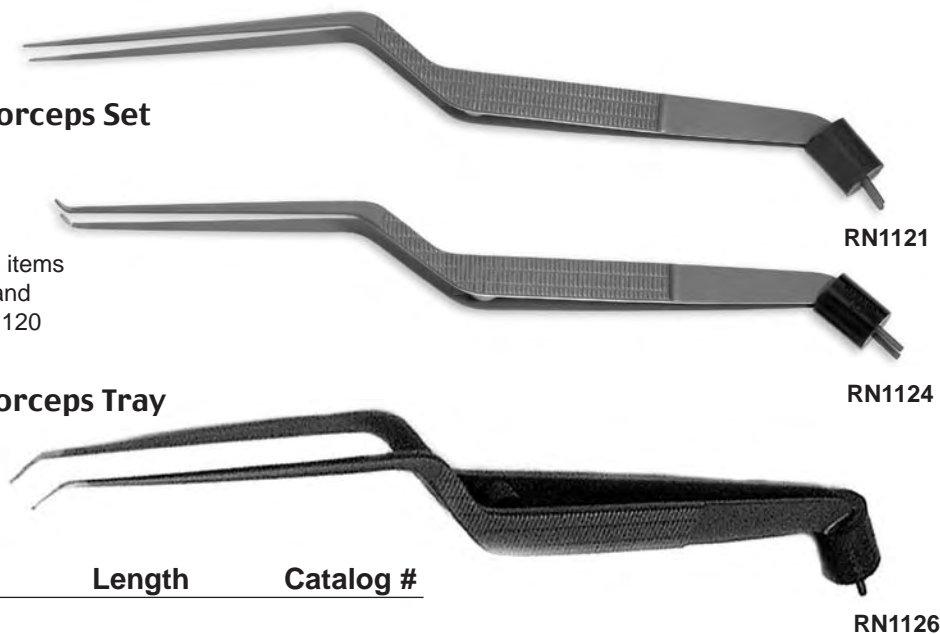

	Tips	Length	Catalog #
Titanium	Straight (0.7mm)	8 3/4" (222mm)	RN1121
Titanium	Straight (1.0mm)	8 3/4" (222mm)	RN1122
Titanium	Angled Up (0.7mm)	8 3/4" (222mm)	RN1123
Titanium	Angled Up (1.0mm)	8 3/4" (222mm)	RN1124
Titanium	Angled Down (0.7mm)	8 3/4" (222mm)	RN1125
Titanium	Angled Down (1.0mm)	8 3/4" (222mm)	RN1126

	Tips	Length	Catalog #
Titanium	Straight (0.7mm)	10" (254mm)	RN1127
Titanium	Angled Up (0.7mm)	10" (254mm)	RN1128
Titanium	Angled Down (0.7mm)	10" (254mm)	RN1129

	Tips	Length	Catalog #
Insulated	Straight (0.7mm)	10" (254mm)	RN1127N
Insulated	Angled Up (0.7mm)	10" (254mm)	RN1128N
Insulated	Angled Down (0.7mm)	10" (254mm)	RN1129N



Microsurgical Scissors

RUGGLES™ Micro Scissors



RN8060

	Blades	Length	Catalog #
Round Handle	Straight	7" (178mm)	RN6240
Round Handle	Curved	7" (178mm)	RN6241
Round Handle	Straight, Long	7" (178mm)	RN8060
Round Handle	Curved, Long	7" (178mm)	RN8061

RUGGLES™ Micro Scissors



R8312

		Length	Catalog #
Round Handle	60° Angled Blades	7" (178mm)	R8312

RUGGLES™ Jacobson Scissors



RN8142

	Blades	Length	Catalog #
Flat Handle	Straight	7 1/4" (184mm)	RN8142
Flat Handle	Curved	7 1/4" (184mm)	RN8143
Flat Handle	Angled	7 1/4" (184mm)	RN8144



Microsurgical Scissors

RUGGLES™ Micro Bayonet Scissors



RN6254

	Blades	Length	Catalog #
Round Handle	Straight	8 3/4" (222mm)	RN6253
Round Handle	Curved	8 3/4" (222mm)	RN6254
Round Handle	Straight	9 1/2" (241mm)	RN6255
Round Handle	Curved	9 1/2" (241mm)	RN6256
Round Handle	Straight	8 1/4" (210mm)	RN8065
Round Handle	Curved	8 1/4" (210mm)	RN8066

RUGGLES™ Jacobson Micro Bayonet Scissors



RN8148

	Blades	Length	Catalog #
Flat Handle	Straight	7 1/4" (184mm)	RN8145
Flat Handle	Curved	7 1/4" (184mm)	RN8146
Flat Handle	Angled	7 1/4" (184mm)	RN8147
Flat Handle	Micro Straight	7 1/4" (184mm)	RN8148
Flat Handle	Micro Curved	7 1/4" (184mm)	RN8149

RUGGLES™ Yasargil Micro Bayonet Scissors



RN8020

	Blades	Length	Catalog #
Flat Handle	Straight	8 3/4" (222mm)	RN8020
Flat Handle	Curved	8 3/4" (222mm)	RN8021
Flat Handle	Micro Straight	8 3/4" (222mm)	RN8022
Flat Handle	Micro Curved	8 3/4" (222mm)	RN8023



Microsurgical Serrated Scissors

RUGGLES™ Micro Serrated Bayonet Scissors



Straight



Up



Down

Micro Serrated Bayonet Scissors Tray

RS8000



The serrations firmly hold tissue in place for easy cutting. The scissor blades stay sharp longer.

RN8000 Sharp Micro Scissors Set

Set includes one (1) each of items RN8001 through RN8009 and one (1) Instrument Tray RS8000

	Length	Catalog #
Straight	9 1/4" (234mm)	RN8001
Up	9 1/4" (234mm)	RN8002
Down	9 1/4" (234mm)	RN8003
Straight	10 1/2" (267mm)	RN8004
Up	10 1/2" (267mm)	RN8005
Straight	8 1/4" (210mm)	RN8006
Up	8 1/4" (210mm)	RN8007
Straight	7 1/4" (184mm)	RN8008
Up	7 1/4" (184mm)	RN8009

RN8000B Blunt Micro Scissors Set

Set includes one (1) each of items RN8001B through RN8009B and one (1) Instrument Tray RS8000

	Length	Catalog #
Straight	9 1/4" (234mm)	RN8001B
Up	9 1/4" (234mm)	RN8002B
Down	9 1/4" (234mm)	RN8003B
Straight	10 1/2" (267mm)	RN8004B
Up	10 1/2" (267mm)	RN8005B
Straight	8 1/4" (210mm)	RN8006B
Up	8 1/4" (210mm)	RN8007B
Straight	7 1/4" (184mm)	RN8008B
Up	7 1/4" (184mm)	RN8009B



RUGGLES™ Fukushima–Giannotta Micro Bayonet Scissors



R8924

Micro Scissors

8 1/16" (205mm) **R8924**
Straight, Long, Blunt



Micro Scissors

7 5/16" (185mm) **R8925**
Straight



Micro Scissors

7 5/16" (185mm) **R8926**
Curved Up



Micro Scissors

8 1/16" (205mm) **R8927**
Straight



Micro Scissors

8 1/16" (205mm) **R8928**
Curved Up



Micro Scissors

8 11/16" (220mm) **R8929**
Straight



Micro Scissors

8 11/16" (220mm) **R8930**
Curved Up

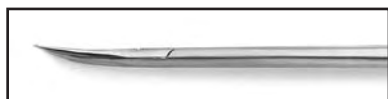

Micro Scissors

8" (203mm) **R8931**
Curved Up, Very Fine



Micro Scissors

7 5/16" (185mm) **R8931S**
Curved Up, Very Fine



Micro Scissors

9 7/16" (240mm) **R8932**
Curved Up

RUGGLES™ Fukushima–Giannotta Micro Bayonet Needle Holder



Micro Needle Holders

7 7/8" (200mm) **R8933**
Straight

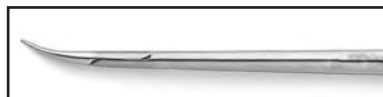

Micro Needle Holders

7 7/8" (200mm) **R8934**
Curved Up



Titanium Microsurgical Scissors

RUGGLES™ Titanium Straight Scissors

Blades **Length** **Catalog #**

Standard 6 5/8" (168mm) **651365**

Curved 6 5/8" (168mm) **651366**



651365

RUGGLES™ Titanium Round Handled Straight Scissors

Blades **Length** **Catalog #**

Standard 7 1/8" (181mm) **651375**

Curved 7 1/8" (181mm) **651376**



651376

RUGGLES™ Titanium Bayonet Scissors

Blades **Length** **Catalog #**

Straight/Regular 8 5/8" (219mm) **651367**

Straight/Fine 8 5/8" (219mm) **651370**

Curved Up/ Regular 8 5/8" (219mm) **651368**

Curved Up/Fine 8 5/8" (219mm) **651371**

Curved Down/Regular 8 5/8" (219mm) **651369**



651367

RUGGLES™ Titanium Round Handled Bayonet Scissors

Blades **Length** **Catalog #**

Standard 8 5/8" (219mm) **651377**

Curved 8 5/8" (219mm) **651378**



651377

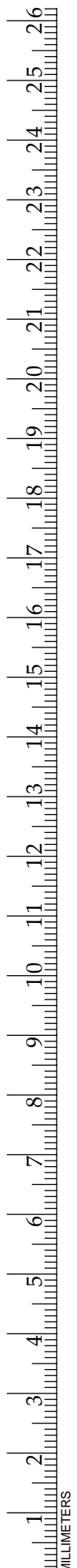

Microsurgical Needle Holders

RUGGLES™ Jacobson Micro Needle Holder

Straight Jaws



RN8297

		Length	Catalog #
Round Handle	with Lock	7" (178mm)	RN8297
Round Handle	with Lock	8 1/4" (210mm)	RN8298
Round Handle	with Lock	9" (229mm)	RN8299
Flat Handle	with Lock	7" (178mm)	RN8275
Flat Handle	without Lock	7" (178mm)	RN8276

RUGGLES™ Jacobson Micro Needle Holder

Straight Jaws



R8220

		Length	Catalog #
Flat Handle	with Lock	7 1/4" (184mm)	R8220

RUGGLES™ Jacobson Micro Bayonet Needle Holder



RN8137

	Jaws	Length	Catalog #
Flat Handle	Straight	7 1/4" (184mm)	RN8136
Flat Handle	Curved	7 1/4" (184mm)	RN8137

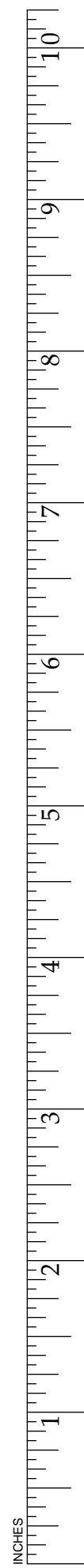

Microsurgical Needle Holders

RUGGLES™ Micro Bayonet Needle Holder



R-8256

	Jaws	Length	Catalog #
Flat Handle	Straight	9" (229mm)	R8256
Flat Handle	Curved, Fine	9" (229mm)	R8257

RUGGLES™ Micro Needle Holder Slightly Curved Jaws



R8210

		Length	Catalog #
Flat Handle	with Lock	7 1/4" (184mm)	R8210

RUGGLES™ Micro Bayonet Needle Holder



RN6271

	Jaws	Length	Catalog #
Round Handle	Straight	8 1/2" (216mm)	RN6271
Round Handle	Curved	8 1/2" (216mm)	RN6272
Round Handle	Straight	9 1/4" (235mm)	RN6273
Round Handle	Curved	9 1/4" (235mm)	RN6274

RUGGLES™ Yasargil Micro Bayonet Needle Holder



RN8026

	Jaws	Length	Catalog #
Flat Handle	Straight	9" (229mm)	RN8025
Flat Handle	Curved	9" (229mm)	RN8026

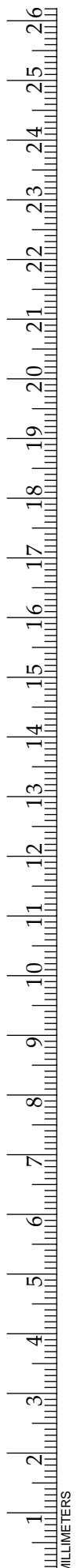

Titanium Microsurgical Needle Holders

RUGGLES™ Titanium Bayonet Needle Holder with Lock



Tips	Length	Catalog #
Straight (1.0mm)	8 5/8" (219mm)	651388
Straight (0.5mm)	8 5/8" (219mm)	651389
Curved (1.0mm)	8 5/8" (219mm)	651390

651388

RUGGLES™ Titanium Round Handled Bayonet Needle Holder



Tips	Length	Catalog #
Straight (1.0mm)	8 5/8" (219mm)	651394
Curved (1.0mm)	8 5/8" (219mm)	651395

651394



Microsurgical Ring Handled Forceps and Scissors

RUGGLES™ Ring Handled Microsurgical Forceps

Cup		Length	Catalog #
0.5mm	Straight	5 1/2" (140mm)	R8850
0.5mm	Angled Right	5 1/2" (140mm)	R8851
0.5mm	Angled Left	5 1/2" (140mm)	R8852
1mm	Straight	5 1/2" (140mm)	R8855
1mm	Angled Right	5 1/2" (140mm)	R8856
1mm	Angled Left	5 1/2" (140mm)	R8857
2mm	Straight	5 1/2" (140mm)	R8858

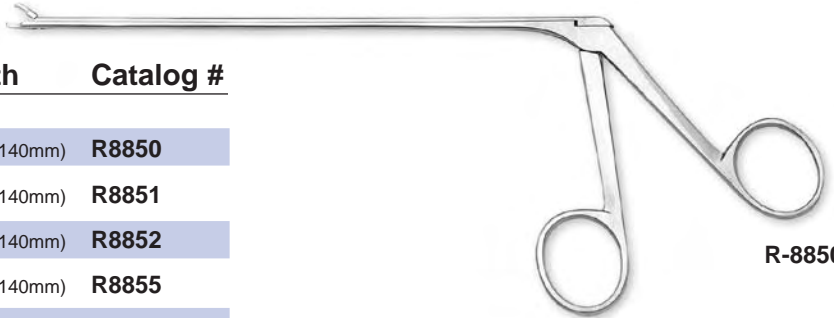

R-8850

RUGGLES™ Micro Alligator Grasping Forceps and Scissors Stationary Lower Jaw

	Length	Catalog #
With 2mm Round Cup	7" (178mm)	R8645
Without 2mm Round Cup	7" (178mm)	R8646
Scissors	7" (178mm)	R8647

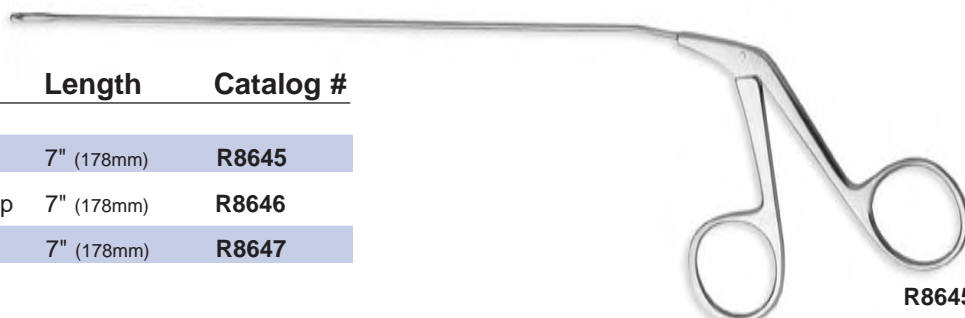

R8645

RUGGLES™ Ring Handled Microsurgical Scissors

	Length	Catalog #
8mm Blunt Straight	5 1/2" (140mm)	R8860
8mm Blunt Curved Right	5 1/2" (140mm)	R8861
8mm Blunt Curved Left	5 1/2" (140mm)	R8862

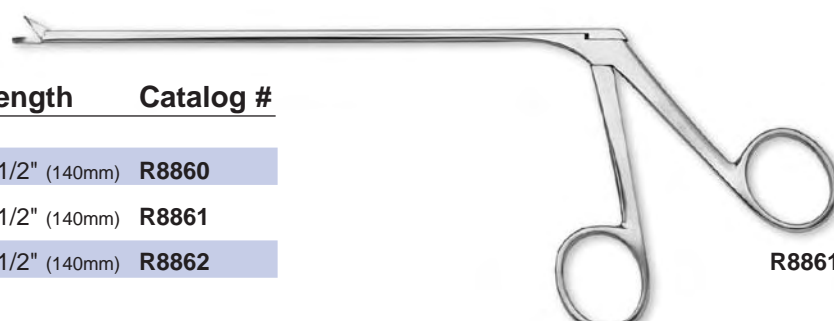

R8861

RUGGLES™ Belluci Micro Alligator Scissors

Blades	Length	Catalog #
Straight, Delicate	5 1/2" (140mm)	R8658
Curved, Delicate	5 1/2" (140mm)	R8659



R8658

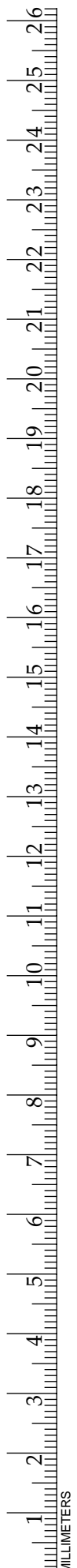

Transphenoidal Speculums

RUGGLES™ Transphenoidal Speculum

	Length	Catalog #
Black	2 3/4" (70mm)	RN2575
Black	3 1/8" (80mm)	RN2576
Black	3 9/16" (90mm)	RN2577
Black	3 15/16" (100mm)	RN2578



RN2578

RUGGLES™ Speculum

	Catalog #
13 x 70mm	R7401
13 x 88mm	R7402
13 x 110mm	R7403



R7401

RUGGLES™ Killian Septum Speculum

Blade	Catalog #
50mm	R8535
65mm	R8536
75mm	R8537
88mm	R8538



R8535



Transphenoidal Knives and Forceps

RUGGLES™ Swivel Knife



R8520

Catalog

Straight	3mm	R8520
Straight	4mm	R8521
Straight	5mm	R8522
Bayonet	3mm	R8525
Bayonet	4mm	R8526
Bayonet	5mm	R8527

RUGGLES™ Jansen–Middleton Forceps

Catalog

R8530



R8530



RUGGLES™ Fukushima Transphenoidal Micro Ring Curettes Length 9" (229mm)



T1 Curette

2mm **R8865**
30° Angle

R8865



T2 Curette

2mm **R8866**
45° Angle



T3 Curette

2.5mm **R8867**
30° Angle

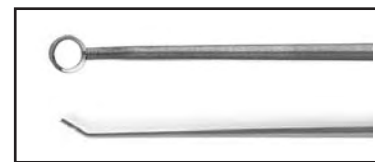

T4 Curette

2.5mm **R8868**
45° Angle

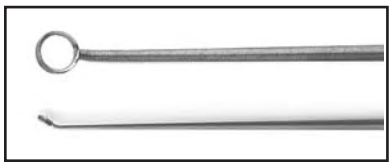

T5 Curette

3mm **R8869**
30° Angle



T6 Curette

3mm **R8870**
50° Angle



T7 Curette

4mm **R8871**
45° Angle

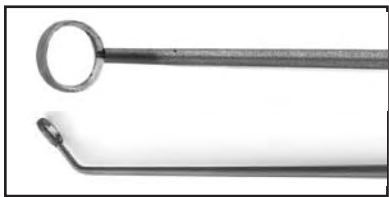

T8 Curette

5mm **R8872**
55° Angle



T9 Curette

6mm **R8873**
45° Angle



T10 Curette

7mm **R8874**
45° Angle



T11 Curette

5mm **R8875**
Malleable Shaft, Straight



Transphenoidal Instruments

RUGGLES™ Transphenoidal Bayonet Currettes, Length 9 3/4" (248mm)



Transphenoidal Bayonet Curette Set

RN6300

Includes one (1) each of items
RN6301 through RN6316 and
one (1) Instrument Tray RN6320



Curette

3mm **RN6301**
Angle Up

Transphenoidal Curette Tray

RN6320

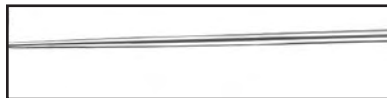

Curette

5mm **RN6302**
90° Angle Up



Curette

3mm **RN6303**
90° Angle Down



Curette

5mm **RN6304**
90° Angle Down



Curette

3mm **RN6305**
45° Angle Right



Curette

5mm **RN6306**
45° Angle Right



Curette

3mm **RN6307**
45° Angle Up



Curette

5mm **RN6308**
45° Angle Up



Curette

3mm **RN6323**
45° Angle Down



Curette

5mm **RN6324**
45° Angle Down

continued on next page

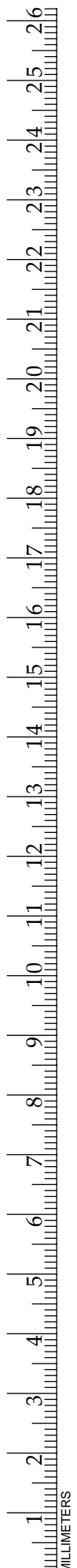

Transphenoidal Instruments

continued from previous page

RUGGLES™ Transphenoidal Instruments, Length 9 3/4" (248mm)

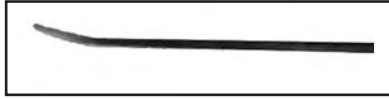

Dissector

Angle Up **RN6309**



Dissector

Angle Down **RN6310**



Enucleator

Bayonet **RN6311**
Micro, Left



Enucleator

Bayonet **RN6312**
Micro, Right



Enucleator

Bayonet **RN6313**
Standard, Left



Enucleator

Bayonet **RN6314**
Standard, Right



Knife Handle

Bayonet **RN6315**
Vertical

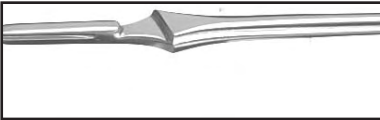

Knife Handle

Bayonet **RN6316**
Lateral



Endonasal Instruments

RUGGLES™ Cottle Septum Elevator



RN0326

Catalog #

Double Ended, Graduated RN0326

RUGGLES™ Endonasal Pituitary Hook



RN6021

Catalog #

45° Angled RN6021

RUGGLES™ Decker Forceps

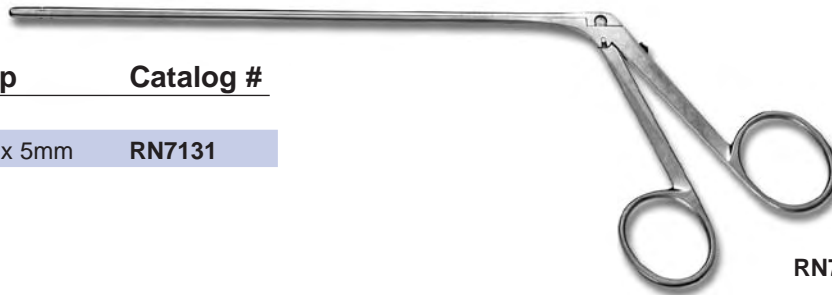

RN7131

Length Cup Catalog #

Straight 6" (152mm) 1.5 x 5mm RN7131

RUGGLES™ Weil-Blakesley Forceps



RN5423

Catalog #

45° Up #1 RN5423

Straight #1 RN5424



RUGGLES™ Septal Breaker

	Catalog #
Up Opening	RN0331
Down Opening	RN0332
Pair of Up and Down Opening	RN0330



RN0331

RUGGLES™ Kurze Dissecting Scissors

	Catalog #
Straight	RN7021
Curved Left	RN7022
Curved Right	RN7023



RN7021

RUGGLES™ Nasal Scissors

	Catalog #
Adult Straight	RN7061



RN7061



Endoscopic Endonasal Pituitary Instrument Set

RUGGLES™ Endoscopic Endonasal Pituitary Instrument Set

This universal and comprehensive instrument set is intended to be used in conjunction with the Universal Neuro-Endoscope Set to facilitate the endoscopic endonasal pituitary procedure. The set has also been designed with the versatility to accommodate standard microscopic transphenoidal surgical technique.

		Length	Catalog #
Endoscopic Endonasal Pituitary Set			RN5000
Septal Breaker	Up		RN0331
Cottle Septum Elevator	Double Ended, Graduated	8 1/2" (216mm)	RN0326
Micro Bayonet Curette	Straight, 3-0		RN0883
Micro Kerrison	2mm, 90° Down	8" (203mm)	RN4872
Micro Kerrison	2mm, 40° Up	8" (203mm)	RN4882
Sella Punch	1mm, 40° Up	8" (203mm)	RN4891
Weil Blakesely Forceps	40° Up, Size 1	4 1/2" (114mm)	RN5423
Weil Blakesely Forceps	Straight, Size 1	4 1/2" (114mm)	RN5424
Cushing IVD Rongeur	Straight, 2 x 10mm	7" (178mm)	RN5712H
Cushing IVD Rongeur	Up, 2 x 10mm	7" (178mm)	RN5722H
Cushing IVD Rongeur	Straight, 1.5 x 10mm	7" (178mm)	RN5780
Hook	45° Angle	9 3/4" (248mm)	RN6021
Transphenoidal Bayonet Curette	3mm, 90° Up	9 3/4" (248mm)	RN6301
Transphenoidal Bayonet Curette	5mm, 90° Up	9 3/4" (248mm)	RN6302
Transphenoidal Bayonet Curette	3mm, 90° Down	9 3/4" (248mm)	RN6303
Transphenoidal Bayonet Curette	5mm, 90° Down	9 3/4" (248mm)	RN6304
Transphenoidal Bayonet Curette	3mm, 45° Up	9 3/4" (248mm)	RN6307
Transphenoidal Bayonet Curette	5mm, 45° Up	9 3/4" (248mm)	RN6308
Transphenoidal Bayonet Curette	3mm, 45° Down	9 3/4" (248mm)	RN6323
Transphenoidal Bayonet Curette	5mm, 45° Down	9 3/4" (248mm)	RN6324
Kurze Dissecting Scissors	Straight	5 1/4" (133mm)	RN7021
Kurze Dissecting Scissors	Curved Left	5 1/4" (133mm)	RN7022
Kurze Dissecting Scissors	Curved Right	5 1/4" (133mm)	RN7023
Nasal Scissors	Straight	Adult	RN7061
Decker Forceps	Straight, 1.5 x 5mm Cup	6" (152mm)	RN7131
Suction Tube	5Fr., Angled Short Curved Up	8" (203mm)	RN82325
Suction Tube	7Fr., Angled Short Curved Up	8" (203mm)	RN82327
Suction Tube	5Fr., Angled Long Curved Up	8" (203mm)	RN82425
Suction Tube	7Fr., Angled Long Curved Up	8" (203mm)	RN82427
Suction Tube	5Fr., Angled Straight Tip	8" (203mm)	RN82525
Suction Tube	7Fr., Angled Straight Tip	8" (203mm)	RN82527
Suction Tube	11Fr., Angled Straight Tip	8" (203mm)	RN825211
Suction Tube	5Fr., Angled Short Curved Down	8" (203mm)	RN82625
Suction Tube	7Fr., Angled Short Curved Down	8" (203mm)	RN82627
Suction Tube	5Fr., Angled Long Curved Down	8" (203mm)	RN82725
Suction Tube	7Fr., Angled Long Curved Down	8" (203mm)	RN82727
Endonasal Pituitary Instrument Tray			RS5000

Optional Instruments:

Septal Breaker	Down		RN0332
Septal Breaker Set	Includes one (1) RN0331 and RN0332		RN0330

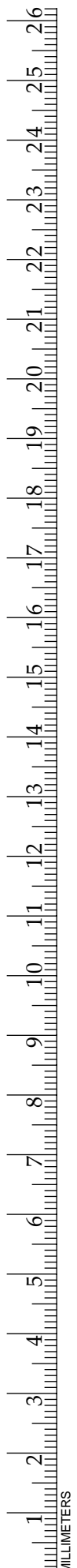

INSTRUMENT TRAYS

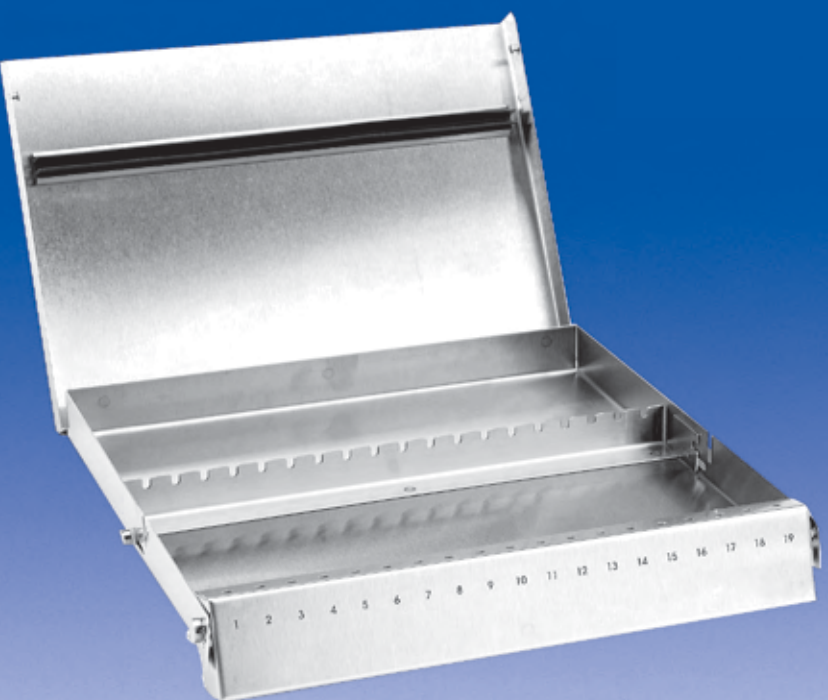

INSTRUMENT TRAYS

Retractor Instrument Trays

RUGGLES™ Anterior Cervical Fusion (ACF) Tray

Catalog #

R6298

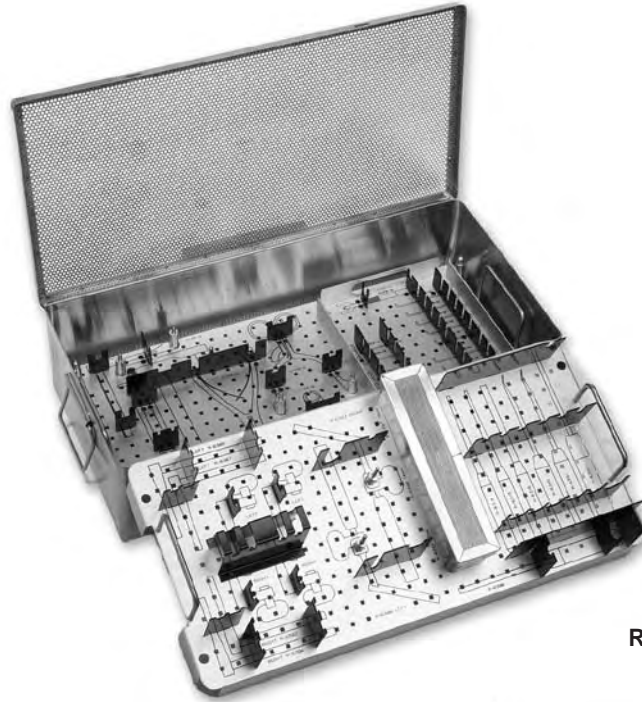

R6298

RUGGLES™ Spinal Retractor System Tray

Catalog #

RS2800



RS2800



Retractor Instrument Trays

RUGGLES™ Fukushima–Day Universal Retraction System Tray

Catalog #

R9105



R9105

RUGGLES™ Flexi–Spine™ Instrument Tray

Catalog #

RS2400

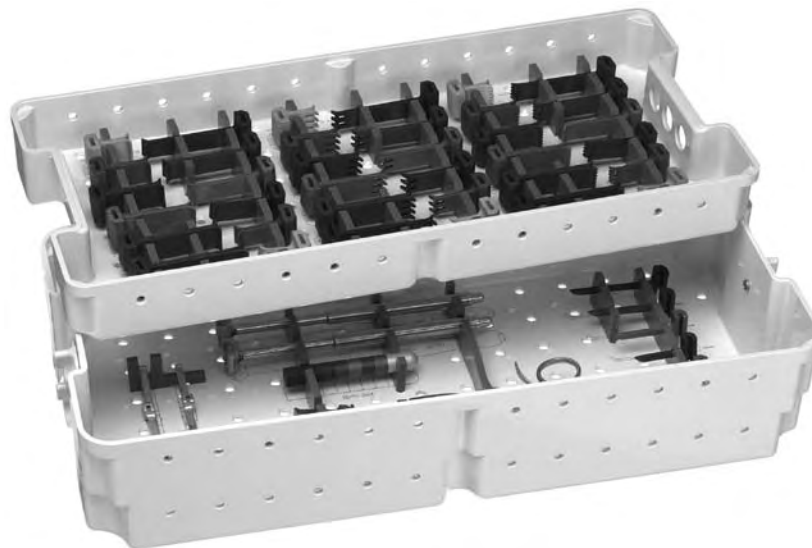

RS2400

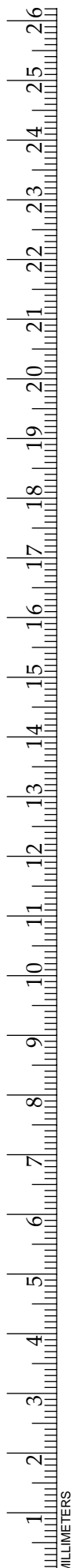

Curette Instrument Trays

RUGGLES™ Spinal Fusion Curette Tray

Catalog #

Single Level **R8113**
Holds 10-9" Curettes

Double Level **R8114**
Holds 20-9" Curettes



R8114

RUGGLES™ Spinal Fusion Curette Tray

Catalog #

Single Level **RS0900**
Holds 12-8" or 9" Curettes



RS0900



Curette Instrument Trays

RUGGLES™ Spinal Fusion Curette Tray

Catalog #

Single Level **R6523**
Holds 14-12" Curettes

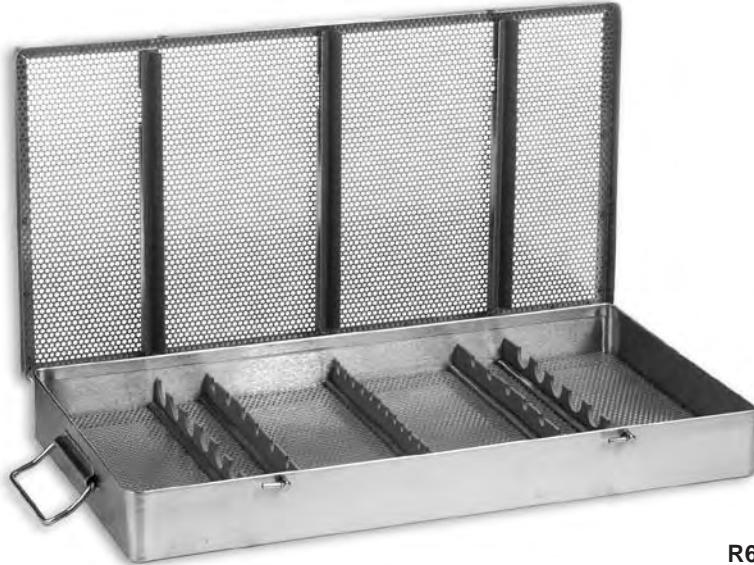

R6523

RUGGLES™ Sisco Bayonet Curette Tray

Catalog #

Single Level **R8113**
Holds 9-9" Bayonet Curettes

Double Level **R8114**
Holds 18-9" Bayonet Curettes



R-8114

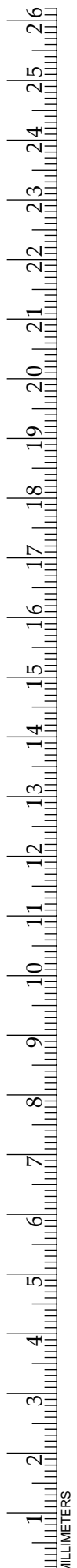

Curette Instrument Trays

RUGGLES™ Cervical Axial Curette Tray

Catalog #

Single Level **R8117**
Holds 10- Cervical Axial Curettes



R8117

RUGGLES™ Lumbar Axial Curette Tray

Catalog #

Single Level **R8118**
Holds 10- Lumbar Axial Curettes



R8118

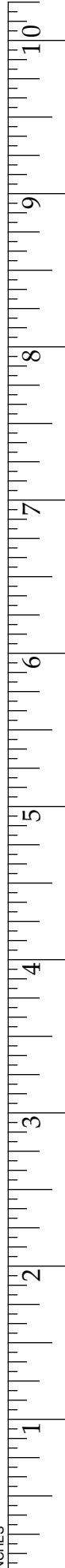

Microsurgical Instrument Trays

RUGGLES™ Fukushima-Giannotta Micro Tray

Catalog #

R8977

Holds R8935 through R8958

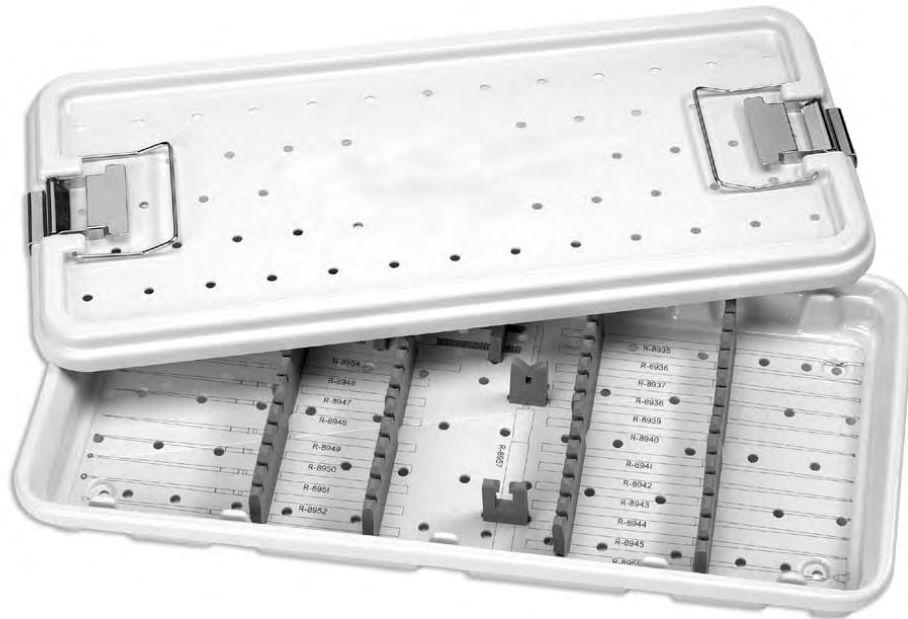

R8977



Microsurgical Instrument Trays

RUGGLES™ Micro Dissection Tray

Catalog

Angled **RS6600**
Holds RN6601 through RN6617

Single Level **RN6220**
Holds RN6201 through RN6215



RN6220

RUGGLES™ Extended Micro Dissection Tray

Catalog

Single Level **RS6219**
Holds RN6201 through RN6219



RS6219



Microsurgical Instrument Trays

RUGGLES™ Micro Ball Dissector Tray

Catalog #

Single Level **RS6215**
Holds RN6215 through RN6219



RS6215

RUGGLES™ Apfelbaum Dissection Tray

Catalog #

Straight **RS6700**
Holds RN6701 through RN6717

Angled **RS6600**
Holds RN6601 through RN6617



RS6700



Microsurgical Instrument Trays

RUGGLES™ Apfelbaum Bipolar Forceps Tray

Catalog #

Single Level **RS1120**
Holds RN1121 through RN1129N
14 1/2" L x 11 1/2" W x 1 1/2" D



RS1120

RUGGLES™ Micro Serrated Bayonet Scissors Tray

Catalog #

Sharp **RS8000**
Holds RN8001 through RN8009
Holds RN8001B through RN8009B

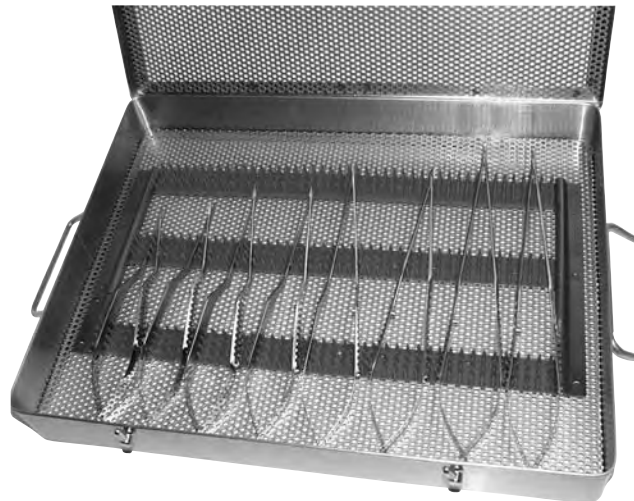

RS8000



Microsurgical Instrument Trays

RUGGLES™ Transphenoidal Curette Tray

Catalog #

Single Level **RN6320**
Holds RN6301 through RN6316



RN6320

RUGGLES™ Endonasal Pituitary Instrument Tray

Catalog #

RS5000



RS5000



INDEX

INDEX

A

ACCESS INSTRUMENTATION.....	1-30
ACF Complete System with Sterilization Tray.....	33
Adson Bayonet Forceps.....	166
Adson Cerebella Retractor.....	66
Adson Dissecting Hooks.....	188
Adson Dura Forceps.....	159
Adson Dura Hook.....	9
Adson Elevator.....	18
Adson Forceps with Tungsten-Carbide Inserts.....	159
Adson Hypophyseal Forceps.....	168
Adson Single Action Bone Rongeur.....	82
Adson Suction Tubes.....	150
Anderson-Adson Cerebella Retractor.....	66
Anterior Cervical Fusion (ACF) Retraction System.....	35-38
Anterior Cervical Fusion (ACF) Tray.....	34, 217
Apfelbaum Bipolar Bayonet Forceps.....	197
Apfelbaum Bipolar Forceps Tray.....	197, 225
Apfelbaum Dissection Tray.....	177-178, 224
Apfelbaum Dissector Set.....	177-178
Apfelbaum Extended Reach Curettes.....	132
Apfelbaum Micro Dissection Mirror.....	179
Atraumatic Tip Suction Tubes.....	149
Atraumatic Tip Suction Tubes with Multiple Holes.....	148

B

Ballenger Septum Elevator.....	21
Bayonet Forceps.....	165-168
Bayonet Suction Tubes.....	152
Beckman-Adson Retractor.....	67
Beckman-Eaton Retractor.....	67
Belluci Micro Alligator Scissors.....	206
Beyer Double Action Bone Rongeur.....	86
Biopsy Needles.....	186
Blade Ejector.....	37, 39, 41
Blade Retractor.....	55
Blunt Blades.....	44, 46
Blunt Micro Scissors Set.....	200
Bone Cutting Rongeurs.....	81
Bone Graft Harvesting Forceps.....	38
Bone Graft Holder.....	38
Bone Graft Impactors.....	28-29, 38
Brain Forceps.....	164
Brain Retractors.....	47-48
Brain Spatulas.....	49-50
Bunnel Hand Drill with Jacobs Chuck.....	5

C

C-Clamp.....	76
Caliper.....	38
Caspar Intervertebral Disc Rongeur.....	97
Cervical Axial Curettes.....	135
Cervical Axial Curette Tray.....	135, 221
Cervical Vertebra Spreader.....	57
Cloward Intervertebral Disc Rongeur.....	94

Cloward Lamina Spreader.....	57
Cobb Curette Tray.....	134
Cobb Spinal Elevator.....	23
Cobb Style Bone Curettes.....	133, 134
Cobb Type Gouge.....	27
Cone Ring Curettes.....	140
Contour Scalp Retractor.....	59
Cottle Septum Elevator.....	212
Cranial Burrs and Drills.....	3, 4, 5
Crille Ganglion Knife.....	8
CURETTES.....	121-142
Curette Instrument Trays.....	219-221
Curved Kerrison Rongeurs.....	119-120
Cushing Bayonet Forceps.....	165
Cushing Burr.....	3
Cushing Decompression Retractor.....	54
Cushing Delicate Pattern Intervertebral Disc Rongeurs.....	90
Cushing Dura Hook.....	9
Cushing Forceps.....	161
Cushing Intervertebral Disc Rongeur.....	90
Cushing Little Joker.....	19
Cushing Perforator Drill.....	3
Cushing Periosteal Elevator.....	19
Cushing Vein Retractor.....	54

D

D'Errico Nerve Root Retractor.....	51
D'Errico Perforator Drill.....	4
Dandy Nerve Hook.....	11
Dandy Scalp Hemostat.....	169
Dandy Trigeminal Scissors.....	30, 158
Davis Brain Spatula.....	49
Davis Nerve Separator and Spatula.....	14
Davis Scalp Retractor.....	59
Davis Spatula.....	15
Decker Forceps.....	212
Decker Intervertebral Disc Rongeur.....	99
Deeper Ducker Retractor.....	62
Delicate Neurosurgical Dissecting Scissors.....	158
Devilbliss Cranial Rongeur.....	81
Diamond Medium Kerrison Rongeur.....	106
Diamond Micro Kerrison Rongeur.....	103
Diamond Spurling Kerrison Rongeur.....	110
Dietrich Artery Scissors.....	157
Dietrich Tissue Forceps.....	163
Distraction Screws.....	34
Distractor.....	33-34
Dorsey Dura Separator.....	12
Double Action Bone Rongeurs.....	83-88
Double Ducker Retractor.....	62
Double Ended Dissector.....	15
Double Ended Dura Separator.....	12
Drill Guide.....	33-34
Ducker Retractor.....	62
Dural and Spinal Elevators.....	23
Dura Closure Needle Holder.....	171

Dura Dissectors and Elevators	14-15
Dura Hooks	9-10, 189
Dura Scissors	30, 158
Dura Separators	12-13

E

Early Spinal Fusion Knife	8
Echlin Double Action Bone Rongeur	86
Ejector Kerrison Rongeurs	117-118
Endonasal Instruments	212-213
Endonasal Pituitary Hook	212
Endonasal Pituitary Instrument Set	214
Endonasal Pituitary Instrument Tray	214, 226
Endonasal Suction Tubes	151
Epstein Curettes	141
Expanded Micro Dissection Set	175
Extended Micro Dissection Tray	223
Extended Reach Curettes	132
Extension Arm, Adjustable	76

F

F-G Series Fukushima-Giannotta Skullbase and Micro Dissectors	180-181
Feler-Ducker Retractor	63
Fenestrated Iliac Blades, Ball Snap	37
Ferris-Smith Intervertebral Disc Rongeur	99
Ferris-Smith Kerrison Rongeurs	114-116
Flatback Spinal Fusion Curettes	126-128
Flexi-Spine™ Depth Gauge	43
Flexi-Spine™ Instrument Tray	43, 218
Flexi-Spine™ Retraction System	43-44
Flexible Snake Arm	73
Forceps	159-170
Frazier Dura Hook	10
Frazier Dura Scissors	30, 158
Frazier Dura Separator	13
Frazier Suction Tubes	145-147
Freer Double Ended Dissector	14
Freer Elevator	14
Fukushima-Chen Cerebellar Pontine Tumor Bayonet Micro Dissectors	182
Fukushima-Day Retraction System	75-77
Fukushima-Day Universal Retraction System Tray	76, 218
Fukushima-Giannotta Micro Bayonet Needle Holder	201
Fukushima-Giannotta Micro Bayonet Scissors	201
Fukushima-Giannotta Micro Tray	222
Fukushima-Gianotta Periosteal Elevator	22
Fukushima Transphenoidal Micro Ring Curettes	209
Fulton Double Action Bone Rongeur	88

G

Gardner-Wells Traction Tongs	78
Gelpi Retractor	61
Gerald Bayonet Forceps	165
Gerald Forceps	162

Gerald Forceps with Tungsten-Carbide Inserts	162
Gigli Saws	6-7
Gigli Saw Blade	7
Gigli Saw Guide	7
Gigli Saw Handle	6
Gilles Tissue Forceps	164
Gouges	26-27
Gruenwald Bayonet Forceps	167

H

Hand-Held Retractors	54-56
Hand-Held Silicone Brain Retractors	47-48
Hardy Style Bipolar Bayonet Forceps	193-194
Hartman Alligator Forceps	169
Hercules Triple Action Wire Cutter	89
Hibbs Retractor	55
Hibbs Type Hemilaminectomy Blades	71
Hingeless Curved Kerrison Rongeur	120
Hoen Alligator Forceps	169
Hoen Bayonet Forceps	166
Hoen Dura Separator	12
Hoen Nerve Hook	11
Hoen Periosteal Elevator	21
Hoen Retractor	68
Holscher Nerve Root Retractor	52
Hook, Ball Snap	42
Hooks	44, 46
Horsley Dura Separator and Guard	13
Hudson Brace	5
Hudson Burr	3
Hudson Cranial Drill Set	5
Hudson Extension	4

I

Improved Cervical Lamina Spreader	57
Inge Lamina Spreader	58
Intervertebral Disc Rongeurs	90-99
Iris Bipolar Straight Forceps	192

J

Jackson Intervertebral Disc Rongeur	98
Jacobson Bayonet Forceps	167
Jacobson Micro Bayonet Needle Holder	203
Jacobson Micro Bayonet Scissors	199
Jacobson Micro Needle Holder	203
Jacobson Scissors	198
Janetta Double Round Bar	60
Janetta Malleable Blades	60
Janetta Retractor Body	60
Janetta Retractor Set	60
Janetta Single Round Bar	60
Jansen-Middleton Forceps	208
Jansen Bayonet Dressing Forceps	166
Jansen Deep Blade Scalp Retractor	59
Jansen Scalp Retractor	59

John Day Periosteal Elevator 22, 183
 Joseph Periosteal Elevator 20

K

Key Periosteal Elevator 20
 Killian Septum Speculum 207
 Knives and Retinaculotomes 8
 Krayenbuhl Hook 188
 Kurze Dissecting Scissors 213

L

Lahey Clinic Dura Hook 10
 Lambotte Osteotome 24
 Lamina Spreaders 57-58
 Langenbeck Periosteal Elevator 21
 Lateral Retractor Blades, Ball Snap 37
 Leksell Double Action Bone Rongeur 88
 Lempert Single Action Bone Rongeur 82
 Leyla Retraction System 73-74
 Ligamentum Flavum Forceps 169
 Longitudinal Retractor Blades, Ball Snap 36
 Longitudinal Retractor Body 35, 43, 45
 Longitudinal Retractor Set 35
 Long Bone Graft Impactor 28
 Long Teeth Blades 44, 46
 Love-Adson Elevator 18
 Love-Gruenwald Delicate Pattern Intervertebral
 Disc Rongeurs 91
 Love-Gruenwald Intervertebral Disc Rongeur 91
 Love Bayonet Nerve Root Retractor 52
 Love Nerve Root Retractor 52
 Lumbar and Cervical Impactor 29
 Lumbar Axial Curettes 136-137
 Lumbar Axial Curette Tray 136-137, 221

M

Markham-Meyerding Retractor 61
 Martin Nerve Root Retractor 51
 McCravey Tissue Forceps 164
 McIndoe Tissue Forceps 164
 McKenzie Enlarger Burr 4
 McKenzie Perforator Drill 4
 Medial Retractor Blades, Ball Snap 36
 Medium Kerrison Rongeurs 104-106
 Metzenbaum Dissecting Scissors 157
 Meyerding Retractor 55, 61
 Meyerding Type Hemilaminectomy Blades 71
 Micro-Angled Curettes 138
 Micro-Bayonet Curettes 138
 Microsurgical Bayonet Handle Hook 189
 Microsurgical Bipolar Bayonet Forceps 192
 Microsurgical Bipolar Forceps 192-197
 Microsurgical Curettes 138-139
 Microsurgical Dissection Instruments 175-184
 Microsurgical Forceps 191

Microsurgical Hooks 188-189
MICROSURGICAL INSTRUMENTATION 173-214
 Microsurgical Instrument Trays 222-226
 Microsurgical Needle Holders 203-204
 Microsurgical Ring Handled Forceps and Scissors 206
 Microsurgical Scissors 198-202
 Microsurgical Serrated Scissors 200
 Micro Alligator Grasping Forceps and Scissors 206
 Micro Arachnoidea Knife 190
 Micro Ball Dissector Set 175
 Micro Ball Dissector Tray 224
 Micro Bayonet Needle Holder 204
 Micro Bayonet Scissors 199
 Micro Curved Kerrison Rongeur 119
 Micro Discectomy Retractor 68
 Micro Disc Rongeur 98
 Micro Dissection Set 175, 179
 Micro Dissection Set Components 176
 Micro Dissection Tray 223
 Micro Ejector Kerrison Rongeurs 117-118
 Micro Forceps 191
 Micro Forceps with Catch 191
 Micro Kerrison Rongeurs 100-103
 Micro Lumbar Discectomy (MLD) Retraction System 39-40
 Micro Needle Holder 204
 Micro Ring Forceps 191
 Micro Scissors 198
 Micro Serrated Bayonet Scissors Tray 200, 225
 Micro Serrated Bayonet Scissors 200
 Micro Tissue Lifter 190
 Micro Tying Forceps 191
 Miskimon Cerebellum Retractor 65
 MLD Center Retractor Blades, Ball Snap 39
 MLD Retractor Body 39
 MLD Retractor Set 39
 Multi-Hole Suction Tubes 150
 Murphy Ball Hook 11, 189

N

Nasal Scissors 213
 Needle Holders 171, 203-205
 Nerve Hooks 11
 Nerve Root Retractors 51-53
 Neurosurgical Scissors 157-158

O

Oberhill Retractor 67
 Oldberg Dissector 17
 Olivecrona Alligator Scissors 157
 Olivecrona Double Ended Dissectors 14
 Open-Handled Kerrison Rongeurs 114
OPERATIONAL INSTRUMENTATION 155-172
 Osteotomes 24, 25
 Overhead Bar Fixation Base 73

P

Paine's Carpal Tunnel Retinaculotome	8
Peapod Intervertebral Disc Rongeurs	95
Penfield Dura Dissector.....	16
Periosteal Elevators.....	18-22
Periosteal Instruments.....	16-17
Poppen Intervertebral Disc Rongeurs	92
Poppen Suction Tubes	147
Potts-Smith Dressing Forceps.....	160
Potts-Smith Scissors	157
Potts-Smith Tissue Forceps.....	160
Presbyterian Hospital Staphylorrhaphy Elevators	15

R

Raney Clip Applying Forceps	30
Reichert Fixation Bases.....	73
Replacement Springs for C-Clamp.....	76
Retinaculotome.....	8
Retraction Systems	35-46, 73-77
RETRACTORS.....	31-78
Retractor Blade Handle	44-45
Retractor Instrument Trays.....	217-218
Ring Handled Microsurgical Forceps.....	206
Ring Handled Microsurgical Scissors.....	206
Rochester-Pean Forceps.....	170
RONGEURS, KERRISONS AND IVDS.....	79-120
Round Bayonet Handle Micro Curettes	139
Round Handled Instruments.....	184
Ruler.....	171
Ruskin-Liston Bone Cutting Rongeurs	81
Ruskin Double Action Bone Rongeurs	85

S

Sachs Dura Hook	9
Sachs Dura Separator	13
Sachs Dura Separator and Guard.....	12
Sachs Nerve Separator and Spatula.....	15
Scalp Hooks	77
Scalp Retractors	59
Scoville-Green Style Bipolar Bayonet Forceps.....	194
Scoville Blades, Ball Snap.....	42
Scoville Haverfield Hemilaminectomy Retractor Body	69
Scoville Nerve Root Retractors	51
Scoville Retractor Body	41
Scoville Ruptured Disc Curettes.....	129
Scoville Type Hemilaminectomy Blades.....	70
Scoville Type Hemilaminectomy Hook Blades	70
Scoville Type Hemilaminectomy Retractor Body.....	69
Screwdriver.....	33
Sedillot Elevator.....	21
Self-Retaining Retractors	60-72
Seltz-Gelpi Retractor	61
Semken Bipolar Straight Forceps.....	192
Semken Forceps	162

Semken Forceps with Tungsten-Carbide Inserts.....	163
Semmes Spinal Fusion Curettes.....	141
Senn Retractor	54
Septal Breaker.....	213
Sharp Micro Scissors Set.....	200
Short Teeth Blades	44, 46
Silicone Brain Retractor.....	47-48
Single Action Bone Rongeurs.....	82
Sisco Bayonet Curettes	142
Sisco Bayonet Curette Tray.....	142, 220
Smith-Peterson Double Action Bone Rongeur	87
Smith-Peterson Gouge.....	26
Smith-Peterson Osteotome	25
Spatula Support.....	73
Specialty Curettes	141
Speculum.....	207
Speculum Retractor.....	40
Spinal Fusion Curettes	123-125, 130
Spinal Fusion Curettes - Flatback	126-128
Spinal Fusion Curettes - Hollow Handle.....	130
Spinal Fusion Curettes - Standard Back	123-125
Spinal Fusion Curette Tray.....	124, 128, 130-131, 219-220
Spinal Retraction System	45-46
Spinal Retractor System Tray.....	217
Spurling Delicate Pattern Intervertebral Disc Rongeur.....	93
Spurling Ejector Kerrison Rongeur	117
Spurling Intervertebral Disc Rongeur	93-94
Spurling Kerrison Rongeurs	107-113
Stainless Steel Ruler	171
Star Clamp.....	77
Stealth Ferris-Smith Kerrison Rongeurs.....	116
Stealth Hingeless Curved Kerrison Rongeurs.....	120
Stealth Medium Kerrison Rongeur	105
Stealth Micro Ejector Kerrison Rongeur	118
Stealth Micro Kerrison Rongeur	102
Stealth Spurling Kerrison Rongeur	109, 113
Stille-Echlin Double Action Bone Rongeur	83
Stille-Horsley Bone Cutting Rongeur.....	81
Stille-Liston Bone Cutting Rongeur	81
Stille-Luer Double Action Bone Rongeur.....	84
Stille-Luer Duckbill Double Action Bone Rongeur	84
Stille Double Action Bone Rongeur	83
Stookey Single Action Bone Rongeur.....	82
Strully-Gigli Saw Handle.....	6
Strully Dura Twist Hook	10
Strully Neurosurgical Scissors.....	158
Suction Nerve Retractor	53, 154
SUCTION TUBES	143-154
Swivel Knife	208

T

T-Bars, Ball Snap.....	42
T. Fukushima Brain Spatula.....	50
T. Fukushima Dural Elevator and Spatula	23, 183
T. Fukushima Dura Spatula	50

T. Fukushima Periosteal Elevator	22
T. Fukushima Tapered Teardrop Suction Tubes	153
Table Clamp.....	76
Table Mounting Hardware.....	74
Tapered Teardrop Suction Tubes.....	153-154
Taylor Blades, Ball Snap.....	42
Taylor Dura Scissors.....	30, 158
Taylor Spinal Retractor	56
Taylor Type Hemilaminectomy Blades.....	71-72
Tew Spurling Kerrison Rongeur.....	111
Thoraco-Lumbar Curettes	131
Thumb Forceps	163
Tip Guards.....	172
Titanium Bayonet Diamond Knife	187
Titanium Bayonet Needle Holder.....	205
Titanium Bayonet Scissors	202
Titanium Biopsy Needle.....	186
Titanium Bipolar Bayonet Forceps	196
Titanium Diamond Knives.....	187
Titanium Microsurgical Bipolar Forceps	196-197
Titanium Microsurgical Needle Holders	205
Titanium Microsurgical Scissors	202
Titanium Probe	185
Titanium Round Handled Bayonet Needle Holders	205
Titanium Round Handled Bayonet Scissors	202
Titanium Round Handled Straight Scissors	202
Titanium Straight Diamond Knife.....	187
Titanium Straight Scissors.....	202
Titanium Vascular Instruments	185
Traction Tongs	78
Transphenoidal Bayonet Curettes	210
Transphenoidal Curettes Instruments	209
Transphenoidal Curette Tray	226
Transphenoidal Hypophysectomy Bipolar Bayonet Forceps	192
Transphenoidal Instruments	209-211
Transphenoidal Knives and Forceps	208
Transphenoidal Speculums	207
Transverse Retractor Body.....	35, 43, 45
Transverse Retractor Set	35
Twist Drill	33

U

U-Bar	76
UMLD Retractor Blades.....	41
Universal Micro Lumbar Discectomy (UMLD) Retraction System.....	41-42
Universal Snake	77
US Army Retractor.....	55

V

Vertebral Body Dissector	38
Vertebral Body Distraction System	33-34
Vinyl Tip Guards	172
Volkman Retractor	54

W

Weary Nerve Hook	188
Weil-Blakesley Forceps	212
Weitlaner Angled Self-Retaining Retractor	65
Weitlaner Hinged Self-Retaining Retractor.....	65
Weitlaner Self-Retaining Retractor	64
Wilde Intervertebral Disc Rongeur.....	96
Williams Style Discectomy Retractor.....	63
Woodson Double Ended Packer	17
Woodson Dura Separator and Packer.....	17
Woodson Elevator	17
Woodson Elevator and Spatula	17

Y

Yasargil Bayonet Forceps.....	168
Yasargil Bayonet Tumor Forceps	168
Yasargil Ligature Carrier.....	190
Yasargil Micro Bayonet Needle Holder.....	204
Yasargil Micro Bayonet Scissors	199
Yasargil Style Bipolar Bayonet Forceps	195

Z

Zaufal-Jansen Double Action Bone Rongeur	86
--	----

RUGGLES™ Numerical Index

651200.....	187	R0040.....	3	R0278.....	21	R0425.....	159	R0678.....	148
651210.....	187	R0041.....	3	R0279.....	21	R0427.....	159	R0679.....	148
651214.....	187	R0042.....	3	R0280.....	21	R0429.....	159	R0680.....	148
651301.....	185	R0043.....	3	R0281.....	21	R0430.....	159	R0681.....	148
651302.....	185	R0060.....	4	R0285.....	19	R0431.....	164	R0682.....	148
651303.....	185	R0065.....	4	R0286.....	19	R0432.....	164	R0707.....	147
651304.....	185	R0070.....	4	R0287.....	21	R0433.....	161	R0708.....	147
651305.....	185	R0075.....	5	R0289.....	19	R0434.....	161	R0710.....	147
651306.....	185	R0076.....	5	R0290.....	19	R0435.....	162	R0711.....	147
651307.....	185	R0080.....	4	R0291.....	19	R0437.....	162	R0712.....	147
651308.....	185	R0085.....	5	R0294.....	23	R0439.....	160	R0713.....	147
651309.....	185	R0088.....	5	R0295.....	18	R0440.....	162	R0714.....	147
651310.....	185	R0175.....	14	R0296.....	23	R0442.....	162	R0715.....	147
651311.....	185	R0176.....	14	R0297.....	23	R0445.....	161	R0716.....	147
651312.....	185	R0177.....	14	R0298.....	23	R0447.....	164	R0770.....	147
651313.....	185	R0178.....	14	R0299.....	23	R0448.....	164	R0771.....	147
651365.....	202	R0200.....	9	R0300.....	25	R0449.....	161	R0772.....	147
651366.....	202	R0205.....	9	R0301.....	25	R0455.....	164	R0773.....	147
651367.....	202	R0210.....	10	R0302.....	25	R0458.....	166	R0774.....	147
651368.....	202	R0212.....	10	R0303.....	25	R0459.....	166	R0775.....	147
651369.....	202	R0215.....	10	R0304.....	25	R0460.....	166	R0776.....	147
651370.....	202	R0225.....	12	R0305.....	25	R0461.....	166	R0777.....	147
651371.....	202	R0231.....	12	R0306.....	25	R0462.....	166	R0778.....	147
651375.....	202	R0233.....	12	R0310.....	25	R0463.....	166	R0785.....	147
651376.....	202	R0235.....	12	R0311.....	25	R0475.....	168	R0786.....	147
651377.....	202	R0236.....	12	R0312.....	25	R0476.....	168	R0787.....	147
651378.....	202	R0240.....	14	R0313.....	25	R0477.....	168	R0788.....	147
651388.....	205	R0243.....	14	R0314.....	25	R0478.....	163	R0789.....	147
651389.....	205	R0244.....	14	R0315.....	25	R0479.....	163	R0790.....	147
651390.....	205	R0245.....	15	R0316.....	25	R0480.....	160	R0791.....	147
651394.....	205	R0246.....	15	R0360B.....	124	R0481.....	160	R0845.....	188
651395.....	205	R0247.....	15	R0361B.....	124	R0482.....	160	R0848.....	11, 189
651600.....	186	R0248.....	13	R0362B.....	124	R0485.....	160	R0855.....	188
651601.....	186	R0250.....	8	R0363B.....	124	R0486.....	160	R0856.....	188
651605.....	186	R0252.....	15	R0364B.....	124	R0487.....	160	R0860.....	11
NL7702701.....	47	R0256.....	19	R0365B.....	124	R0500.....	169	R0861.....	11
NL7702702.....	47	R0259.....	15	R0366B.....	124	R0503.....	169	R0862.....	11
NL7702703.....	47	R0260.....	18	R0367B.....	124	R0504.....	169	R0924.....	49
NL7702704.....	47	R0261.....	18	R0368B.....	124	R0506.....	169	R0924A.....	49
NL7702705.....	47	R0262.....	18	R0370.....	129	R0507.....	169	R0925.....	49
NL7702707.....	47	R0263.....	18	R0371.....	129	R0515.....	8	R0925A.....	49
NL7702708.....	47	R0265.....	17	R0372.....	129	R0520.....	8	R0926.....	49
NL8700200.....	47	R0266.....	17	R0400.....	161	R0521.....	8	R0926A.....	49
NL8700204.....	47	R0267.....	17	R0402.....	161	R0658.....	147	R0927.....	49
NL8700206.....	47	R0268.....	17	R0403.....	159	R0659.....	147	R0927A.....	49
NL8700208.....	47	R0269.....	20	R0404.....	159	R0660.....	147	R0928.....	49
NL8700210.....	47	R0270.....	20	R0405.....	161	R0661.....	147	R0928A.....	49
NL8700214.....	47	R0271.....	20	R0410.....	161	R0662.....	147	R0929.....	49
R0010.....	3	R0272.....	20	R0412.....	161	R0663.....	147	R0929A.....	49
R0015.....	3	R0273.....	20	R0413.....	161	R0664.....	147	R0930.....	49
R0020.....	3	R0274.....	20	R0416.....	165	R0674.....	148	R0930A.....	49
R0025.....	3	R0275.....	20	R0419.....	159	R0675.....	148	R1000.....	51
R0030.....	3	R0276.....	20	R0421.....	165	R0676.....	148	R1005.....	51
R0035.....	3	R0277.....	21	R0423.....	159	R0677.....	148	R1007.....	51

R1024.....	52	R1155.....	59	R1305.....	81	R15104.....	100	R1577.....	111
R1025.....	52	R1160.....	59	R1306.....	81	R15105.....	100	R1578.....	111
R1026.....	52	R1165.....	67	R1307.....	81	R15106.....	100	R1579.....	111
R1027.....	52	R1166.....	67	R1310.....	81	R15156.....	100	R1580.....	114
R1050.....	57	R1170.....	67	R1312.....	81	R15206.....	100	R1582.....	114
R1054.....	57	R1175.....	67	R1320.....	82	R15302.....	100	R1586.....	114
R1060.....	55	R1189.....	66	R1324.....	82	R15303.....	100	R1587.....	114
R1061.....	55	R1190.....	66	R1325.....	82	R15304.....	100	R1590.....	114
R1062.....	55	R1194.....	66	R1326.....	82	R15305.....	100	R1591.....	114
R1070.....	58	R1195.....	66	R1327.....	82	R15306.....	100	R1592.....	114
R1075.....	58	R1197.....	66	R1330.....	82	R15353.....	100	R1593.....	114
R1080.....	56	R1200.....	64	R1338.....	85	R15354.....	100	R1595.....	114
R1085.....	56	R1201.....	64	R1339.....	85	R15355.....	100	R15952.....	107
R1090.....	55	R1205.....	64	R1340.....	85	R15356.....	100	R15953.....	107
R1091.....	55	R1206.....	64	R1341.....	85	R15403.....	100	R15954.....	107
R1092.....	55	R1208.....	65	R1342.....	85	R15404.....	100	R15955.....	107
R1093.....	55	R1209.....	65	R1343.....	85	R15405.....	100	R15956.....	107
R1095.....	54	R1210.....	64	R1344.....	85	R15406.....	100	R1596.....	114
R1096.....	55	R1211.....	64	R1350.....	86	R1545.....	111	R1601.....	100
R1100.....	54	R1215.....	64	R1355.....	86	R15453.....	100	R1602.....	100
R1106.....	69	R1216.....	64	R1370.....	86	R15454.....	100	R1603.....	100
R1111.....	69	R12164.....	28	R1375.....	86	R15455.....	100	R1604.....	100
R1113.....	70	R12165.....	28	R1380.....	86	R15456.....	100	R1605.....	100
R1114.....	70	R12166.....	28	R1381.....	87	R1546.....	111	R16052.....	107
R1115.....	70	R12167.....	28	R1382.....	87	R1547.....	111	R16053.....	107
R1116.....	70	R12168.....	28	R1383.....	87	R1548.....	111	R16054.....	107
R1118.....	70	R12169.....	28	R1385.....	83	R1549.....	111	R16055.....	107
R1119.....	70	R1217.....	65	R1386.....	87	R15502.....	100	R1606.....	100
R1120.....	70	R12170.....	28	R1387.....	87	R15503.....	100	R1607.....	100
R1121.....	70	R12171.....	28	R1388.....	87	R15504.....	100	R1608.....	100
R1123.....	70	R1218.....	65	R1390.....	88	R15505.....	100	R1609.....	100
R1124.....	70	R1220.....	64	R1391.....	88	R15506.....	100	R1610.....	100
R1126.....	71	R1221.....	64	R1392.....	88	R1551.....	111	R16102.....	107
R1127.....	71	R1225.....	65	R1445.....	88	R1552.....	111	R1611.....	100
R1128.....	71	R1226.....	65	R1450.....	88	R1553.....	111	R1612.....	100
R1130.....	71	R1230.....	65	R1455.....	88	R1554.....	111	R1613.....	100
R1131.....	71	R1231.....	65	R1458.....	88	R15553.....	100	R1614.....	100
R1134.....	71	R1233.....	54	R1460.....	88	R15554.....	100	R1615.....	100
R1135.....	71	R1234.....	54	R1465.....	88	R15555.....	100	R16252.....	107
R1136.....	71	R1235.....	54	R1470.....	83	R15556.....	100	R16253.....	107
R1137.....	71	R1236.....	54	R1475.....	83	R15603.....	100	R16254.....	107
R1138.....	71	R1237.....	54	R1480.....	83	R15604.....	100	R16255.....	107
R1139.....	71	R1238.....	54	R1490.....	100	R15605.....	100	R1635.....	117
R1140.....	71	R1239.....	54	R1491.....	100	R15606.....	100	R1636.....	117
R1142.....	71	R1240.....	54	R1492.....	100	R15653.....	100	R1637.....	117
R1143.....	71	R1272.....	61	R1493.....	100	R15654.....	100	R1638.....	117
R1144.....	71	R1273.....	61	R1494.....	100	R15655.....	100	R16403.....	117
R1145.....	71	R1275.....	61	R1495.....	100	R15656.....	100	R16404.....	117
R1146.....	72	R1280.....	61	R1496.....	100	R1571.....	111	R16405.....	117
R1147.....	72	R1285.....	61	R1497.....	100	R1572.....	111	R1648.....	100
R1148.....	72	R1290.....	61	R1498.....	100	R1573.....	111	R1649.....	100
R1149.....	72	R1297.....	54	R1499.....	100	R1574.....	111	R16501.....	100
R1150.....	59	R1298.....	54	R15102.....	100	R1575.....	111	R16502.....	100
R1151.....	59	R1300.....	81	R15103.....	100	R1576.....	111	R16503.....	100

RUGGLES™ Numerical Index

R16504.....	100	R1723.....	95	R2004.....	130	R2265.....	26	R2828.....	127
R16505.....	100	R1724.....	95	R2005.....	130	R2266.....	26	R2829.....	127
R16506.....	100	R1745.....	98	R2006.....	130	R2270.....	26	R2830.....	127
R1651.....	107	R1758.....	94	R2007.....	130	R2271.....	26	R2839.....	128
R1652.....	107	R1759.....	94	R2008.....	130	R2272.....	26	R2840.....	128
R1653.....	107	R1765.....	92	R2010.....	130	R2273.....	26	R2841.....	128
R1654.....	107	R1766.....	92	R2011.....	130	R2274.....	26	R2842.....	128
R16552.....	107	R1767.....	92	R2012.....	130	R2275.....	26	R2843.....	128
R16553.....	107	R1785.....	92	R2013.....	130	R2276.....	26	R2844.....	128
R16554.....	107	R1786.....	92	R2014.....	130	R2381.....	74	R2845.....	128
R16555.....	107	R1787.....	92	R2015.....	130	R2382.....	74	R2846.....	128
R16602.....	107	R1790.....	94	R2016.....	130	R2383.....	74	R2847.....	128
R16603.....	107	R1791.....	94	R2017.....	130	R2384.....	74	R2848.....	128
R16604.....	107	R1792.....	94	R2018.....	130	R2385.....	74	R2849.....	128
R16605.....	107	R18045.....	92	R2200.....	24	R2389.....	73	R2850.....	128
R1661.....	107	R18055.....	92	R2201.....	24	R2390.....	73	R2851.....	128
R1662.....	107	R18065.....	92	R2202.....	24	R2391.....	73	R2852.....	128
R1663.....	107	R18165.....	92	R2203.....	24	R2396.....	73	R2853.....	128
R1664.....	107	R18175.....	92	R2204.....	24	R2397.....	73	R2854.....	128
R1665.....	100	R18185.....	92	R2205.....	24	R2398.....	73	R2855.....	128
R16652.....	107	R18402.....	97	R2210.....	24	R2399.....	73	R2856.....	128
R16653.....	107	R18403.....	97	R2211.....	24	R2400.....	73	R2857.....	128
R16654.....	107	R18404.....	97	R2212.....	24	R2620.....	192	R2858.....	128
R16655.....	107	R18405.....	97	R2213.....	24	R2640.....	192	R2859.....	128
R1666.....	100	R18453.....	97	R2214.....	24	R2645.....	192	R2860.....	142
R1667.....	100	R18454.....	97	R2215.....	24	R2646.....	192	R2861.....	142
R16702.....	119	R18455.....	97	R2220.....	133	R2691.....	196	R2862.....	142
R16703.....	119	R18503.....	97	R2221.....	133	R2692.....	196	R2863.....	142
R16703L.....	119	R18504.....	97	R2222.....	133	R2693.....	196	R2864.....	142
R16703R.....	119	R18615.....	92	R2223.....	133	R2694.....	196	R2865.....	142
R16704.....	119	R18625.....	92	R2224.....	133	R2696.....	192	R2866.....	142
R16705.....	119	R18635.....	92	R2225.....	133	R2697.....	192	R2867.....	142
R16706.....	119	R1905.....	158	R2226.....	133	R2698.....	192	R2868.....	142
R1671.....	107	R1916.....	157	R2227.....	133	R2799.....	126	R2870.....	142
R1672.....	107	R1917.....	157	R2228.....	133	R2800.....	126	R2871.....	142
R1673.....	107	R1918.....	157	R2230.....	134	R2801.....	126	R2872.....	142
R1674.....	107	R1920.....	158	R2231.....	134	R2802.....	126	R2873.....	142
R16752.....	107	R1921.....	157	R2232.....	134	R2803.....	126	R2874.....	142
R16753.....	107	R1922.....	157	R2233.....	134	R2804.....	126	R2875.....	142
R16754.....	107	R1923.....	157	R2234.....	134	R2805.....	126	R2876.....	142
R16755.....	107	R1924.....	157	R2235.....	134	R2806.....	126	R2877.....	142
R16802.....	107	R1925.....	157	R2236.....	134	R2807.....	126	R2878.....	142
R16803.....	107	R1926.....	157	R2237.....	134	R2808.....	126	R2881.....	142
R16804.....	107	R1942.....	78	R2238.....	134	R2809.....	126	R2882.....	142
R16805.....	107	R1944.....	78	R2240.....	27	R2810.....	126	R2883.....	142
R1711.....	96	R1944TS.....	78	R2241.....	27	R2819.....	127	R2884.....	142
R1712.....	96	R1945.....	78	R2242.....	27	R2820.....	127	R2885.....	142
R1713.....	96	R1946.....	78	R2243.....	27	R2821.....	127	R2886.....	142
R1714.....	96	R1947.....	78	R2250.....	134	R2822.....	127	R2891.....	142
R1716.....	96	R1949.....	78	R2260.....	26	R2823.....	127	R2892.....	142
R1717.....	96	R2000.....	130	R2261.....	26	R2824.....	127	R2893.....	142
R1718.....	96	R2001.....	130	R2262.....	26	R2825.....	127	R2894.....	142
R1719.....	96	R2002.....	130	R2263.....	26	R2826.....	127	R2895.....	142
R1722.....	95	R2003.....	130	R2264.....	26	R2827.....	127	R2896.....	142

R3001.....	163	R6367A.....	34	R6518.....	131	R6642.....	42	R7337.....	184
R3002.....	163	R6370.....	36	R6519.....	131	R6643.....	42	R7338.....	184
R3003.....	163	R6371.....	36	R6520.....	131	R6644.....	42	R7339.....	184
R3004.....	163	R6372.....	36	R6521.....	131	R6740.....	137	R7340.....	184
R3006.....	163	R6373.....	36	R6523.....	130, 131, 220	R6741.....	137	R7341.....	184
R3007.....	163	R6374.....	36	R6530.....	137	R6742.....	137	R7342.....	184
R3008.....	163	R6375.....	37	R6531.....	137	R6743.....	137	R7343.....	184
R3010.....	163	R6376.....	37	R6532.....	137	R6744.....	137	R7344.....	184
R3011.....	163	R6377.....	37	R6533.....	137	R6745.....	137	R7350.....	139
R3012.....	163	R6378.....	37	R6534.....	137	R6746.....	137	R7351.....	139
R3013.....	163	R6379.....	37	R6535.....	137	R6747.....	137	R7352.....	139
R3015.....	163	R6380.....	35	R6536.....	137	R6748.....	137	R7353.....	139
R3016.....	163	R6381.....	36	R6537.....	137	R6749.....	137	R7360.....	139
R3017.....	163	R6382.....	36	R6538.....	137	R6750.....	137	R7361.....	139
R3090.....	170	R6383.....	36	R6539.....	137	R6751.....	137	R7362.....	139
R3091.....	170	R6384.....	36	R6540.....	29	R6752.....	137	R7363.....	139
R3092.....	170	R6385.....	36	R6541.....	29	R6753.....	137	R7365.....	139
R3093.....	170	R6386.....	35	R6542.....	29	R6754.....	137	R7366.....	139
R3094.....	170	R6387.....	33	R6543.....	29	R6755.....	137	R7367.....	139
R3095.....	170	R6388.....	33	R6544.....	29	R6756.....	137	R7368.....	139
R3096.....	170	R6389.....	33	R6545.....	29	R6757.....	137	R7370.....	139
R3097.....	170	R6390.....	38	R6546.....	29	R6758.....	137	R7371.....	139
R3098.....	170	R6391.....	38	R6547.....	29	R6759.....	137	R7372.....	139
R3099.....	170	R6392.....	34	R6548.....	29	R7250.....	63	R7373.....	139
R3320.....	89	R6393.....	34	R6550.....	36	R7251.....	63	R7401.....	207
R3321.....	89	R6394.....	34	R6551.....	36	R7252.....	63	R7402.....	207
R3325.....	89	R6396.....	33	R6552.....	36	R7253.....	63	R7403.....	207
R3549.....	171	R6397A.....	34	R6553.....	36	R7254.....	63	R8113 ...	124, 128, 142,
R5501.....	172	R6398A.....	34	R6554.....	36	R7255.....	63	219, 220
R5502.....	172	R6399.....	38	R6555.....	36	R7260.....	63	R8114 ...	124, 128, 142,
R5503.....	172	R6405.....	39	R6556.....	36	R7261.....	63	219, 220
R5504.....	172	R6406.....	39	R6557.....	36	R7262.....	63	R8117.....	135, 221
R5505.....	172	R6407.....	39	R6558.....	36	R7263.....	63	R8118 ...	136, 137, 221
R5506.....	172	R6408.....	39	R6559.....	36	R7264.....	63	R8210.....	204
R5507.....	172	R6409.....	39	R6560.....	37	R7265.....	63	R8220.....	203
R5508.....	172	R6410.....	39	R6561.....	37	R7305.....	189	R8230.....	191
R5509.....	172	R6411.....	39	R6562.....	37	R7306.....	189	R8231.....	191
R6000.....	33	R6412.....	39	R6563.....	37	R7307.....	189	R8234.....	189
R6298.....	34, 217	R6413.....	40	R6564.....	37	R7308.....	189	R8235.....	189
R6310.....	37, 39, 41	R6414.....	40	R6579.....	41	R7309.....	189	R8250.....	191
R6312.....	35	R6415.....	40	R6601.....	41	R7310.....	189	R8251.....	191
R6313.....	35	R6416.....	40	R6602.....	41	R7315.....	189	R8256.....	204
R6314.....	38	R6417.....	40	R6603.....	41	R7316.....	189	R8257.....	204
R6315.....	38	R6418.....	40	R6604.....	41	R7317.....	189	R8312.....	198
R6316.....	38	R6506.....	131	R6621.....	42	R7318.....	189	R8401.....	179
R6317.....	38	R6507.....	131	R6622.....	42	R7320.....	189	R8402.....	179
R6318.....	38	R6510.....	131	R6623.....	42	R7321.....	189	R8403.....	179
R6319.....	38	R6511.....	131	R6624.....	42	R7330.....	184	R8408.....	179
R6320.....	37	R6512.....	131	R6630.....	41	R7331.....	184	R8409.....	179
R6321.....	37	R6513.....	131	R6631.....	41	R7332.....	184	R8410.....	179
R6322.....	53	R6514.....	131	R6632.....	41	R7333.....	184	R8411.....	179
R6323.....	53	R6515.....	131	R6633.....	41	R7334.....	184	R8412.....	179
R6324.....	53	R6516.....	131	R6640.....	42	R7335.....	184	R8413.....	179
R6337.....	38	R6517.....	131	R6641.....	42	R7336.....	184	R8414.....	179

R8415.....	179	R8797.....	136	R8870.....	209	R8943.....	180	R8990SM.....	154
R8416.....	179	R8798.....	136	R8871.....	209	R8944.....	180	R8991.....	153
R8445.....	190	R8799.....	136	R8872.....	209	R8945.....	180	R8991SM.....	154
R8510.....	190	R8800.....	135	R8873.....	209	R8946.....	181	R8992.....	153
R8515.....	190	R8801.....	135	R8874.....	209	R8947.....	181	R8992SM.....	154
R8520.....	208	R8802.....	135	R8875.....	209	R8948.....	181	R8993.....	153
R8521.....	208	R8803.....	135	R8876.....	182	R8949.....	181	R8993SM.....	154
R8522.....	208	R8804.....	135	R8877.....	182	R8950.....	181	R8994.....	153
R8525.....	208	R8805.....	135	R8878.....	182	R8951.....	181	R8994SM.....	154
R8526.....	208	R8806.....	135	R8879.....	182	R8952.....	181	R8995.....	153
R8527.....	208	R8807.....	135	R8880.....	182	R8953.....	181	R8995SM.....	154
R8530.....	208	R8808.....	135	R8881.....	182	R8954.....	180	R8996.....	153
R8535.....	207	R8809.....	135	R8882.....	182	R8955.....	180	R8996SM.....	154
R8536.....	207	R8810.....	135	R8883.....	182	R8956.....	181	R8997.....	153
R8537.....	207	R8811.....	135	R8884.....	182	R8957.....	22, 181	R8997SM.....	154
R8538.....	207	R8812.....	135	R8885.....	182	R8958.....	181	R8998.....	50
R8645.....	206	R8813.....	135	R8886.....	182	R8959.....	50	R8999.....	50
R8646.....	206	R8814.....	135	R8887.....	182	R8960.....	50	R9000.....	153
R8647.....	206	R8815.....	135	R8888.....	182	R8961.....	50	R9000SM.....	154
R8658.....	206	R8817.....	135	R8889.....	182	R8962.....	50	R9001.....	153
R8659.....	206	R8818.....	135	R8890.....	182	R8963.....	50	R9001SM.....	154
R8763.....	136	R8819.....	135	R8891.....	182	R8964.....	50	R9002.....	153
R8764.....	136	R8820.....	135	R8906.....	22, 183	R8965.....	153	R9002SM.....	154
R8765.....	136	R8821.....	135	R8907.....	22, 183	R8966.....	153	R9003.....	153
R8766.....	136	R8822.....	135	R8908.....	22, 183	R8967.....	153	R9004.....	153
R8767.....	136	R8823.....	135	R8909.....	22, 183	R8968.....	153	R9005.....	153
R8768.....	136	R8824.....	135	R8911.....	23, 183	R8969.....	153	R9006.....	153
R8770.....	136	R8825.....	135	R8912.....	23, 183	R8970.....	153	R9007.....	153
R8771.....	136	R8826.....	135	R8913.....	22	R8974.....	77	R9007SM.....	154
R8772.....	136	R8827.....	135	R8914.....	22	R8975.....	77	R9008.....	153
R8773.....	136	R8828.....	135	R8915.....	22	R8977.....	180, 181, 222	R9008SM.....	154
R8774.....	136	R8829.....	135	R8921.....	77	R8978.....	77	R9009.....	153
R8775.....	136	R8830.....	135	R8922.....	77	R8979.....	50	R9009SM.....	154
R8776.....	136	R8831.....	135	R8923.....	77	R8980.....	153	R9010.....	153
R8777.....	136	R8832.....	135	R8924.....	201	R8980SM.....	154	R9012SM.....	154
R8778.....	136	R8833.....	135	R8925.....	201	R8981.....	153	R9013SM.....	154
R8779.....	136	R8834.....	135	R8926.....	201	R8981SM.....	154	R9014SM.....	154
R8780.....	136	R8835.....	135	R8927.....	201	R8982.....	153	R9015SM.....	154
R8781.....	136	R8836.....	135	R8928.....	201	R8982SM.....	154	R9016SM.....	154
R8782.....	136	R8850.....	206	R8929.....	201	R8983.....	153	R9017SM.....	154
R8783.....	136	R8851.....	206	R8930.....	201	R8983SM.....	154	R9018SM.....	154
R8784.....	136	R8852.....	206	R8931.....	201	R8984.....	153	R9019SM.....	154
R8785.....	136	R8855.....	206	R8931S.....	201	R8984SM.....	154	R9020SM.....	154
R8786.....	136	R8856.....	206	R8932.....	201	R8985.....	153	R9021SM.....	154
R8787.....	136	R8857.....	206	R8933.....	201	R8985SM.....	154	R9042.....	153
R8788.....	136	R8858.....	206	R8934.....	201	R8986.....	153	R9042SM.....	154
R8789.....	136	R8860.....	206	R8935.....	180	R8986SM.....	154	R9043.....	153
R8790.....	136	R8861.....	206	R8936.....	180	R8987.....	153	R9043SM.....	154
R8791.....	136	R8862.....	206	R8937.....	180	R8987SM.....	154	R9044.....	153
R8792.....	136	R8865.....	209	R8938.....	180	R8988.....	153	R9044SM.....	154
R8793.....	136	R8866.....	209	R8939.....	180	R8988SM.....	154	R9045.....	153
R8794.....	136	R8867.....	209	R8940.....	180	R8989.....	153	R9045SM.....	154
R8795.....	136	R8868.....	209	R8941.....	180	R8989SM.....	154	R9046.....	153
R8796.....	136	R8869.....	209	R8942.....	180	R8990.....	153	R9046SM.....	154

R9047.....	153	RB41114.....	109	RB4625.....	109	RB4724M.....	105	RB4823X.....	113
R9047SM.....	154	RB41115.....	109	RB4625X.....	113	RB4724X.....	113	RB4824.....	109
R9100.....	75	RB41116.....	109	RB4626.....	109	RB4725.....	109	RB4824M.....	105
R9101.....	76	RB41122.....	109	RB4626X.....	113	RB4725M.....	105	RB4824X.....	113
R9102.....	76	RB41123.....	109	RB4632.....	102	RB4725X.....	113	RB4825.....	109
R9103.....	76	RB41124.....	109	RB4633.....	102	RB4726.....	109	RB4825M.....	105
R9104.....	76	RB41125.....	109	RB4634.....	102	RB4726M.....	105	RB4825X.....	113
R9105.....	76, 218	RB41126.....	109	RB4635.....	102	RB4726X.....	113	RB4826.....	109
R9106.....	76	RB41132.....	102	RB4636.....	102	RB4732.....	102	RB4826M.....	105
R9395.....	33	RB41133.....	102	RB4642.....	102	RB4733.....	102	RB4826X.....	113
RB41002.....	109	RB41134.....	102	RB4643.....	102	RB4734.....	102	RB4833.....	102
RB41003.....	109	RB41135.....	102	RB4644.....	102	RB4735.....	102	RB4834.....	102
RB41004.....	109	RB41136.....	102	RB4645.....	102	RB4736.....	102	RB4835.....	102
RB41005.....	109	RB41142.....	102	RB4646.....	102	RB4742.....	102	RB4836.....	102
RB41006.....	109	RB41143.....	102	RB4652.....	102	RB4743.....	102	RB4843.....	102
RB41012.....	109	RB41144.....	102	RB4653.....	102	RB4744.....	102	RB4844.....	102
RB41013.....	109	RB41145.....	102	RB4654.....	102	RB4745.....	102	RB4845.....	102
RB41014.....	109	RB41146.....	102	RB4655.....	102	RB4746.....	102	RB4846.....	102
RB41015.....	109	RB41151.....	102	RB4656.....	102	RB4751.....	102	RB4851.....	102
RB41016.....	109	RB41152.....	102	RB4662.....	102	RB4751M.....	105	RB4851M.....	105
RB41022.....	109	RB41153.....	102	RB4663.....	102	RB4752.....	102	RB4853.....	102
RB41023.....	109	RB41154.....	102	RB4664.....	102	RB4753.....	102	RB4854.....	102
RB41024.....	109	RB41155.....	102	RB4665.....	102	RB4754.....	102	RB4855.....	102
RB41025.....	109	RB41156.....	102	RB4666.....	102	RB4755.....	102	RB4856.....	102
RB41026.....	109	RB41162.....	102	RB4702.....	109	RB4756.....	102	RB4860.....	102
RB41032.....	102	RB41163.....	102	RB4703.....	109	RB4760.....	102	RB4861.....	102
RB41033.....	102	RB41164.....	102	RB4703X.....	113	RB4761.....	102	RB4862.....	102
RB41034.....	102	RB41165.....	102	RB4704.....	109	RB4763.....	102	RB4863.....	102
RB41035.....	102	RB41166.....	102	RB4704X.....	113	RB4764.....	102	RB4864.....	102
RB41036.....	102	RB41191.....	102	RB4705.....	109	RB4765.....	102	RB4865.....	102
RB41042.....	102	RB4602.....	109	RB4705X.....	113	RB4766.....	102	RB4866.....	102
RB41043.....	102	RB4603.....	109	RB4706.....	109	RB4771.....	102	RB4872.....	102
RB41044.....	102	RB4603X.....	113	RB4706X.....	113	RB4772.....	102	RB4872D.....	120
RB41045.....	102	RB4604.....	109	RB4712.....	109	RB4790.....	102	RB4873D.....	120
RB41046.....	102	RB4604X.....	113	RB4713.....	109	RB4802.....	109	RB4874D.....	120
RB41051.....	102	RB4605.....	109	RB4713X.....	113	RB4803.....	109	RB4875D.....	120
RB41052.....	102	RB4605X.....	113	RB4714.....	109	RB4804.....	109	RB4882.....	102
RB41053.....	102	RB4606.....	109	RB4714X.....	113	RB4805.....	109	RB4890.....	102
RB41054.....	102	RB4606X.....	113	RB4715.....	109	RB4806.....	109	RB4891.....	102
RB41055.....	102	RB4612.....	109	RB4715X.....	113	RB4812.....	109	RB4892.....	102
RB41056.....	102	RB4613.....	109	RB4716.....	109	RB4813.....	109	RB4892E.....	118
RB41062.....	102	RB4613X.....	113	RB4716X.....	113	RB4813X.....	113	RB4893.....	118
RB41063.....	102	RB4614.....	109	RB4717.....	116	RB4814.....	109	RB4894.....	118
RB41064.....	102	RB4614X.....	113	RB4718.....	116	RB4814X.....	113	RB4895.....	118
RB41065.....	102	RB4615.....	109	RB4719.....	116	RB4815.....	109	RB4896.....	118
RB41066.....	102	RB4615X.....	113	RB4720.....	116	RB4815X.....	113	RB4902.....	109
RB41091.....	102	RB4616.....	109	RB4721.....	116	RB4816.....	109	RB4903.....	109
RB41102.....	109	RB4616X.....	113	RB4721M.....	105	RB4816X.....	113	RB4904.....	109
RB41103.....	109	RB4622.....	109	RB4722.....	109	RB4821M.....	105	RB4905.....	109
RB41104.....	109	RB4622X.....	113	RB4722M.....	105	RB4822.....	109	RB4906.....	109
RB41105.....	109	RB4623.....	109	RB4722X.....	113	RB4822M.....	105	RB4912.....	109
RB41106.....	109	RB4623X.....	113	RB4723.....	109	RB4822X.....	113	RB4913.....	109
RB41112.....	109	RB4624.....	109	RB4723M.....	105	RB4823.....	109	RB4914.....	109
RB41113.....	109	RB4624X.....	113	RB4723X.....	113	RB4823M.....	105	RB4915.....	109

RB4916.....	109	RD4853	103	RN01200	123	RN0211.....	13	RN0887	138
RB4922.....	109	RD4854	103	RN01201	123	RN0222	17	RN0888	138
RB4922X.....	113	RD4855	103	RN01202	123	RN0326	212, 214	RN0897	138
RB4923.....	109	RD4856	103	RN01203	123	RN0330	213, 214	RN0898	138
RB4924.....	109	RD4882	103	RN01204	123	RN0331	213, 214	RN0899	138
RB4925.....	109	RD4891	103	RN01205	123	RN0332	213, 214	RN0900	123
RB4926.....	109	RE0800.....	123	RN01206	123	RN0335	21	RN0900TS.....	123
RB4932.....	102	RE0800T	123	RN01207	123	RN0401	16	RN0901	123
RB4933.....	102	RE0801.....	123	RN01208	123	RN0402	16	RN0902	123
RB4934.....	102	RE0802.....	123	RN01209	123	RN0403	16	RN0903	123
RB4935.....	102	RE0803.....	123	RN0121	9	RN0404	16	RN0904	123
RB4936.....	102	RE0804.....	123	RN01210	123	RN0405	16	RN0905	123
RB4942.....	102	RE0805.....	123	RN01220	124	RN0410	15	RN0906	123
RB4943.....	102	RE0806.....	123	RN01221	124	RN0413	17	RN0907	123
RB4944.....	102	RE0807.....	123	RN01222	124	RN0506	19	RN0908	123
RB4945.....	102	RE0808.....	123	RN01223	124	RN0600	123	RN0909	123
RB4946.....	102	RE0809.....	123	RN01224	124	RN06001	123	RN0910	123
RB4951.....	102	RE0810.....	123	RN01225	124	RN0601	123	RN0920	124
RB4952.....	102	RE0820.....	124	RN01226	124	RN0602	123	RN0920TS.....	124
RB4953.....	102	RE0820T	124	RN01227	124	RN0603	123	RN0921	124
RB4954.....	102	RE0821.....	124	RN01228	124	RN0604	123	RN0922	124
RB4955.....	102	RE0822.....	124	RN01229	124	RN0605	123	RN0923	124
RB4956.....	102	RE0823.....	124	RN0123	11	RN0606	123	RN0924	124
RB4962.....	102	RE0824.....	124	RN01230	124	RN0607	123	RN0925	124
RB4963.....	102	RE0825.....	124	RN0124	11	RN0608	123	RN0926	124
RB4964.....	102	RE0826.....	124	RN01248	125	RN0609	123	RN0927	124
RB4965.....	102	RE0827.....	124	RN01249	125	RN0700	49	RN0928	124
RB4966.....	102	RE0828.....	124	RN01250	125	RN0701	49	RN0929	124
RB4991.....	102	RE0829.....	124	RN01251	125	RN0702	49	RN0930	124
RD4722	110	RE0830.....	124	RN01252	125	RN0703	49	RN0945	141
RD4723	110	RE0848.....	125	RN01253	125	RN0704	49	RN0946	141
RD4724	110	RE0848T	125	RN01254	125	RN0705	49	RN0947	141
RD4725	110	RE0849.....	125	RN01255	125	RN0706	49	RN0948	125
RD4726	110	RE0850.....	125	RN01256	125	RN0707	49	RN0948TS.....	125
RD4751	103	RE0851.....	125	RN01257	125	RN0710	48	RN0949	125
RD4752	103	RE0852.....	125	RN01258	125	RN0711.....	48	RN0950	125
RD4753	103	RE0853.....	125	RN0127	188	RN0711N.....	48	RN0951	125
RD4754	103	RE0854.....	125	RN0128	11	RN0711W.....	48	RN0952	125
RD4755	103	RE0855.....	125	RN0140	30	RN0712	48	RN0953	125
RD4756	103	RE0856.....	125	RN0141	162	RN0712N.....	48	RN0954	125
RD4771	103	RE0857.....	125	RN0142	162	RN0712W.....	48	RN0955	125
RD4821M	106	RE0858.....	125	RN0143	162	RN0713	48	RN0956	125
RD4822	110	RG2020.....	171	RN0144	162	RN0713N.....	48	RN0957	125
RD4822M	106	RN0061	7	RN0145	162	RN0713W.....	48	RN0958	125
RD4823	110	RN0062	7	RN0162	165	RN0714	48	RN0960	129
RD4823M	106	RN0070	7	RN0163	165	RN0714N.....	48	RN0961	129
RD4824	110	RN0071	7	RN0168	167	RN0714W.....	48	RN0962	129
RD4824M	106	RN0072	7	RN0171	165	RN0820	141	RN0981	138
RD4825	110	RN0073	7	RN0173	165	RN0821	141	RN0982	138
RD4825M	106	RN0074	6	RN0176	161	RN0822	141	RN0983	138
RD4826	110	RN0075	6	RN0178	165	RN0881	138	RN0986	138
RD4826M	106	RN0076	6	RN0188	191	RN0882	138	RN0987	138
RD4851	103	RN0077	6	RN0189	191	RN0883	138, 214	RN0988	138
RD4851M	106	RN0120	9	RN0210	13	RN0886	138	RN0991	140

RN0992 140	RN2504 61	RN28122 46	RN3025 84	RN41116..... 108
RN0993 140	RN2506 61	RN28123 46	RN3026 84	RN41122..... 108
RN0994 140	RN2528 67	RN28124 46	RN3030 88	RN41123..... 108
RN0995 140	RN2536 68	RN28125 46	RN3031 88	RN41124..... 108
RN0996 140	RN2540 65	RN28126 46	RN3032 88	RN41125..... 108
RN1120..... 197	RN2575 207	RN28127 46	RN3033 88	RN41126..... 108
RN1121..... 197	RN2576 207	RN28210 46	RN3034 88	RN41132..... 101
RN1122..... 197	RN2577 207	RN28211..... 46	RN3035 88	RN41133..... 101
RN1123..... 197	RN2578 207	RN28212 46	RN41002 108	RN41134..... 101
RN1124..... 197	RN2614 65	RN28213 46	RN41003 108	RN41135..... 101
RN1125..... 197	RN2673 57	RN28214 46	RN41004 108	RN41136..... 101
RN1126..... 197	RN2688 58	RN28215 46	RN41005 108	RN41142..... 101
RN1127..... 197	RN2689 58	RN28216 46	RN41006 108	RN41143..... 101
RN1127N..... 197	RN2701 68	RN28217 46	RN41012 108	RN41144..... 101
RN1128..... 197	RN2702 68	RN28218 46	RN41013 108	RN41145..... 101
RN1128N..... 197	RN2703 68	RN28219 46	RN41014 108	RN41146..... 101
RN1129..... 197	RN2704 68	RN28220 46	RN41015 108	RN41151..... 101
RN1129N..... 197	RN2705 68	RN28221 46	RN41016 108	RN41152..... 101
RN1170..... 132	RN2706 68	RN28222 46	RN41022 108	RN41153..... 101
RN1171..... 132	RN2707 68	RN28223 46	RN41023 108	RN41154..... 101
RN1172..... 132	RN2708 68	RN28224 46	RN41024 108	RN41155..... 101
RN1173..... 132	RN2709 68	RN28225 46	RN41025 108	RN41156..... 101
RN1180..... 132	RN2710 68	RN28226 46	RN41026 108	RN41162..... 101
RN1181..... 132	RN2711..... 68	RN28227 46	RN41032 101	RN41163..... 101
RN1182..... 132	RN2712 68	RN28310 46	RN41033 101	RN41164..... 101
RN1183..... 132	RN2720 62	RN28311..... 46	RN41034 101	RN41165..... 101
RN2015 59	RN2721 62	RN28312 46	RN41035 101	RN41166..... 101
RN2102 51	RN2722 62	RN28313 46	RN41036 101	RN41191..... 101
RN2104 52	RN27225 62	RN28314 46	RN41042 101	RN4602 108
RN2105 52	RN2723 62	RN28315 46	RN41043 101	RN4603 108
RN2210 53, 154	RN27235 62	RN28316 46	RN41044 101	RN4603X 112
RN2211 53, 154	RN2724 62	RN28317 46	RN41045 101	RN4604 108
RN2212 53, 154	RN27245 62	RN28318 46	RN41046 101	RN4604X 112
RN2213 53, 154	RN2725 63	RN28319 46	RN41051 101	RN4605 108
RN2300 55	RN2726 63	RN28320 46	RN41052 101	RN4605X 112
RN2301 55	RN2727 63	RN28321 46	RN41053 101	RN4606 108
RN2302 55	RN2728 63	RN28322 46	RN41054 101	RN4606X 112
RN2320 56	RN2729 63	RN28323 46	RN41055 101	RN4612 108
RN2321 56	RN2800 45	RN28324 46	RN41056 101	RN4613 108
RN2322 56	RN2801 45	RN28325 46	RN41062 101	RN4613X 112
RN2323 56	RN2802 45	RN28326 46	RN41063 101	RN4614 108
RN2400 60	RN2803 45	RN28327 46	RN41064 101	RN4614X 112
RN2401 60	RN28110..... 46	RN28410 46	RN41065 101	RN4615 108
RN2402 60	RN28111..... 46	RN28411..... 46	RN41066 101	RN4615X 112
RN2403 60	RN28112..... 46	RN28412 46	RN41091 101	RN4616 108
RN2404 60	RN28113..... 46	RN28413 46	RN41102..... 108	RN4616X 112
RN2405 60	RN28114..... 46	RN28414 46	RN41103..... 108	RN4622 108
RN2406 60	RN28115..... 46	RN28415 46	RN41104..... 108	RN4622X 112
RN2407 60	RN28116..... 46	RN2877 34	RN41105..... 108	RN4623 108
RN2408 60	RN28117..... 46	RN2878 34	RN41106..... 108	RN4623X 112
RN2409 60	RN28118..... 46	RN2879 34	RN41112 108	RN4624 108
RN2501 61	RN28119..... 46	RN3022 84	RN41113 108	RN4624X 112
RN2502 61	RN28120 46	RN3023 84	RN41114 108	RN4625 108
RN2503 61	RN28121 46	RN3024 84	RN41115 108	RN4625X 112

RUGGLES™ Numerical Index

RN4626 108	RN4725 108	RN4822 108	RN4906 108	RN5424 212, 214
RN4626X 112	RN4725M 104	RN4822M 104	RN4912 108	RN5512H 90
RN4632 101	RN4725X 112	RN4822X 112	RN4913 108	RN5522H 90
RN4633 101	RN4726 108	RN4823 108	RN4914 108	RN5526 95
RN4634 101	RN4726M 104	RN4823M 104	RN4915 108	RN5527 95
RN4635 101	RN4726X 112	RN4823X 112	RN4916 108	RN5528 95
RN4636 101	RN4732 101	RN4824 108	RN4922 108	RN5532H 90
RN4642 101	RN4733 101	RN4824M 104	RN4922X 112	RN5543H 91
RN4643 101	RN4734 101	RN4824X 112	RN4923 108	RN5544H 93
RN4644 101	RN4735 101	RN4825 108	RN4924 108	RN5553H 91
RN4645 101	RN4736 101	RN4825M 104	RN4925 108	RN5554H 93
RN4646 101	RN4737 115	RN4825X 112	RN4926 108	RN5563H 91
RN4652 101	RN4739 115	RN4826 108	RN4932 101	RN5564H 93
RN4653 101	RN4742 101	RN4826M 104	RN4933 101	RN5603 96
RN4654 101	RN4743 101	RN4826X 112	RN4934 101	RN5604 96
RN4655 101	RN4744 101	RN4833 101	RN4935 101	RN5605 96
RN4656 101	RN4745 101	RN4834 101	RN4936 101	RN5612H 90
RN4662 101	RN4746 101	RN4835 101	RN4943 101	RN5622H 90
RN4663 101	RN4751 101	RN4836 101	RN4944 101	RN5622X 90
RN4664 101	RN4751M 104	RN4843 101	RN4945 101	RN5632H 90
RN4665 101	RN4752 101	RN4844 101	RN4946 101	RN5643H 91
RN4666 101	RN4753 101	RN4845 101	RN4951 101	RN5644H 93
RN4702 108	RN4754 101	RN4846 101	RN4952 101	RN5653H 91
RN4703 108	RN4755 101	RN4851 101	RN4953 101	RN5654H 93
RN4703X 112	RN4756 101	RN4851M 104	RN4954 101	RN5663H 91
RN4704 108	RN4760 101	RN4853 101	RN4955 101	RN5664H 93
RN4704X 112	RN4761 101	RN4854 101	RN4956 101	RN5680 90
RN4705 108	RN4763 101	RN4855 101	RN4962 101	RN5681 90
RN4705X 112	RN4764 101	RN4856 101	RN4963 101	RN5682 90
RN4706 108	RN4765 101	RN4860 101	RN4964 101	RN5703 96
RN4706X 112	RN4766 101	RN4861 101	RN4965 101	RN5704 96
RN4712 108	RN4771 101	RN4862 101	RN4966 101	RN5705 96
RN4713 108	RN4772 101	RN4863 101	RN4972 101	RN5712 90
RN4713X 112	RN4790 101	RN4864 101	RN4991 101	RN5712H 90, 214
RN4714 108	RN4802 108	RN4865 101	RN5000 214	RN5712X 90
RN4714X 112	RN4803 108	RN4866 101	RN51112H 90	RN5722 90
RN4715 108	RN4803X 112	RN4872 101, 214	RN51122H 90	RN5722H 90, 214
RN4715X 112	RN4804 108	RN4872D 120	RN51132H 90	RN5722X 90
RN4716 108	RN4804X 112	RN4873D 120	RN51143H 91	RN5732 90
RN4716X 112	RN4805 108	RN4874D 120	RN51144H 93	RN5732H 90
RN4717 115	RN4805X 112	RN4875D 120	RN51153H 91	RN5732X 90
RN4718 115	RN4806 108	RN4882 101, 214	RN51154H 93	RN5743 91
RN4719 115	RN4806X 112	RN4890 101	RN51163H 91	RN5743H 91
RN4720 115	RN4812 108	RN4891 101, 214	RN51164H 93	RN5743HX 91
RN4721M 104	RN4813 108	RN4892 101	RN51212H 90	RN5743X 91
RN4722 108	RN4813X 112	RN4892E 118	RN51222H 90	RN5744 93
RN4722M 104	RN4814 108	RN4893 118	RN51232H 90	RN5744H 93
RN4722X 112	RN4814X 112	RN4894 118	RN51243H 91	RN5744X 93
RN4723 108	RN4815 108	RN4895 118	RN51244H 93	RN5753 91
RN4723M 104	RN4815X 112	RN4896 118	RN51253H 91	RN5753H 91
RN4723X 112	RN4816 108	RN4902 108	RN51254H 93	RN5753HX 91
RN4724 108	RN4816X 112	RN4903 108	RN51263H 91	RN5753X 91
RN4724M 104	RN4819 115	RN4904 108	RN51264H 93	RN5754 93
RN4724X 112	RN4821M 104	RN4905 108	RN5423 212, 214	RN5754H 93

RN5754X.....93	RN6213.....176	RN6614.....178	RN8008B.....200	RN82525.....151, 214
RN5763.....91	RN6214.....176	RN6615.....178	RN8009.....200	RN82527.....151, 214
RN5763H.....91	RN6215.....176	RN6616.....178	RN8009B.....200	RN8253.....153
RN5763HX.....91	RN6216.....176	RN6617.....178	RN8020.....199	RN8254.....153
RN5763X.....91	RN6217.....176	RN6626.....179	RN8021.....199	RN8255.....153
RN5764.....93	RN6218.....176	RN6700.....177	RN8022.....199	RN8256.....153
RN5764H.....93	RN6219.....176	RN6701.....177	RN8023.....199	RN8257.....153
RN5764X.....93	RN6220.....223	RN6702.....177	RN8025.....204	RN8258.....153
RN5780.....90, 214	RN6225.....175	RN6703.....177	RN8026.....204	RN8259.....153
RN5781.....90	RN6230.....175	RN6704.....177	RN8028.....168	RN82610.....153
RN5782.....90	RN6240.....198	RN6705.....177	RN8029.....168	RN82612.....153
RN5802.....99	RN6241.....198	RN6706.....177	RN8030.....168	RN82625.....151, 214
RN5803.....99	RN6253.....199	RN6707.....177	RN8031.....168	RN82627.....151, 214
RN5804.....99	RN6254.....199	RN6708.....177	RN8032.....168	RN8263.....153
RN5805.....99	RN6255.....199	RN6709.....177	RN8033.....168	RN8264.....153
RN5806.....99	RN6256.....199	RN6710.....177	RN8034.....168	RN8265.....153
RN5808.....99	RN6271.....204	RN6711.....177	RN8036.....168	RN8266.....153
RN5812.....99	RN6272.....204	RN6712.....177	RN8060.....198	RN8267.....153
RN5813.....99	RN6273.....204	RN6713.....177	RN8061.....198	RN8268.....153
RN5814.....99	RN6274.....204	RN6714.....177	RN8065.....199	RN8269.....153
RN5816.....99	RN6300.....210	RN6715.....177	RN8066.....199	RN82725.....151, 214
RN5822.....99	RN6301.....210, 214	RN6716.....177	RN8111.....190	RN82727.....151, 214
RN5823.....99	RN6302.....210, 214	RN6717.....177	RN8112.....190	RN8275.....203
RN5824.....99	RN6303.....210, 214	RN7021.....213, 214	RN8113.....190	RN8276.....203
RN5826.....99	RN6304.....210, 214	RN7022.....213, 214	RN8114.....190	RN82810.....153
RN5903.....96	RN6305.....210	RN7023.....213, 214	RN8121.....188	RN82812.....153
RN5904.....96	RN6306.....210	RN7061.....213, 214	RN8122.....188	RN8283.....153
RN5905.....96	RN6307.....210, 214	RN7127.....99	RN8123.....188	RN8284.....153
RN5912H.....90	RN6308.....210, 214	RN7128.....99	RN8124.....188	RN8285.....153
RN5922H.....90	RN6309.....211	RN7129.....99	RN8125.....188	RN8286.....153
RN5932H.....90	RN6310.....211	RN7130.....99	RN8126.....188	RN8287.....153
RN5943H.....91	RN6311.....211	RN7131.....99, 212, 214	RN8127.....188	RN8288.....153
RN5944H.....93	RN6312.....211	RN7132.....98	RN8128.....188	RN8289.....153
RN5953H.....91	RN6313.....211	RN7214.....30, 158	RN8136.....203	RN8294.....191
RN5954H.....93	RN6314.....211	RN7217.....30, 158	RN8137.....203	RN8295.....191
RN5963H.....91	RN6315.....211	RN7218.....30, 158	RN8138.....167	RN8297.....203
RN5964H.....93	RN6316.....211	RN7219.....30, 158	RN8139.....167	RN8298.....203
RN5980.....90	RN6320.....210, 226	RN8000.....200	RN8140.....167	RN8299.....203
RN5981.....90	RN6323.....210, 214	RN8000B.....200	RN8141.....167	RN8503.....146
RN5982.....90	RN6324.....210, 214	RN8001.....200	RN8142.....198	RN8504.....146
RN6021.....212, 214	RN6600.....178	RN8001B.....200	RN8143.....198	RN8505.....146
RN6200.....175	RN6601.....178	RN8002.....200	RN8144.....198	RN8506.....146
RN6201.....176	RN6602.....178	RN8002B.....200	RN8145.....199	RN8507.....146
RN6202.....176	RN6603.....178	RN8003.....200	RN8146.....199	RN8508.....146
RN6203.....176	RN6604.....178	RN8003B.....200	RN8147.....199	RN8509.....146
RN6204.....176	RN6605.....178	RN8004.....200	RN8148.....199	RN8510.....146
RN6205.....176	RN6606.....178	RN8004B.....200	RN8149.....199	RN8511.....146
RN6206.....176	RN6607.....178	RN8005.....200	RN82325.....151, 214	RN8512.....146
RN6207.....176	RN6608.....178	RN8005B.....200	RN82327.....151, 214	RN85210.....146
RN6208.....176	RN6609.....178	RN8006.....200	RN82425.....151, 214	RN85211.....146
RN6209.....176	RN6610.....178	RN8006B.....200	RN82427.....151, 214	RN85212.....146
RN6210.....176	RN6611.....178	RN8007.....200	RN82510.....153	RN8523.....146
RN6211.....176	RN6612.....178	RN8007B.....200	RN82512.....153	RN8524.....146
RN6212.....176	RN6613.....178	RN8008.....200	RN825211.....151, 214	RN8525.....146

RUGGLES™ Numerical Index

RN8526 146	RN8768 145	RR2206 193	RR2806 196	RU2431 44
RN8527 146	RN8769 145	RR2207 193	RR2807 196	RU2432 44
RN8528 146	RN87810 145	RR2208 193	RR2808 196	RU2433 44
RN8529 146	RN87811 145	RR2209 193	RR2809 196	RU2434 44
RN85610 145	RN87812 145	RR2301 193	RR2810 196	RU2435 44
RN85611 145	RN8783 145	RR2302 193	RR2811 196	RU2436 44
RN85612 145	RN8784 145	RR2303 193	RR2812 196	RU2437 44
RN8563 145	RN8785 145	RR2304 193	RR5712X 90	RU2438 44
RN8564 145	RN8786 145	RR2305 193	RR5722X 90	RU2439 44
RN8565 145	RN8787 145	RR2306 193	RS0900.. 124, 128, 219	RU2446 44
RN8566 145	RN8788 145	RR2307 193	RS1120 197, 225	RU2447 44
RN8567 145	RN8789 145	RR2308 193	RS2400 43, 219	RU2448 44
RN8568 145	RN9000L 152	RR2309 193	RS2800 45, 219	RU2449 44
RN8569 145	RN9000R 152	RR2401 193	RS5000 214, 226	RU2450 44
RN85810 145	RN9000T 152	RR2402 193	RS6215 224	RU2451 44
RN85811 145	RN9001L 152	RR2403 193	RS6219 223	RU2452 44
RN85812 145	RN9001R 152	RR2404 193	RS6600.. 178, 223, 224	RU2453 44
RN8583 145	RN9001T 152	RR2405 193	RS6700 177, 224	RU2454 44
RN8584 145	RN9002L 152	RR2406 193	RS8000 200, 225	RU2455 44
RN8585 145	RN9002R 152	RR2407 193	RT0145 163	RU2456 44
RN8586 145	RN9002T 152	RR2408 193	RT0146 163	RU2457 44
RN8587 145	RN9003L 152	RR2409 193	RT0150 159	RU2464 44
RN8588 145	RN9003R 152	RR2501 194	RT0154 159	RU2465 44
RN8589 145	RN9003T 152	RR2502 194	RT0155 159	RU2466 44
RN8612 150	RN9103 149	RR2503 194	RT0156 159	RU2467 44
RN8615 150	RN9105 149	RR2504 194	RT0157 159	RU2468 44
RN8703 146	RN9107 149	RR2505 194	RT0158 159	RU2469 44
RN8704 146	RN9110 149	RR2506 194	RT0165 162	
RN8705 146	RN9112 149	RR2507 194	RT0172 161	
RN8706 146	RN9203 149	RR2508 194	RT0173 165	
RN8707 146	RN9205 149	RR2509 194	RU2400 43	
RN8708 146	RN9207 149	RR2601 194	RU2403 44	
RN8709 146	RN9210 149	RR2602 194	RU2404 44	
RN8710 146	RN9212 149	RR2603 194	RU2405 44	
RN8711 146	RN9303 149	RR2604 194	RU2406 44	
RN8712 146	RN9305 149	RR2605 194	RU2407 44	
RN87210 146	RN9307 149	RR2606 194	RU2408 43	
RN87211 146	RN9310 149	RR2607 194	RU2409 43	
RN87212 146	RN9312 149	RR2608 194	RU2410 44	
RN8723 146	RN9405 149	RR2609 194	RU2411 44	
RN8724 146	RN9407 149	RR2701 195	RU2412 44	
RN8725 146	RN9410 149	RR2702 195	RU2413 44	
RN8726 146	RN9505 149	RR2703 195	RU2414 44	
RN8727 146	RN9507 149	RR2704 195	RU2415 44	
RN8728 146	RN9510 149	RR2705 195	RU2416 44	
RN8729 146	RN9625 150	RR2706 195	RU2417 44	
RN87610 145	RN9627 150	RR2707 195	RU2418 44	
RN87611 145	RN9725 150	RR2708 195	RU2419 44	
RN87612 145	RN9727 150	RR2709 195	RU2420 44	
RN8763 145	RR2201 193	RR2710 195	RU2421 44	
RN8764 145	RR2202 193	RR2711 195	RU2422 43	
RN8765 145	RR2203 193	RR2712 195	RU2428 44	
RN8766 145	RR2204 193	RR2804 196	RU2429 44	
RN8767 145	RR2205 193	RR2805 196	RU2430 44	

Alphabetical Index

Apfelbaum Bipolar Forceps	197
Apfelbaum Bipolar Forceps Tray.....	197, 225
RUGGLES Sterile Distraction Screws.....	34

Numerical Index

R6367A.....	34
R6398A.....	34
R6397A.....	34
RN1121.....	197
RN1122.....	197
RN1123.....	197
RN1124.....	197
RN1125.....	197
RN1126.....	197
RN1127.....	197
RN1127N.....	197
RN1128.....	197
RN1128N.....	197
RN1129.....	197
RN1129N.....	197
RS1120.....	197, 225

Conversion Scale

To Convert From	To	Multiply By
Ounces (AVDP.)	Grams	28.349523
Ounces (APOTH.)	Grams	31.103486
Grains	Grams	0.06479891
Pounds (AVDP.)	Kilograms	0.45359237
Inches	Centimeters	2.54
Feet	Meters	0.3048
Yards	Meters	0.9144
Ounces (U.S. Fluid)	Cubic Centimeters	29.573730
Ounces (British Fluid)	Cubic Centimeters	28.41305
Quarts (U.S. Fluid)	Liters	0.9463264
Cubic Inches	Cubic Centimeters	16.387064
Grams	Grains	15.432358
Grams	Ounces (AVDP.)	0.35273962
Grams	Ounces (APOTH.)	0.32150737
Kilograms	Pounds (AVDP.)	2.2046226
Millimeters	Inches	0.039370079
Centimeters	Inches	0.39370079
Meters	Feet	3.2808399
Cubic Centimeters	Cubic Inches	0.61023744
Cubic Centimeters (Fluid)	Ounces (U.S. Fluid)	0.33814023
Liters	Quarts (U.S. Fluid)	1.056718

Comparative Scales

Used in measuring the diameters of Catheters, Sounds and Bougies

DIAMETERS IN MILLIMETERS				DIAMETERS IN MILLIMETERS			
	AMERICAN	FRENCH	ENGLISH		AMERICAN	FRENCH	ENGLISH
1/3	---	1	---	7	14	21	---
1/2	1	---	---	7 1/3	---	22	12
2/3	---	2	---	7 1/2	15	---	---
1	2	3	---	7 2/3	---	23	13
1 1/3	---	4	---	8	16	24	---
1 1/2	3	---	---	8 1/3	---	25	14
1 2/3	---	5	---	8 1/2	17	---	---
2	4	6	---	8 2/3	---	26	15
2 1/3	---	7	1	9	18	27	16
2 1/2	5	---	---	9 1/3	---	28	17
2 2/3	---	8	2	9 1/2	19	---	---
3	6	9	3	9 2/3	---	29	---
3 1/3	---	10	---	10	20	30	18
3 1/2	7	---	---	10 1/3	---	31	19
3 2/3	---	11	4	10 1/2	21	---	---
4	8	12	5	10 2/3	---	32	20
4 1/3	---	13	---	11	22	33	21
4 1/2	9	---	---	11 1/3	---	34	22
4 2/3	---	14	---	11 1/2	23	---	---
5	10	15	6	11 2/3	---	35	23
5 1/3	---	16	7	12	24	36	24
5 1/2	11	---	---	12 1/3	---	37	25
5 2/3	---	17	8	12 1/2	25	---	---
6	12	18	9	12 2/3	---	38	26
6 1/3	---	19	10	13	26	39	27
6 1/2	13	---	---	13 1/3	---	40	28
6 2/3	---	20	11				

French Catheter Scale

MM	INCH		FR	MM	INCH		FR
1	.039	◦	3	5.7	.223	○	17
1.35	.053	◦	4	6.0	.236	○	18
1.67	.066	◦	5	6.3	.249	○	19
2.0	.079	○	6	6.7	.263	○	20
2.3	.092	○	7	7.3	.288	○	22
2.7	.105	○	8	8.0	.315	○	24
3.0	.118	○	9	8.7	.341	○	26
3.3	.131	○	10	9.3	.367	○	28
3.7	.144	○	11	10.0	.393	○	30
4.0	.158	○	12	10.7	.419	○	32
4.3	.170	○	13	11.3	.445	○	34

Fahrenheit and Centigrade Scales

F.	C.
500	260
401	205
392	200
383	195
374	190
356	180
347	175
338	170
329	165
320	160
311	155
302	150
284	140
275	135
266	130
248	120
239	115
230	110
212	100
203	95
194	90
176	80
167	75
140	60
122	50
113	45
105	40.56
104	40
100	37.8
98.5	36.9
95	35
86	30
77	25
68	20
50	10
41	5
32	0
23	-5
14	-10
+5	-15
-4	-20
-13	-25
-22	-30
-4	-40
-76	-60

1° F. = 5/9 ° C.
 1.8° F. = 1° C.
 3.6° F. = 2° C.
 4.5° F. = 2.5° C.
 5.4° F. = 3° C.

Measuring an Instrument Guidelines

How to Measure Your Instrument

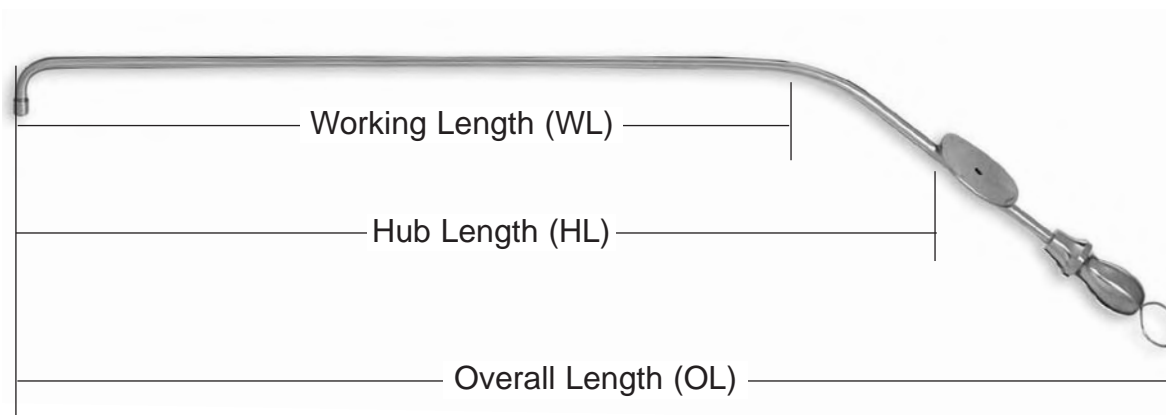
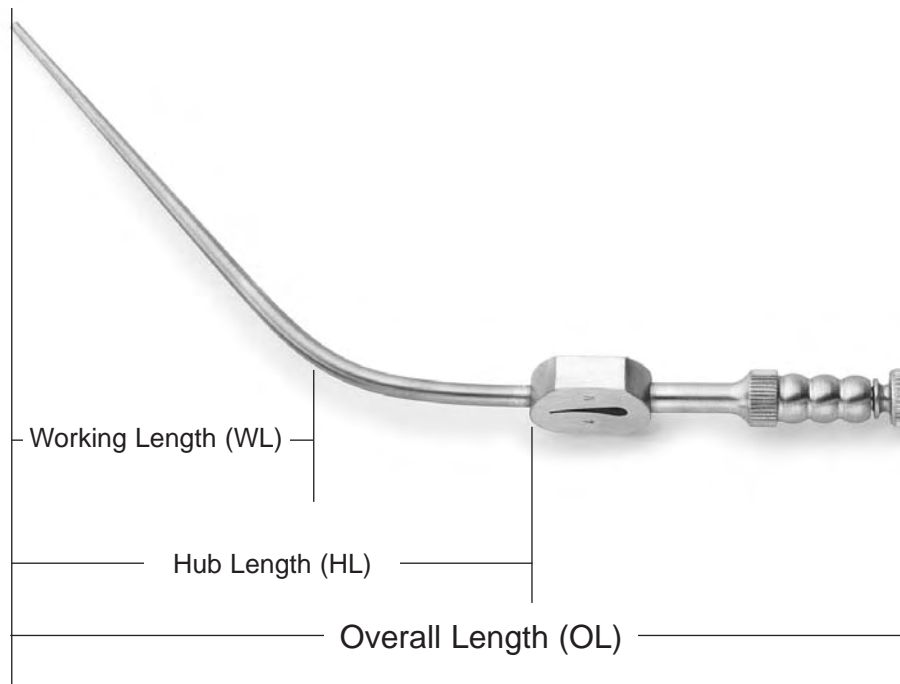
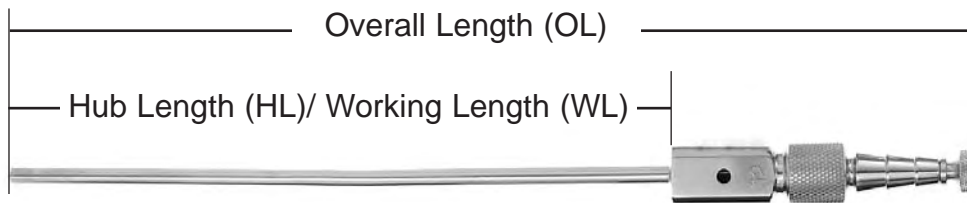

How to Measure Your Instrument

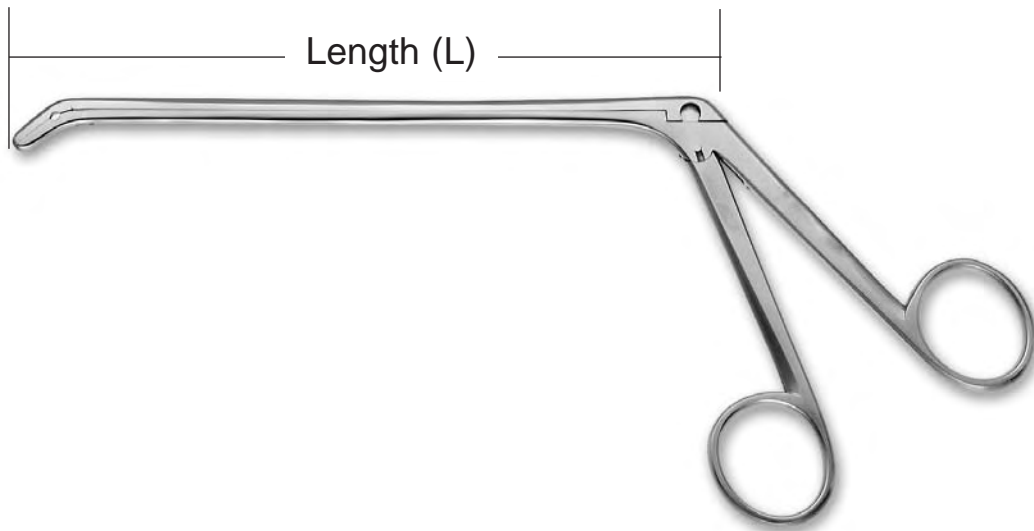
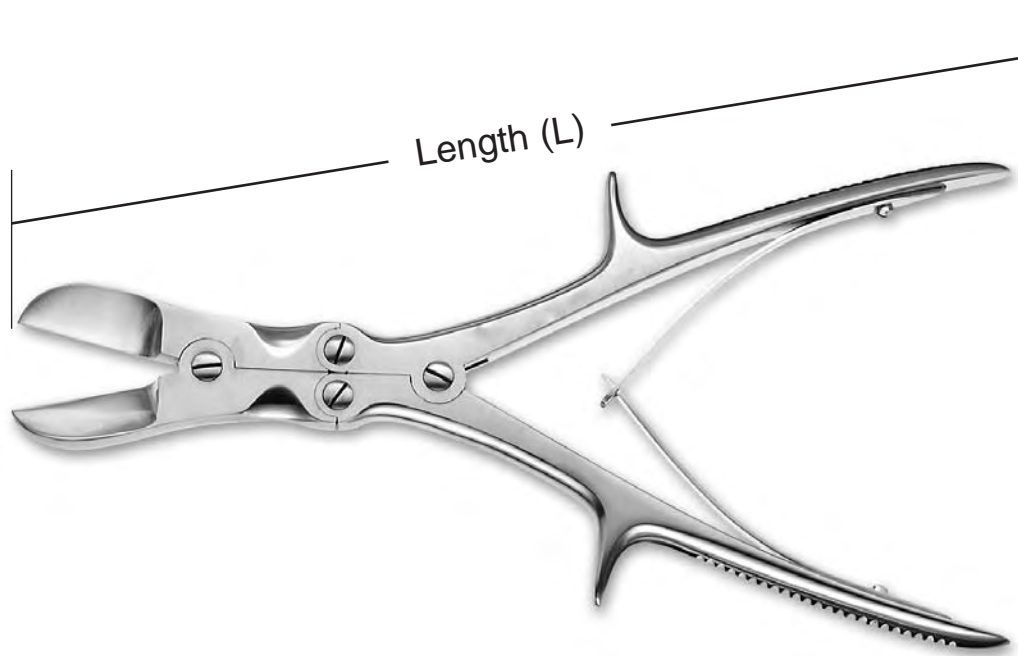

Measuring an Instrument Guidelines

How to Measure Your Instrument

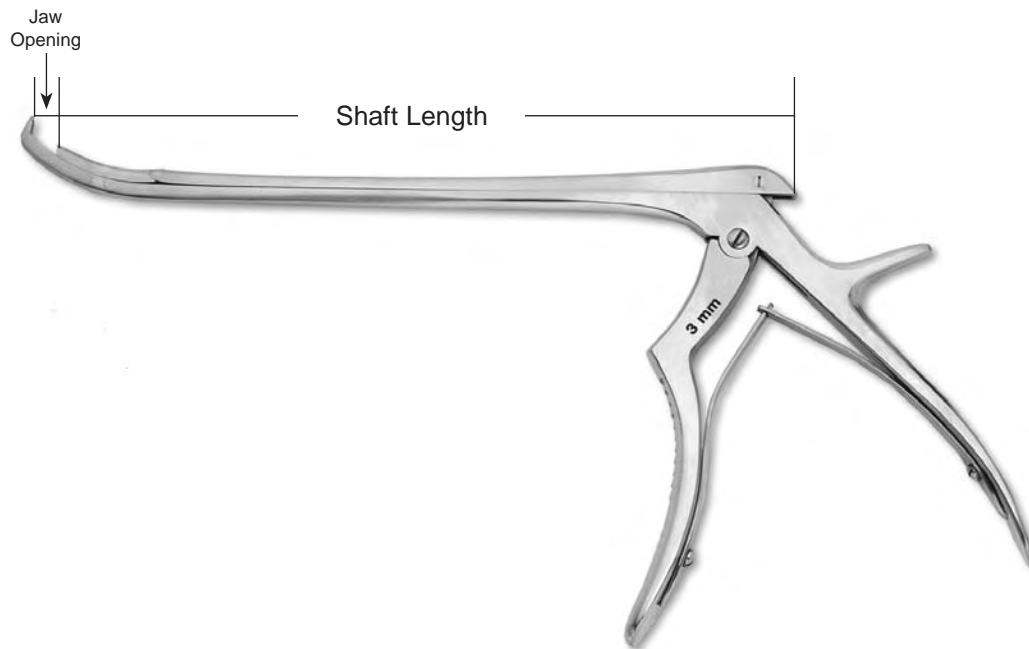
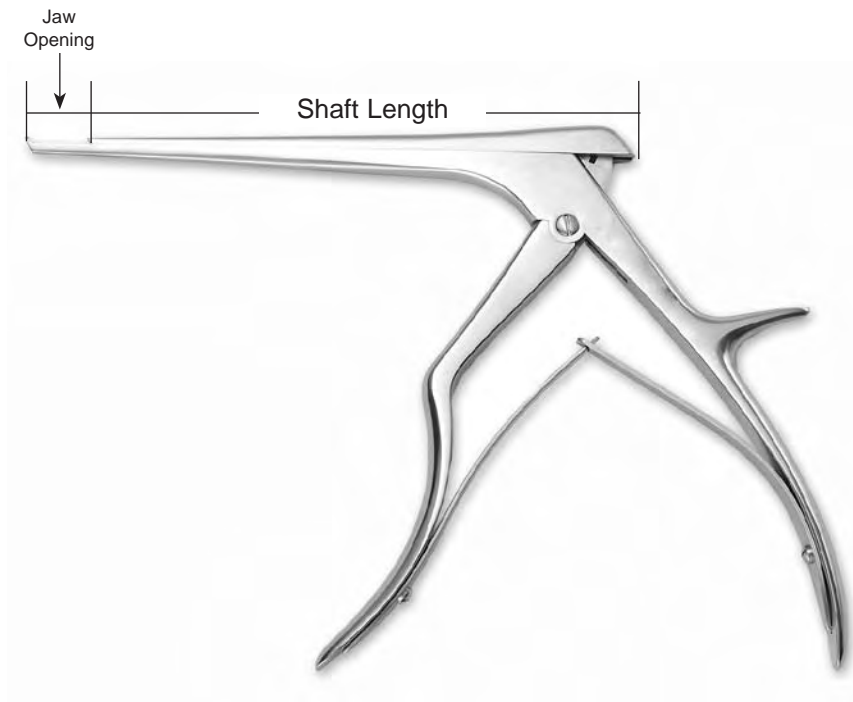



J. Jamner Surgical Instruments, Inc.
9 Skyline Drive
Hawthorne, NY 10532

Distributed by:
Integra NeuroSciences
311 Enterprise Drive
Plainsboro, NJ 08536
Tel: (800) 654 2873
Fax: (609) 275 5363

Caution:

U.S. law restricts these devices to sale by or on the order of a physician.

All text and diagrams contained in this catalog are intended as guidelines and are for illustrative purposes only. No information included in this catalog is intended to replace the Directions for Use packaged with each Integra product. Always refer to the appropriate Directions for Use for complete clinical instructions.

The wave Integra logo and Ruggles are trademarks of Integra LifeSciences Corporation.



Distributed by:
Integra NeuroSciences
 311 Enterprise Drive
 Plainsboro, NJ 08536
www.Integra-LS.com

USA and Canada

800-654-2873
 609-275-0500
 914-592-7114 (Outside USA)
 609-275-5363 (Fax)

England

+44 (0) 1264 345 700
 +44 (0) 1264 332 113 (Fax)

France

+33 (0) 493 95 56 00
 +33 (0) 493 95 56 60 (Fax)

Germany

0800 10 10 755
 06995 775 477 (Fax)