

Gynäkologie
Gynecology
Gynécologie
Ginecología
Ginecologia

Scheiden-Spekula
Vaginal Specula
Spéculum vaginaux
Espéculos vaginales
Specoli vaginali



GRAVE Fig.	mm	Standard	Laser Mod.
1	75x20	70.110.01	
2	95x35	70.110.02	70.114.02
3	115x35	70.110.03	70.114.03



PEDERSON Fig.	mm
70.120.01	1 75x13
70.120.02	2 100x22
70.120.03	3 120x25

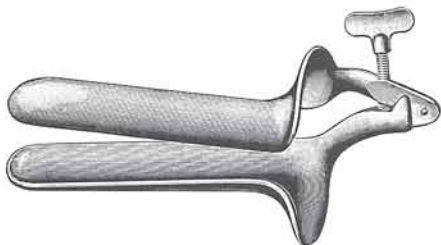

COLLIN Fig.	mm
70.130.01	1 85x30
70.130.02	2 100x35
70.130.03	3 110x40

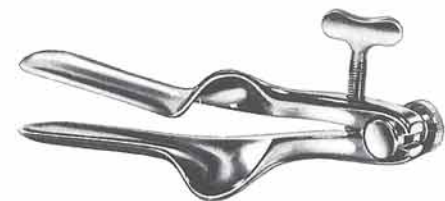

COLLIN
70.131.00
65x20 mm

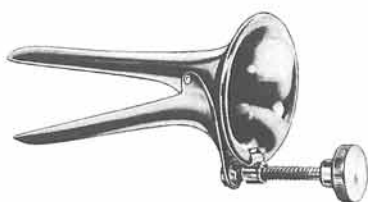

COLLIN
70.132.00
65x10 mm



Seitl. Schraube
Lateral Screw
Vis latérale
Tornillo lateral
Vite laterale

CUSCO Fig.	mm	Standard	Laser Mod.
1	75x32	70.140.01	
2	85x35	70.140.02	70.144.02
3	100x35	70.140.03	70.144.03

Gynäkologie
Gynecology
Gynécologie
Ginecología
Ginecologia



Scheiden-Spekula
Vaginal Specula
Spéculums vaginaux
Espéculos vaginales
Specoli vaginali

CUSCO
70.142.00
75x17 mm

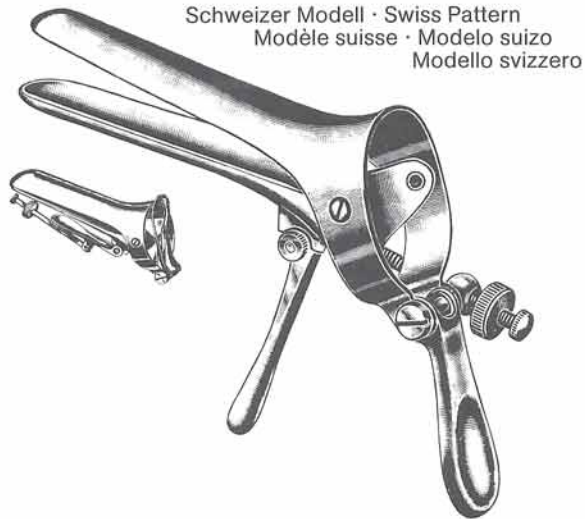

Schweizer Modell · Swiss Pattern
Modèle suisse · Modelo suizo
Modello svizzero

CUSCO	Fig.	mm
70.160.01	1	90x23-25
70.160.02	2	100x25-27
70.160.03	3	110x27-30

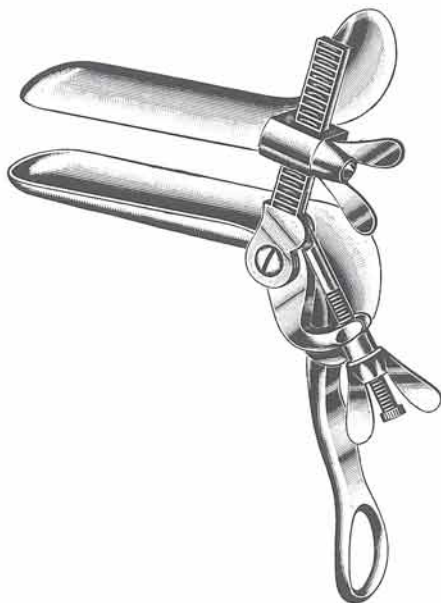

TRELAT	mm
70.180.01	85x33
70.180.02	95x35
70.180.03	115x43

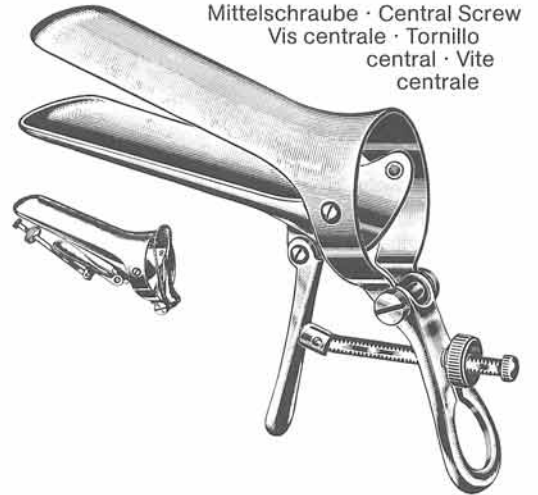

Mittelschraube · Central Screw
Vis centrale · Tornillo
central · Vite
centrale

CUSCO	Fig.	mm
70.150.01	1	75x32
70.150.02	2	85x36
70.150.03	3	95x37



SEMM	mm
70.190.01	100x17-20
70.190.02	100x25-30

Gynäkologie
Gynecology
Gynécologie
Ginecología
Ginecologia

Scheiden-Spekula
Vaginal Specula
Spéculums vaginaux
Espéculos vaginales
Specoli vaginali

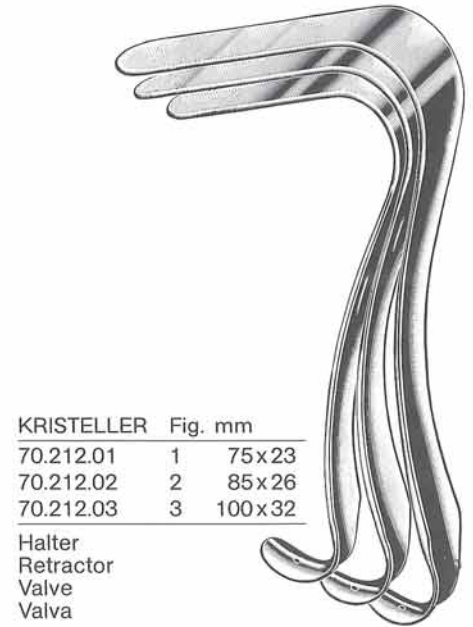
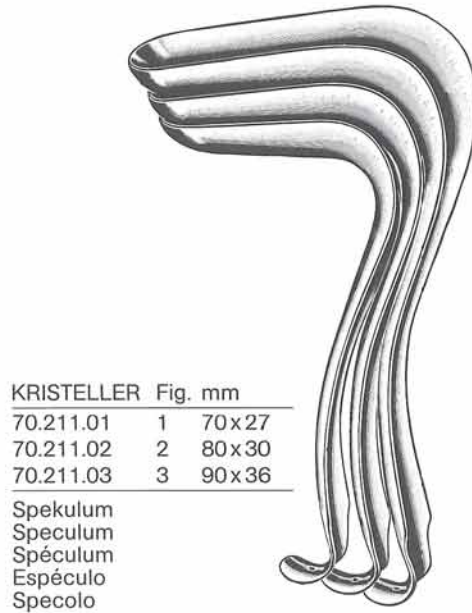
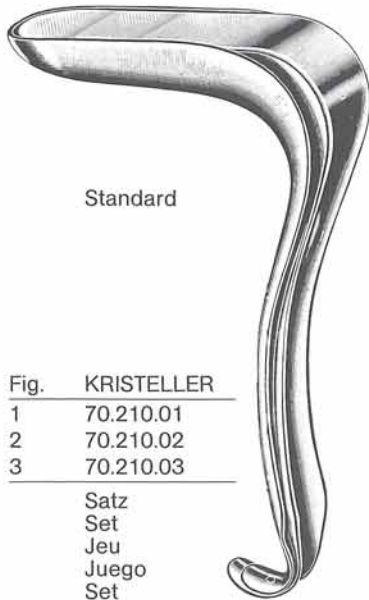

Mit konischen Blättern, für Jungfrauen
With taper blades, for virgins
A valves coniques, pour vierges
Con hojas cónicas, para vírgenes
Con valve coniche, per vergini

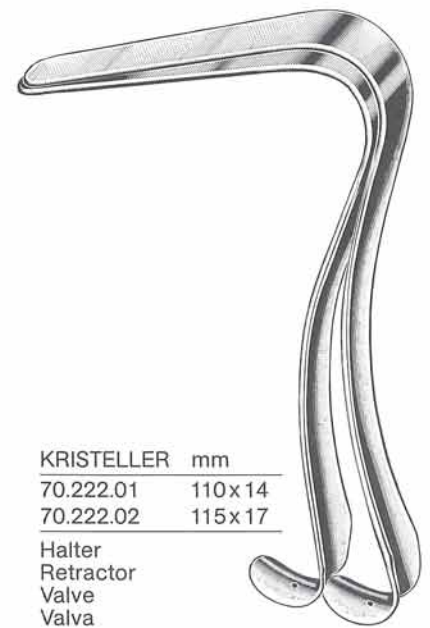
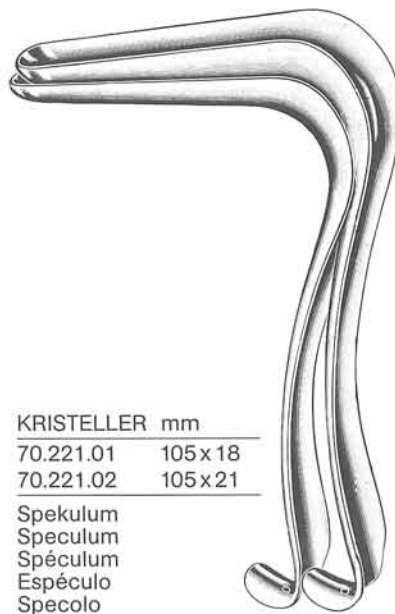
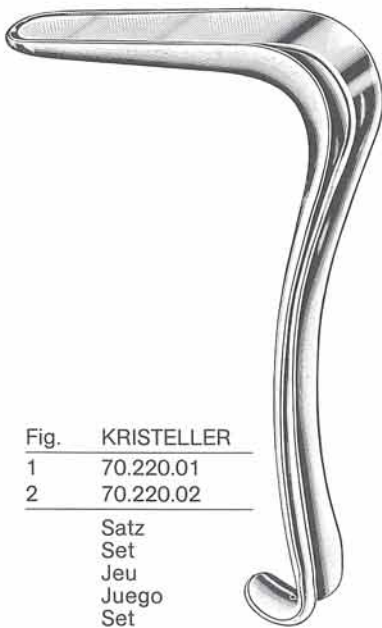



Flache Specula
 Specula Flat Hollow
 Spéculums plats
 Espéculos con huecos planos
 Specoli piatti

Fig.	KRISTELLER
1	70.230.01
2	70.230.02
3	70.230.03
Satz	
Set	
Jeu	
Juego	
Set	

KRISTELLER	Fig.	mm
70.231.01	1	105x26
70.231.02	2	105x28
70.231.03	3	105x33
Spekulum		
Speculum		
Spéculum		
Espéculo		
Specolo		

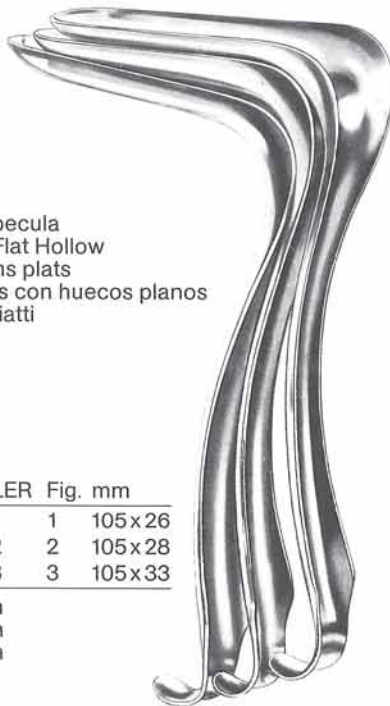

KRISTELLER	Fig.	mm
70.232.01	1	115x22
70.232.02	2	115x24
70.232.03	3	115x29
Halter		
Retractor		
Valve		
Valva		

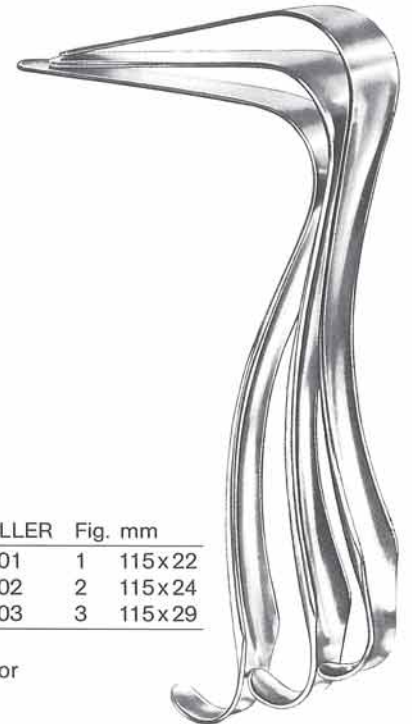

Tiefe Spekula
 Specula Deep Hollow
 Spéculums profonds
 Espéculos con huecos profundos
 Specoli profondi

Fig.	KRISTELLER
1	70.240.01
2	70.240.02
3	70.240.03
Satz	
Set	
Jeu	
Juego	
Set	

KRISTELLER	Fig.	mm
70.241.01	1	110x27
70.241.02	2	110x30
70.241.03	3	110x36
Spekulum		
Speculum		
Spéculum		
Espéculo		
Specolo		

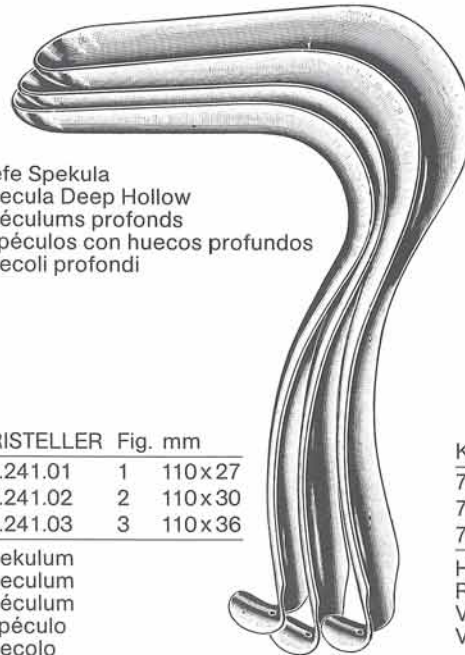

KRISTELLER	Fig.	mm
70.242.01	1	115x23
70.242.02	2	115x26
70.242.03	3	115x32
Halter		
Retractor		
Valve		
Valva		

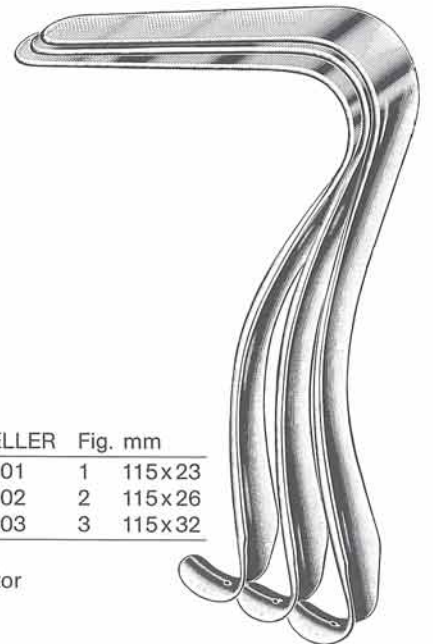

Gynäkologie
Gynecology
Gynécologie
Ginecología
Ginecologia

Scheiden-Spekula
Vaginal Specula
Spéculums vaginaux
Espéculos vaginales
Specoli vaginali



Extra großes Modell
Extra large pattern
Modèle extra grand
Modelo muy grande
Modello molto grande

KRISTELLER
70.250.00
Set

KRISTELLER
70.251.00
135x36 mm

KRISTELLER
70.252.00
140x30 cm

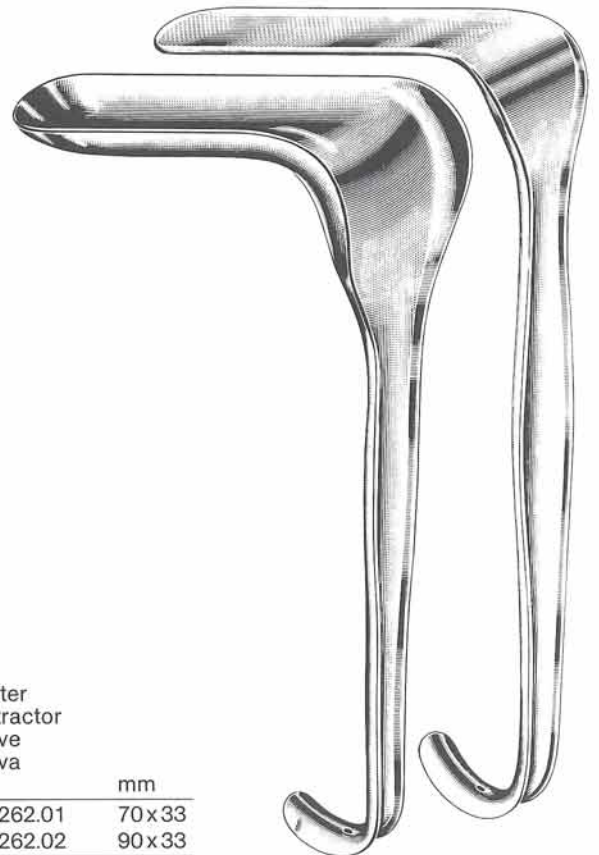

KALLMORGEN
70.260.01-70.262.02

KALLMORGEN	Fig.	Set	Spekulum Speculum Spéculum Espéculo Specolo	mm	Halter Retractor Valve Valva	mm
	1	70.260.01	70.261.01	70x40	70.262.01	70x33
	2	70.260.02	70.261.02	90x40	70.262.02	90x33

Scheiden-Spekula
Vaginal Specula
Spéculum vaginaux
Espéculos vaginales
Specoli vaginali

Gynäkologie
Gynecology
Gynécologie
Ginecología
Ginecologia

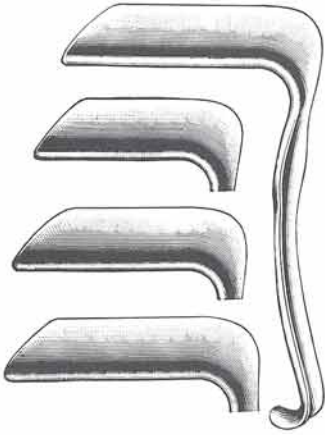

JACKSON	Fig.	mm
70.271.01	1	75x38
70.271.02	2	90x38
70.271.03	3	100x38



Fig. 1 = klein/small/petit
pequeño/piccolo
Fig. 2 = mittel/medium/moyen
mediano/medio
Fig. 3 = groß/large/grand
grande

SIMS	Fig.
70.281.01	1
70.281.02	2
70.281.03	3

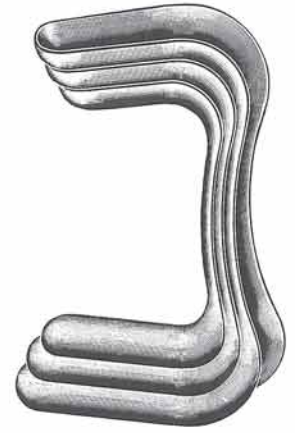

SIMS	Fig.
70.291.01	1
70.291.02	2
70.291.03	3
70.291.00 = Set	



DOYEN	Fig.	mm
70.301.01	1	55x35
70.301.02	2	85x35
70.301.03	3	115x35
70.303.01	1	55x45
70.303.02	2	85x45
70.303.03	3	115x45
70.303.04	4	160x45
70.305.01	1	55x60
70.305.02	2	85x60
70.305.03	3	115x60
70.305.04	4	160x60

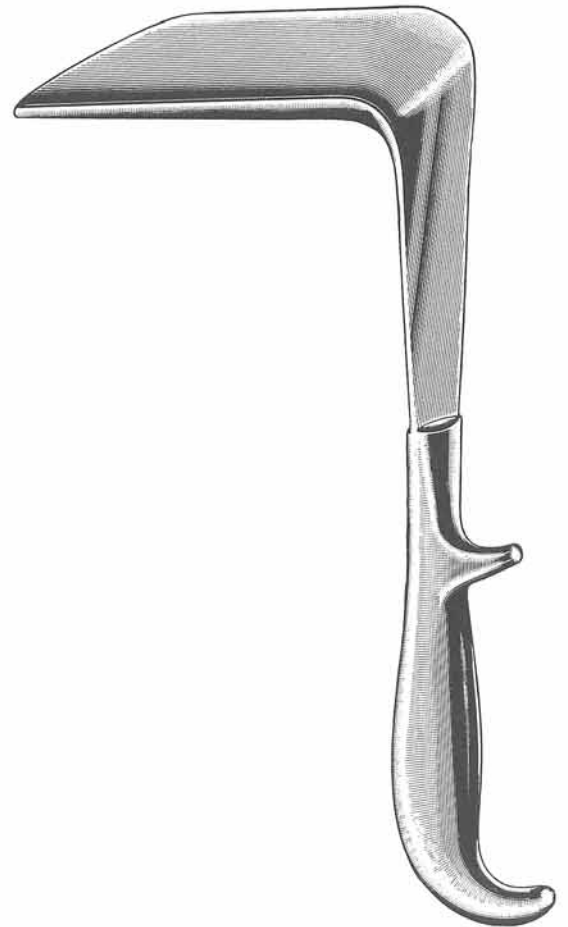

DOYEN
70.301.01-70.305.04

Gynäkologie
 Gynecology
 Gynécologie
 Ginecología
 Ginecologia

Scheiden-Spekula
 Vaginal Specula
 Spéculums vaginaux
 Espéculos vaginales
 Specoli vaginali

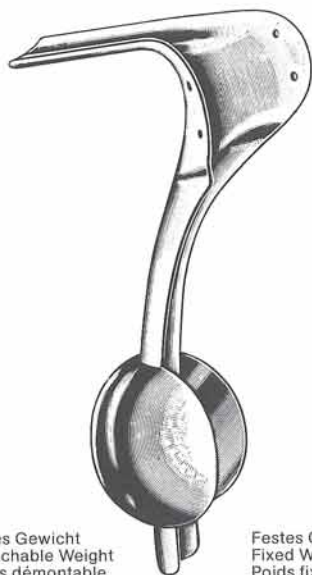

Loses Gewicht
 Detachable Weight
 Poids démontable
 Pesa desmontable
 Peso smontabile

AUVARD

70.307.00

Festes Gewicht
 Fixed Weight
 Poids fixe
 Pesa fija
 Peso fisso

70.309.00



mm	BREISKY
100x20	70.310.20
100x25	70.310.25
100x30	70.310.30
100x35	70.310.35
100x40	70.310.40
130x20	70.313.20
130x25	70.313.25
130x30	70.313.30
130x35	70.313.35
130x40	70.313.40
155x40	70.315.40



mm	LANDAU
100x28	70.319.28
100x38	70.319.38

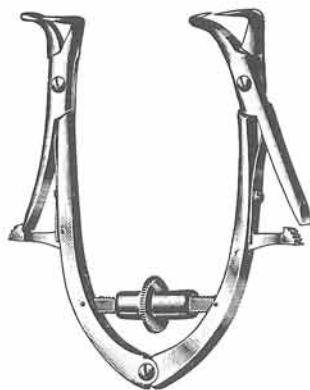

FRIEDMANN
 70.351.10
 10 cm

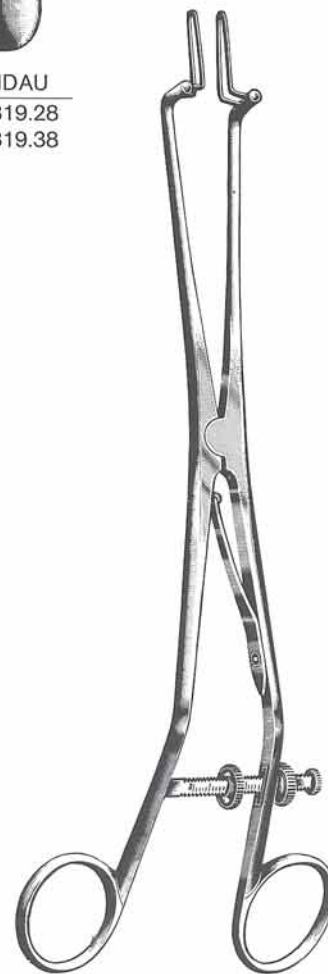

Standard	KOGAN	Laser
70.360.24	24 cm	70.364.24

Uterus-Dilatatoren
 Uterine Dilators
 Dilatateurs utérins
 Dilatadores uterinos
 Dilatatori uterini

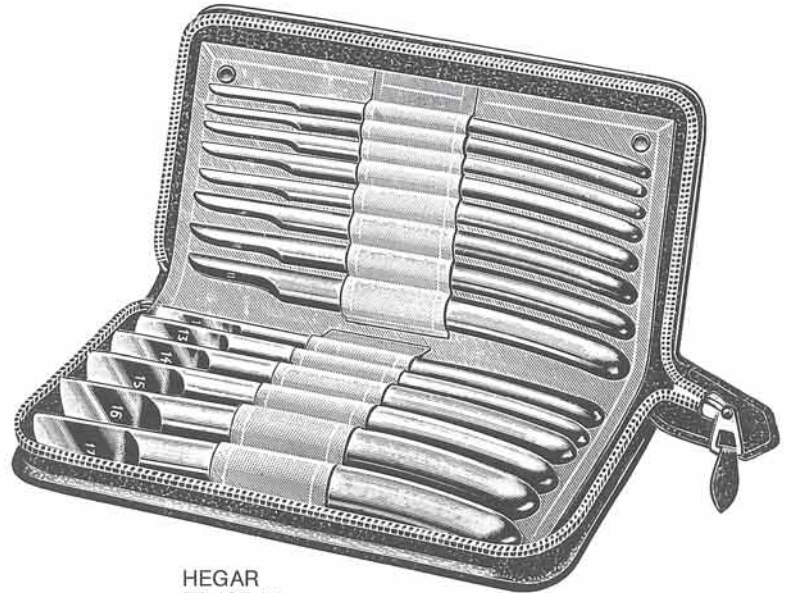

HEGAR
 70.405.14
 4-17 mm
 14 Stück/ea./pces./c./u./pezzi

mm	HEGAR		mm
1	70.410.01	70.415.01	1,5
2	70.410.02	70.415.02	2,5
3	70.410.03	70.415.03	3,5
4	70.410.04	70.415.04	4,5
5	70.410.05	70.415.05	5,5
6	70.410.06	70.415.06	6,5
7	70.410.07	70.415.07	7,5
8	70.410.08	70.415.08	8,5
9	70.410.09	70.415.09	9,5
10	70.410.10	70.415.10	10,5
11	70.410.11	70.415.11	11,5
12	70.410.12	70.415.12	12,5
13	70.410.13	70.415.13	13,5
14	70.410.14	70.415.14	14,5
15	70.410.15	70.415.15	15,5
16	70.410.16	70.415.16	16,5
17	70.410.17		
18	70.410.18		
19	70.410.19		
20	70.410.20		
21	70.410.21		
22	70.410.22		
23	70.410.23		
24	70.410.24		
25	70.410.25		
26	70.410.26		
27	70.410.27		
28	70.410.28		
29	70.410.29		
30	70.410.30		

70.404.14 Satz/Set/Jeu/Juego
 70.410.04-70.410.17 = 14
 70.404.26 Satz/Set/Jeu/Juego
 70.410.01-70.410.26 = 26



mm HEGAR
 4-17 70.406.14 14 Stück/ea./pces./c./u./pezzi
 1-26 70.406.26 26 Stück/ea./pces./c./u./pezzi

Uterus-Dilatatoren
 Uterine Dilators
 Dilatateurs utérins
 Dilatadores uterinos
 Dilatatori uterini

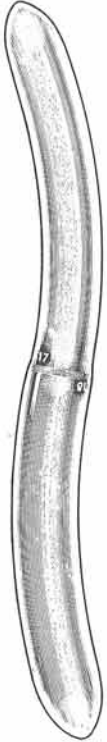

mm	HEGAR	
1/ 2	70.420.01	
3/ 4	70.420.03	
5/ 6	70.420.05	
7/ 8	70.420.07	
9/10	70.420.09	
11/12	70.420.11	
13/14	70.420.13	
15/16	70.420.15	
17/18	70.420.17	
19/20	70.420.19	
21/22	70.420.21	
23/24	70.420.23	
25/26	70.420.25	

70.424.08 Satz/Set/Jeu/Juego
 70.420.03-70.420.17 = 8

70.424.13 Satz/Set/Jeu/Juego
 70.420.01-70.420.25 = 13

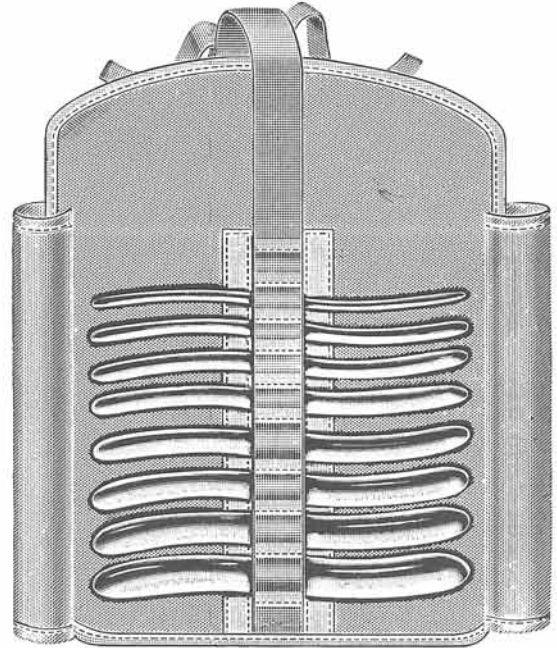

HEGAR
 70.425.08
 3/4-17/18 mm
 8 Stück/ea./pces./c./u./pezzi



mm	HEGAR	
3/4-17/18	70.426.08	8 Stück/ea./pces./c./u./pezzi
1/2-25/26	70.426.13	13 Stück/ea./pces./c./u./pezzi

Uterus-Dilatatoren
 Uterine Dilators
 Dilatateurs utérins
 Diladores uterinos
 Dilatori uterini

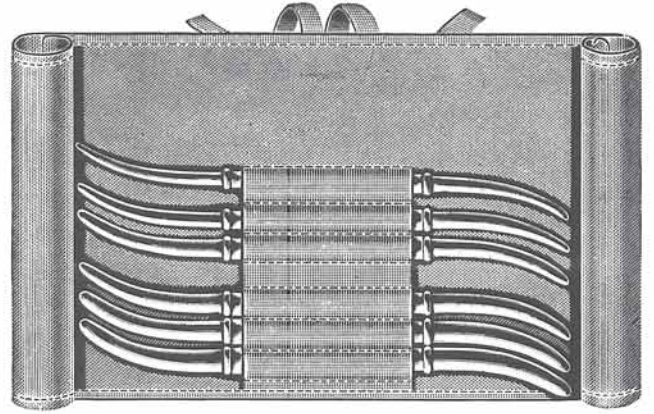
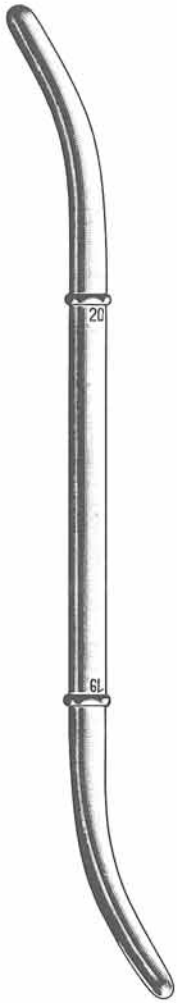

HANK
 70.436.08
 Set/6

mm	HANK	Fig. U.S.
4,5/ 5	70.430.10	9/10
5,5/ 6	70.430.12	11/12
6,5/ 7	70.430.14	13/14
7,5/ 8	70.430.16	15/16
8,5/ 9	70.430.18	17/18
9,5/10	70.430.20	19/20
70.435.06		
Set/6		

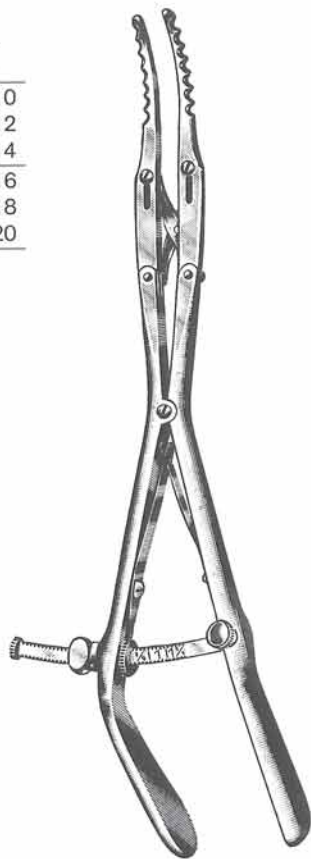

GOODELL
 70.441.34
 34 cm

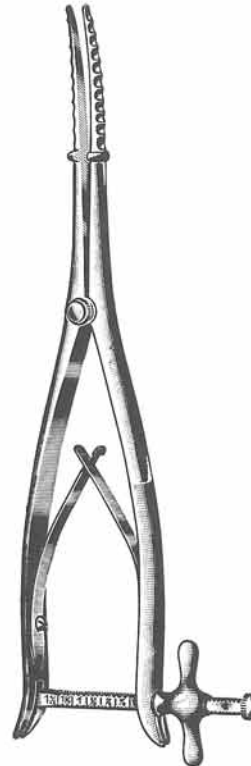

WYLIE
 70.443.29
 29 cm

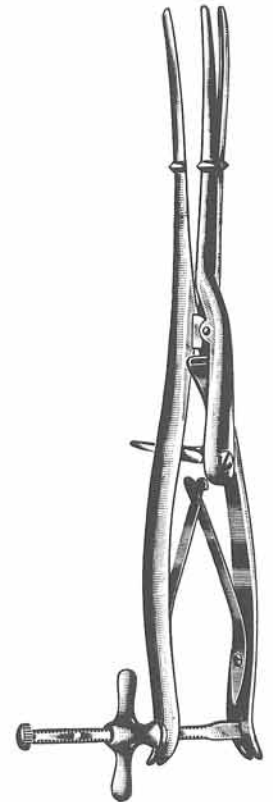

SIMS
 70.445.29
 29 cm

Gynäkologie
Gynecology
Gynécologie
Ginecología
Ginecologia

Hakenzangen
Tenaculum Forceps
Pinces pour abaissement du col de l'utéro
Pinzas para coger el cuello del útero
Pinze per abbassare il collo dell'utero



SCHROEDER
70.502.25
25 cm

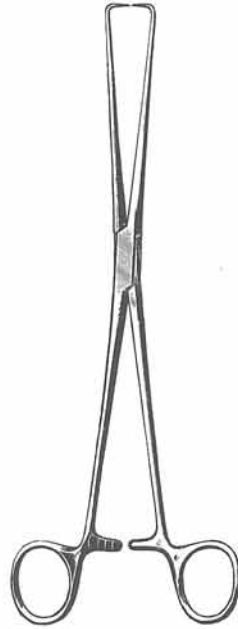

BRAUN
70.504.25
25 cm



SKENE
70.505.24
24 cm



DUPLAY
70.507.28
28 cm

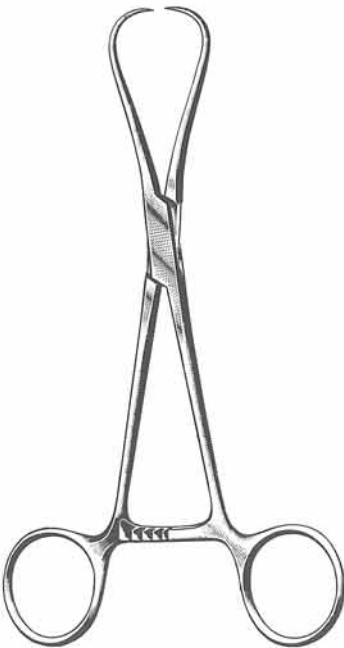

STAUDE-MOORE
70.508.17
17 cm

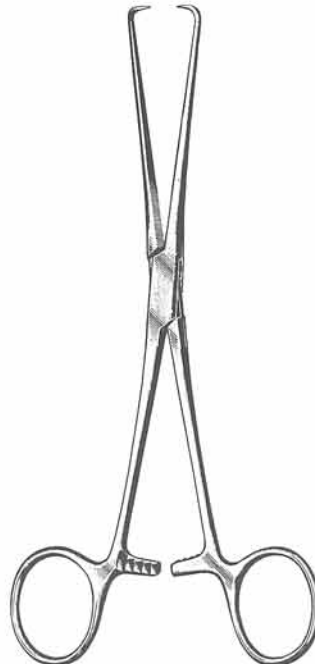

BARRETT
70.510.18
18 cm

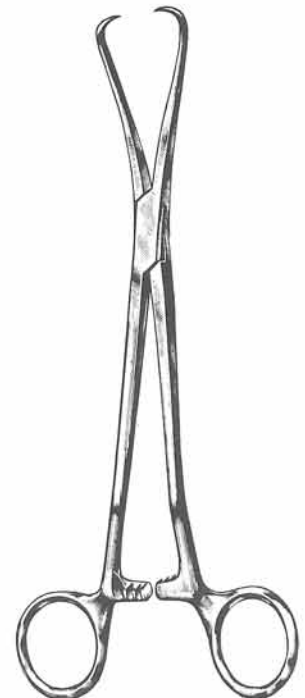

JARCHO
70.512.20
20 cm

Hakenzangen
 Vulsellum Forceps
 Pincès pour abaissement du col de l'utérus
 Pinzas para coger el cuello del útero
 Pinze per abbassare il collo dell'utero

Gynäkologie
 Gynecology
 Gynécologie
 Ginecología
 Ginecologia

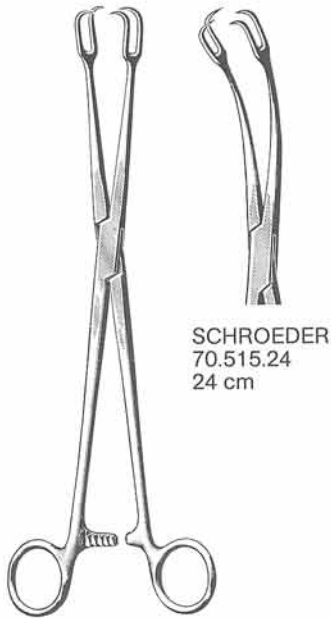

SCHROEDER
 70.515.24
 24 cm

SCHROEDER
 70.514.24
 24 cm

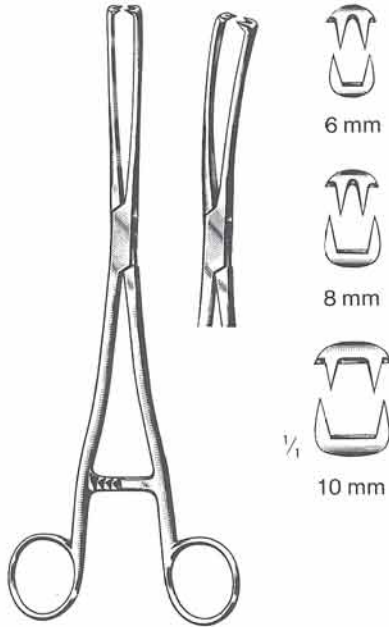

MUSEUX		
70.524.06	6 mm	70.525.06
70.524.08	8 mm	70.525.08
70.524.10	10 mm	70.525.10
24 cm		

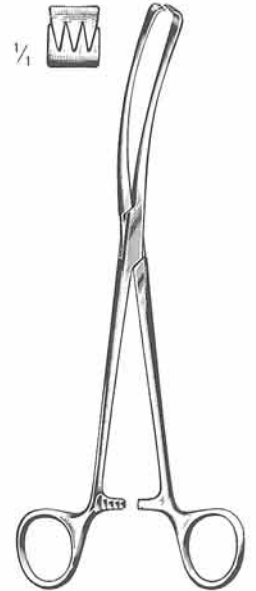

TEALE
 70.531.23
 23 cm

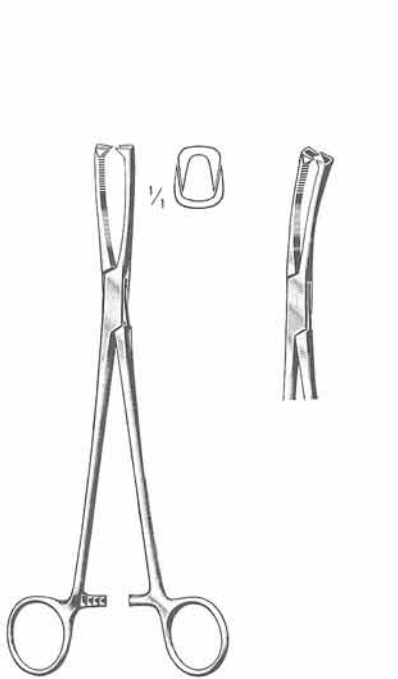

JACOBS
 70.532.21 21 cm 70.533.21

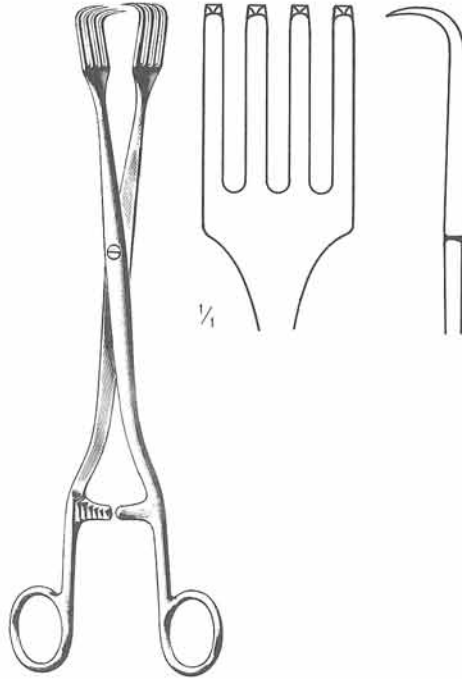

PRATT
 70.536.28
 28 cm



IOWA
 70.539.26
 26 cm

Gynäkologie
 Gynecology
 Gynécologie
 Ginecología
 Ginecologia

Uterus-Polypenzangen
 Uterine Polypus Forceps
 Pincès à polypes utérins
 Pinzas para pólipos uterinos
 Pinze per polipi uterini

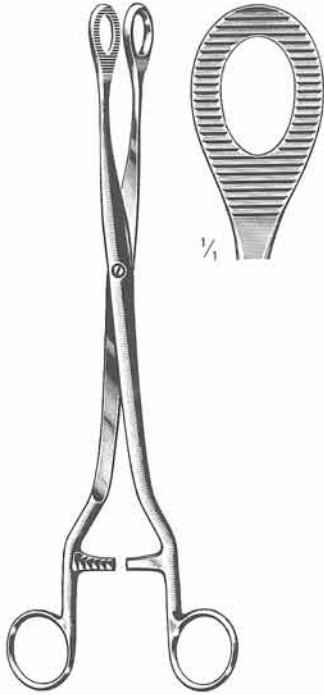

NOTO
 70.540.27
 27 cm



DOYEN
 70.542.20
 20 cm

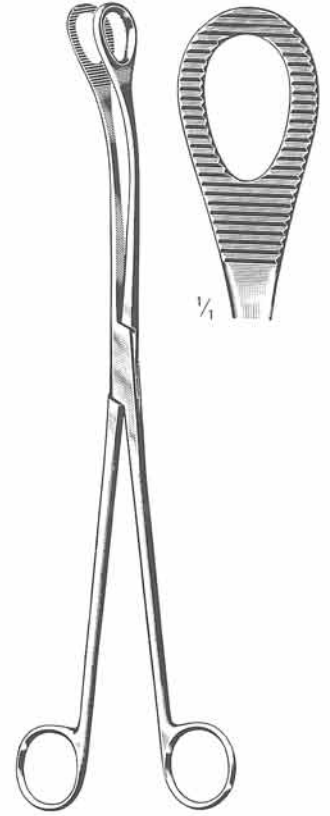

KELLY
 70.543.32
 32 cm

Uterus-Faßzangen
 Uterine Elevating Forceps
 Pincès hystérolabes
 Pinzas para el útero
 Pinze per afferrare l'utero



DARTIGUES
 70.545.27
 27 cm



SOMER
 70.547.23
 23 cm

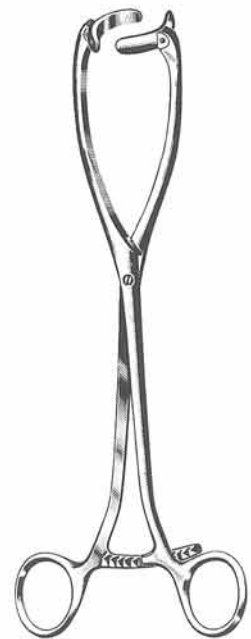

COLLIN
 70.549.25
 25 cm



Amniotom
 Amniotome
 Amniotome
 Amniótomo
 Amniotomo

BEACHAM
 70.559.26
 26 cm



Uterus-Depressoren
 Uterine Depressors
 Dépresseurs utérins
 Depresores uterinos
 Depressori uterini

BRAUN
 70.565.28
 28 cm

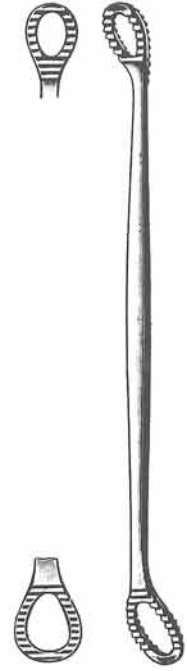

SIMS
 70.567.26
 26 cm



Uterus-Sonden
 Uterine Sounds
 Hystéromètres
 Histerómetros
 Isterometri

starr
 rigid
 rigide
 rigida
 rigida

70.580.32

SIMS

32 cm

biegsam
 malleable
 malléable
 malleable
 malleabile

70.581.32



starr
 rigid
 rigide
 rigida
 rigida

70.582.32

MARTIN

32 cm

biegsam
 malleable
 malléable
 malleable
 malleabile

70.583.32



COLLIN
 70.584.28
 28 cm

Gynäkologie
 Gynecology
 Gynécologie
 Ginecología
 Ginecologia

Uterus-Biopsie-Saugküretten
 Uterine Biopsy Aspirating Curettes
 Curettes aspirantes à biopsie de l'utérus
 Curetas aspiradoras p. la biopsia uterina
 Curette di aspirazione per biopsia



RANDALL
 70.590.04
 24 cm/4 mm



mm	NOVAK
1	70.592.01
2	70.592.02
3	70.592.03
4	70.592.04



KEVORKIAN		
70.594.12	1,2 mm	
70.594.40	4,0 mm	70.596.40
	30 cm	

mit Korb
 with basket
 avec grille
 con cesto
 con cestino

Probeexcisionszangen
 Biopsy Specimen Forceps
 Pincés emporte-pièce pour le col de l'utérus
 Pinzas sacabocado para el cuello del útero
 Pinze taglianti per biopsia

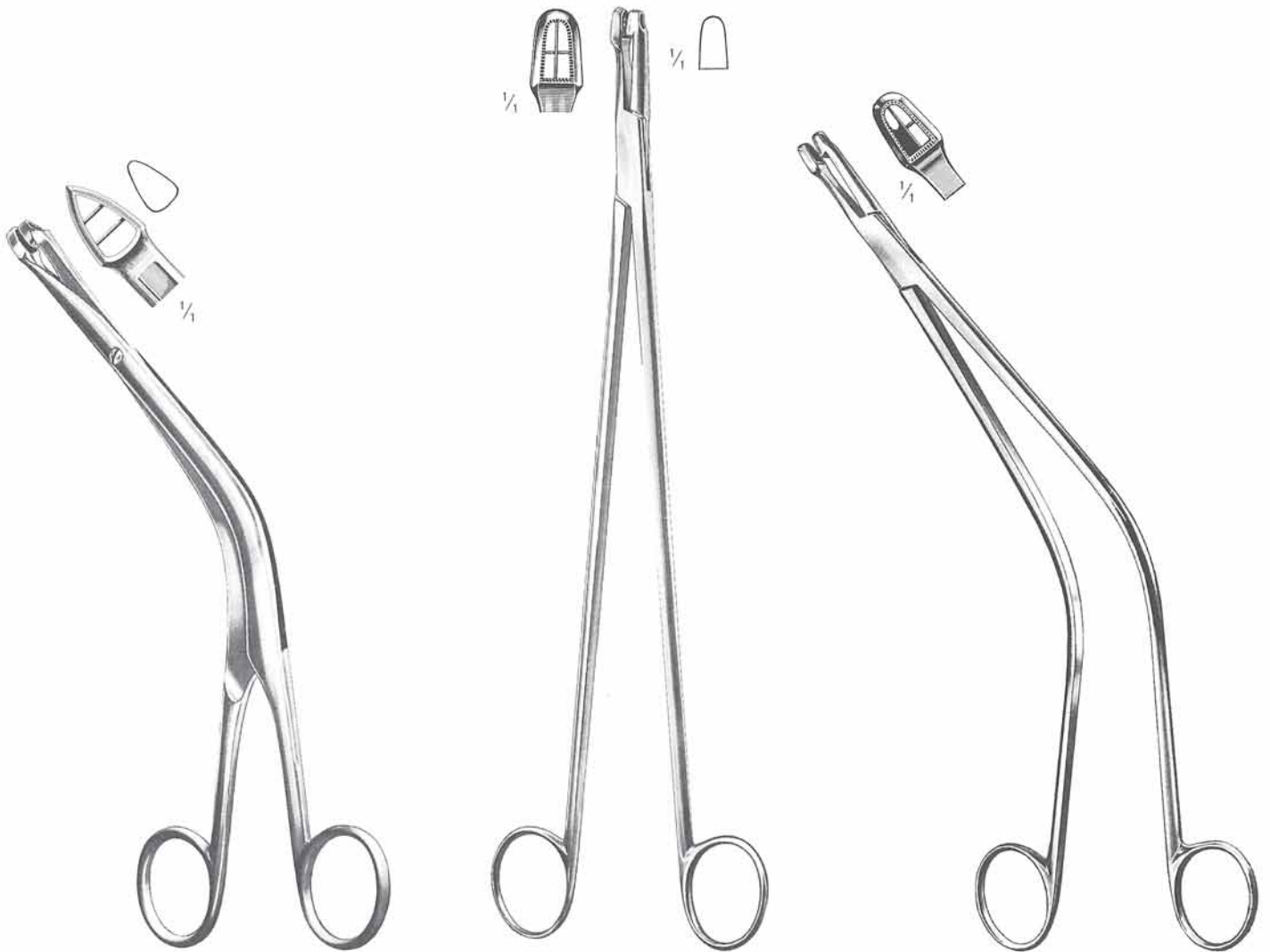

FAURE
 70.601.21
 21 cm

cm	SCHUBERT
21	70.604.21
28	70.604.28

SCHUBERT
 70.605.26
 26 cm

Gynäkologie
 Gynecology
 Gynécologie
 Ginecología
 Ginecologia

Biopsiezangen
 Biopsy Specimen Forceps
 Pincas à biopsie
 Pinzas sacabocado p. biopsia
 Pinze per biopsia

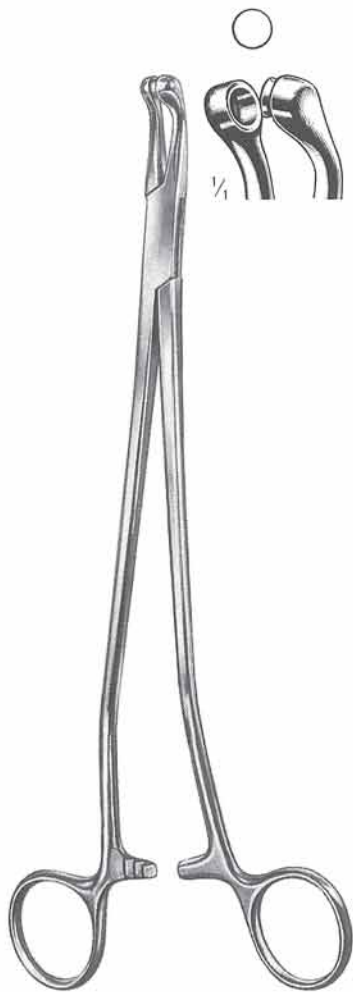

THOMS-GAYLOR
 70.606.24
 24 cm

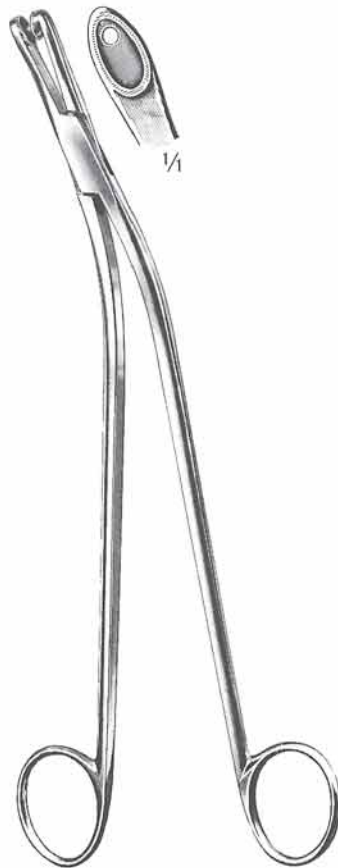

GELLHORN
 70.609.23
 23 cm

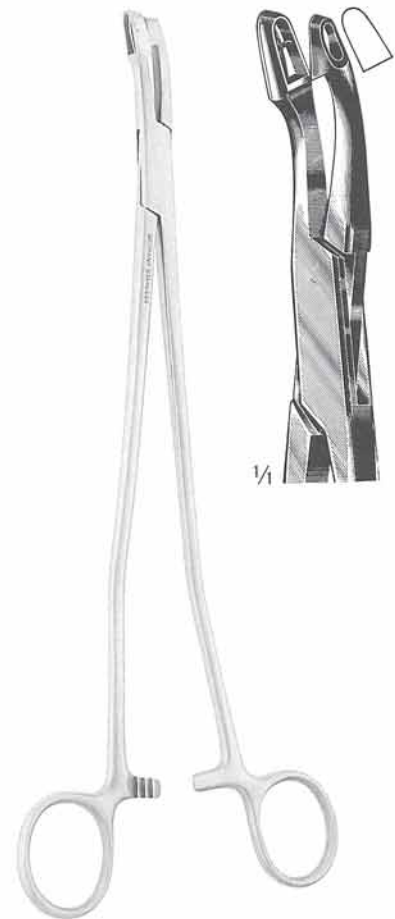

van DOREN
 70.611.25
 25 cm

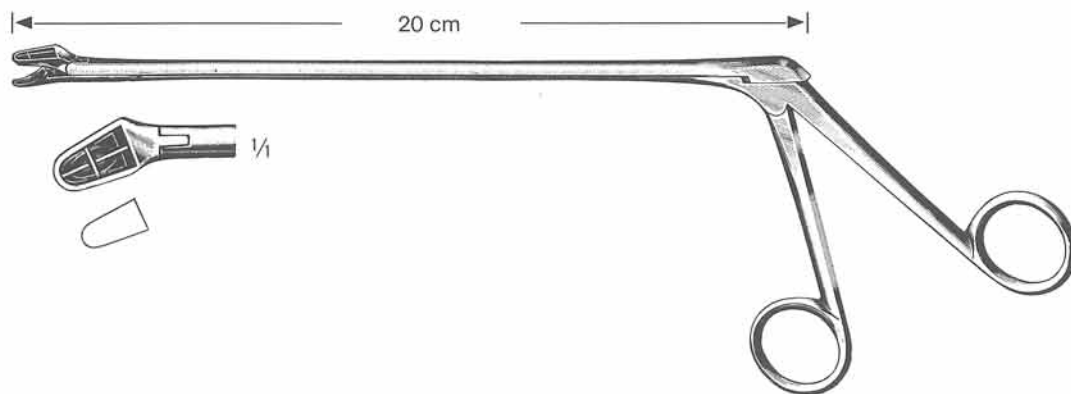

ALEXANDER
 70.613.28
 28 cm

Biopsiezangen
 Biopsy Specimen Forceps
 Pinces à biopsie
 Pinzas sacabocado p. biopsia
 Pinze per biopsia

70.615.01

70.615.02

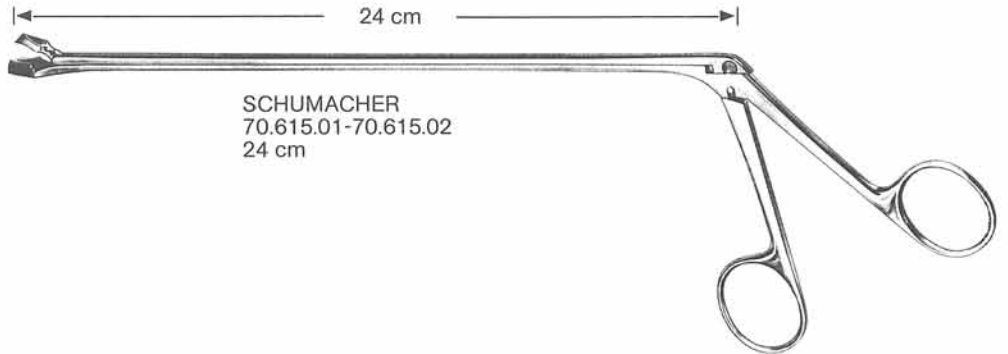

SCHUMACHER
 70.615.01-70.615.02
 24 cm



3x9,7 mm

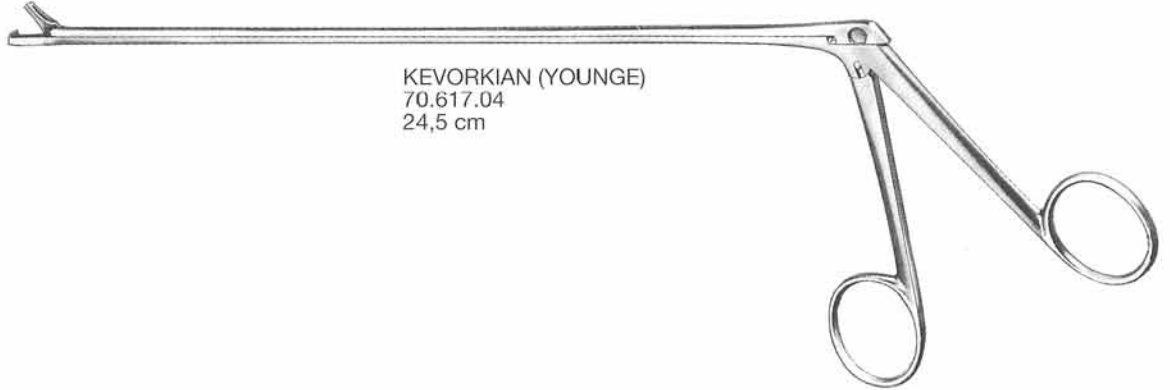

KEVORKIAN (YOUNGE)
 70.617.04
 24,5 cm



4x8 mm

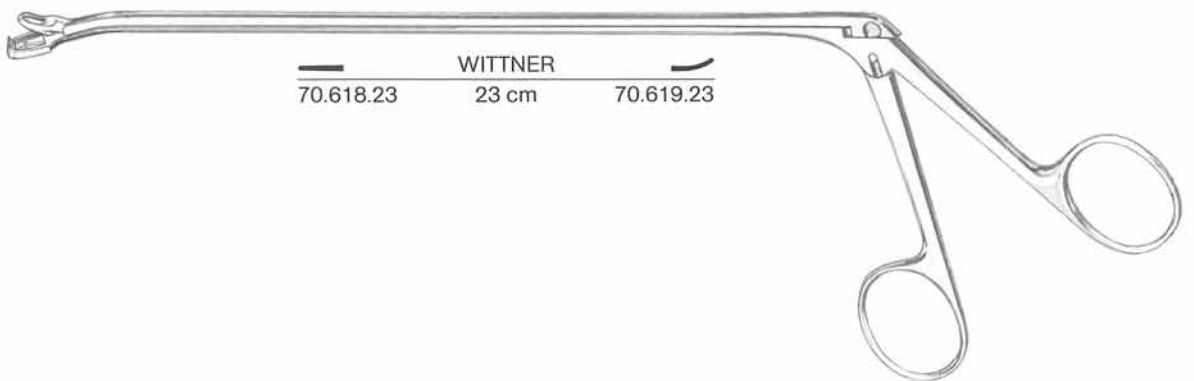

WITTNER
 70.618.23 23 cm 70.619.23



3x7 mm

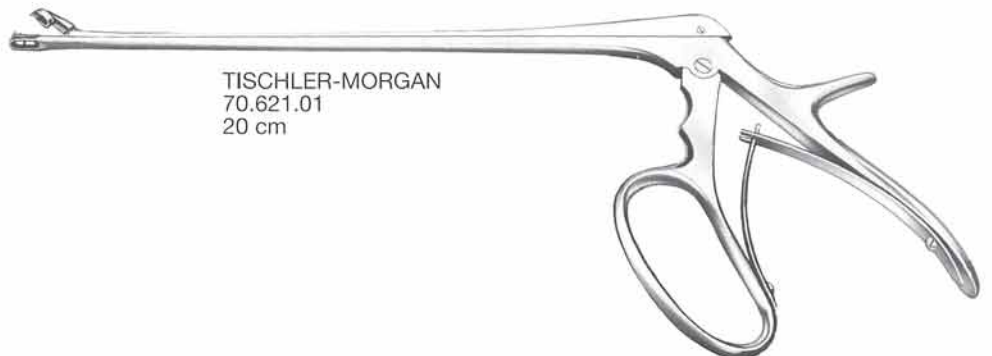

TISCHLER-MORGAN
 70.621.01
 20 cm

Gynäkologie
Gynecolgy
Gynécologie
Ginecología
Ginecologia

Biopsiezangen
Biopsy Specimen Forceps
Pincès à biopsie
Pinzas sacabocado p. biopsia
Pinze per biopsia



oval
7 x 5 mm

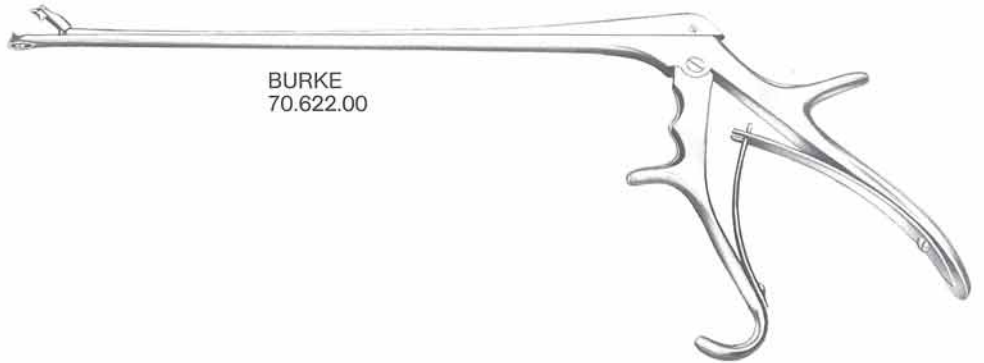

BURKE
70.622.00



Fig. 1

- TISCHLER-Morgan



Fig. 3

oval ● 3,7 x 5 mm

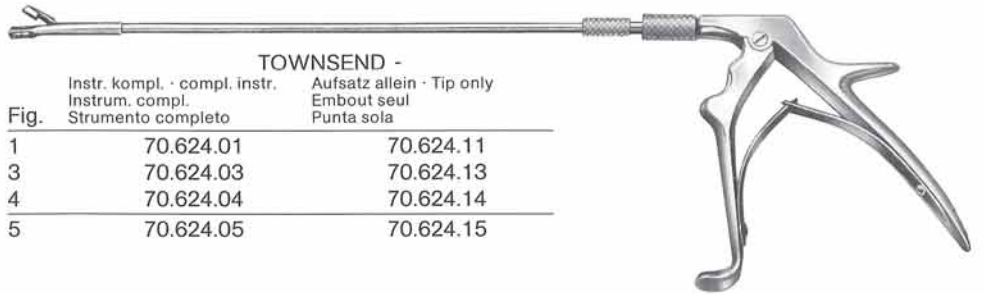

TOWNSEND -

Fig.	Instr. kompl. · compl. instr. Instrum. compl. Strumento completo	Aufsatz allein · Tip only Embout seul Punta sola
1	70.624.01	70.624.11
3	70.624.03	70.624.13
4	70.624.04	70.624.14
5	70.624.05	70.624.15



Fig. 5

mini

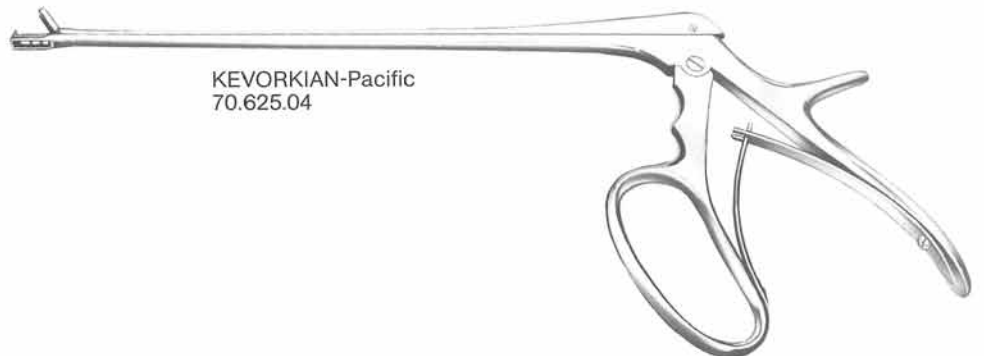

Fig. 4

- KEVORKIAN



■ 3 x 8 mm



KEVORKIAN-Pacific
70.625.04

Biopsiezangen
Biopsy Specimen Forceps
Pinces à biopsie
Pinzas sacabocado p. biopsia
Pinze per biopsia



2,3x4,2 mm



TOWNSEND-Mini (BABY TISCHLER)
70.626.00



3x9,5 mm

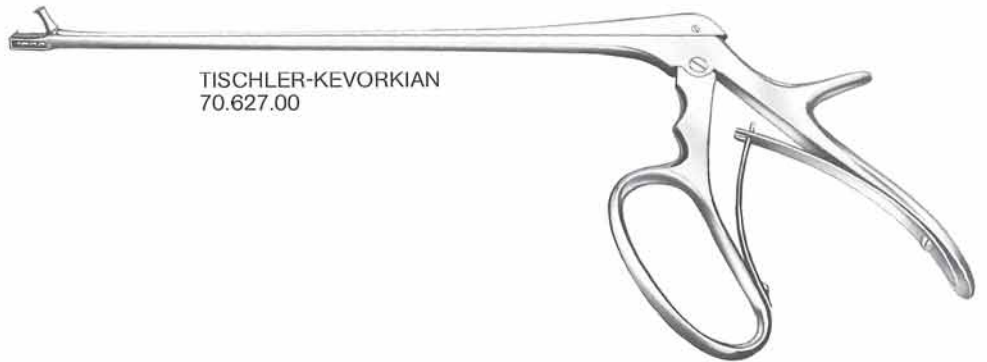

TISCHLER-KEVORKIAN
70.627.00



4x6,5 mm

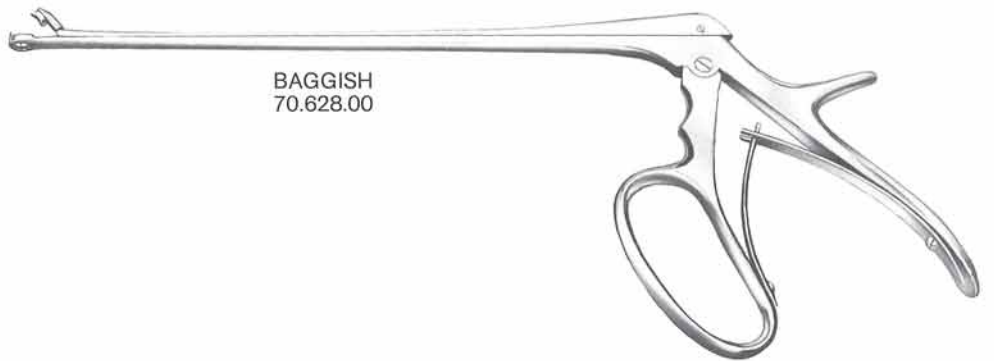

BAGGISH
70.628.00



4,5x8 mm

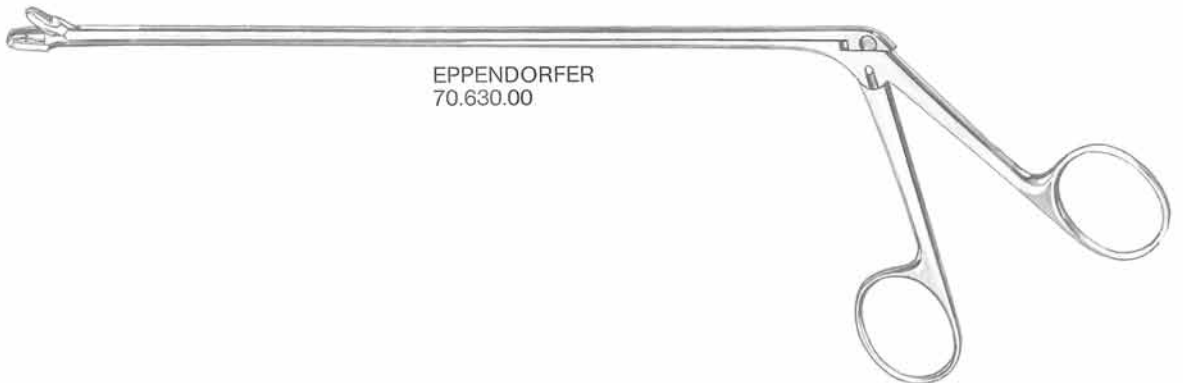

EPPENDORFER
70.630.00

Gynäkologie
Gynecology
Gynécologie
Ginecología
Ginecologia

Biopsiezangen
Biopsy Specimen Forceps
Pincès à biopsie
Pinzas sacabocado p. biopsia
Pinze per biopsia

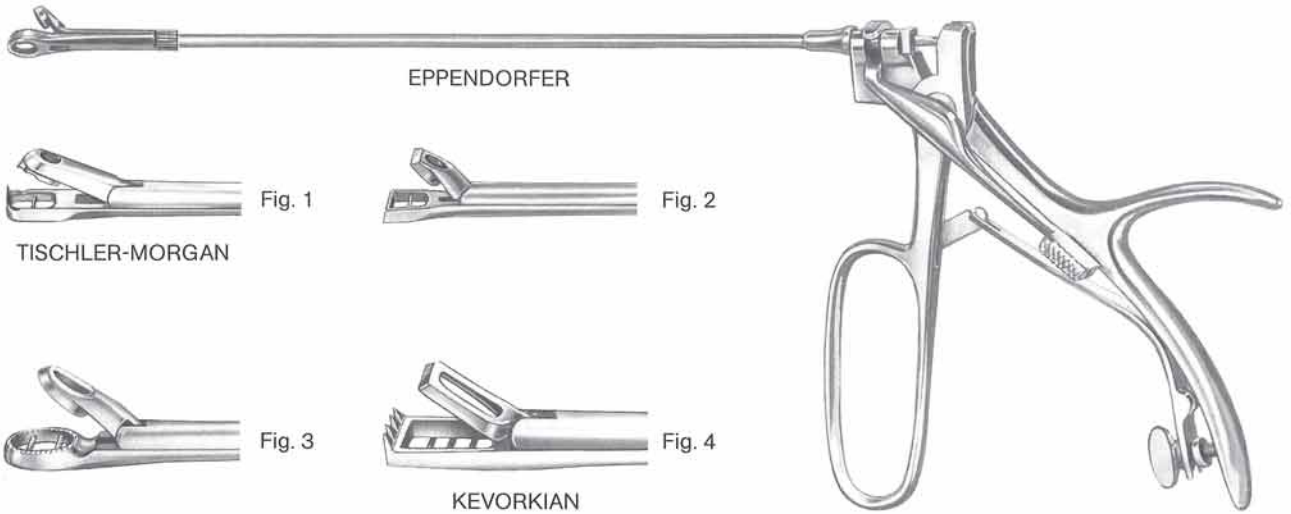

Fig.	Instr. kompl. · compl instr. Instrum. compl. Strumento completo	Aufsatz allein · Tip only Embout seul Punta sola
1	70.632.01	70.632.11
2	70.632.02	70.632.12
3	70.632.03	70.632.13
4	70.632.04	70.632.14

Myom-Heber
Myoma Screw
Tracteur pour fibromes
Tirabuzón para fibromas
Tiramiomi



DOYEN
70.641.17
17 cm

Myommesser
Myoma Knife
Bistouri à fibromes
Bisturi para fibromas
Busturi per fibromi

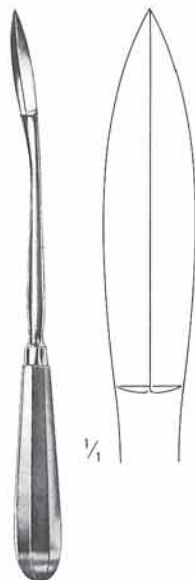

SEGOND
70.643.27
27 cm

Fistelhaken
Fistula Hooks
Crochets à fistules
Ganchos para fistulas
Uncini per fistole

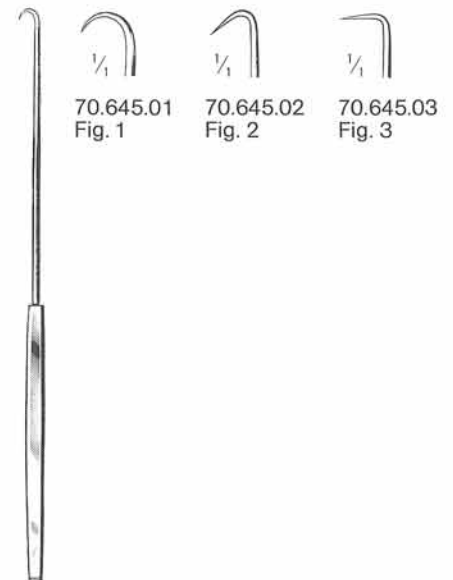

EMMET
70.645.01-70.645.03
22 cm

Gynäkologie
Gynecology
Gynécologie
Ginecología
Ginecologia

Salpingograph
Salpingograph
Salpingographe
Salpingógrafo
Salpingografo

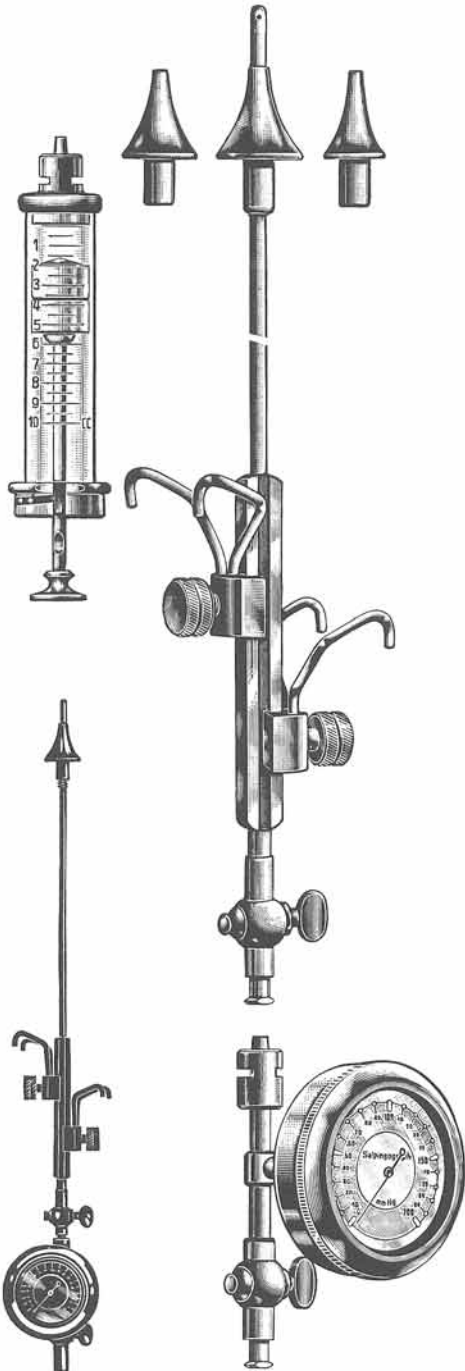

SCHULTZE
70.650.00
compl.

scharf
sharp
tranchant
cortante
tagliente



Uteruslöffel, -kürette
Uterine Curettes
Curettes utérines
Curetas uterinas
Curette uterine

1



2



3



4



5



6

scharf/stumpf
sharp/blunt
tranchant/mousse
cortante/roma
tagliente/smussa



BLAKE
70.704.27
27 cm

Fig.	SIMON
1	70.702.01
2	70.702.02
3	70.702.03
4	70.702.04
5	70.702.05
6	70.702.06

25 cm

Gynäkologie
 Gynecology
 Gynécologie
 Ginecología
 Ginecologia

Uterus-Küretten
 Uterine Curettes
 Curettes utérines
 Curetas uterinas
 Curette uterine

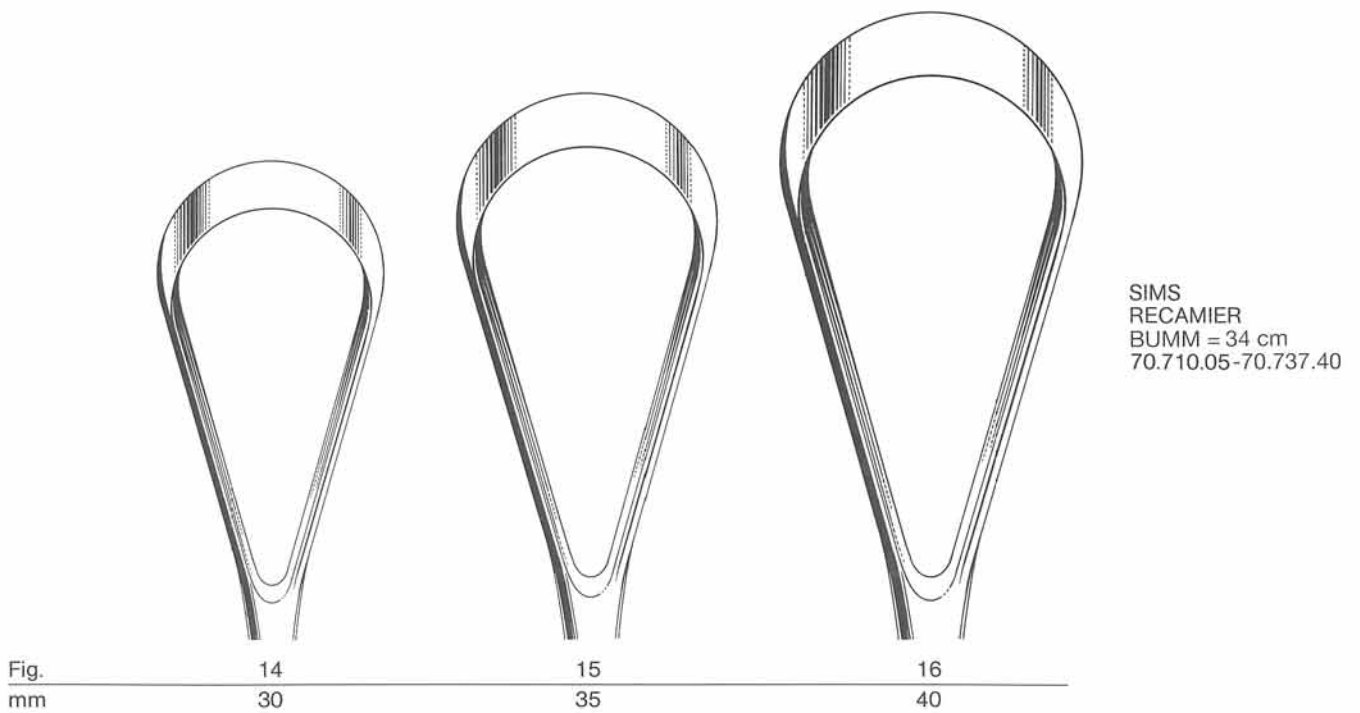
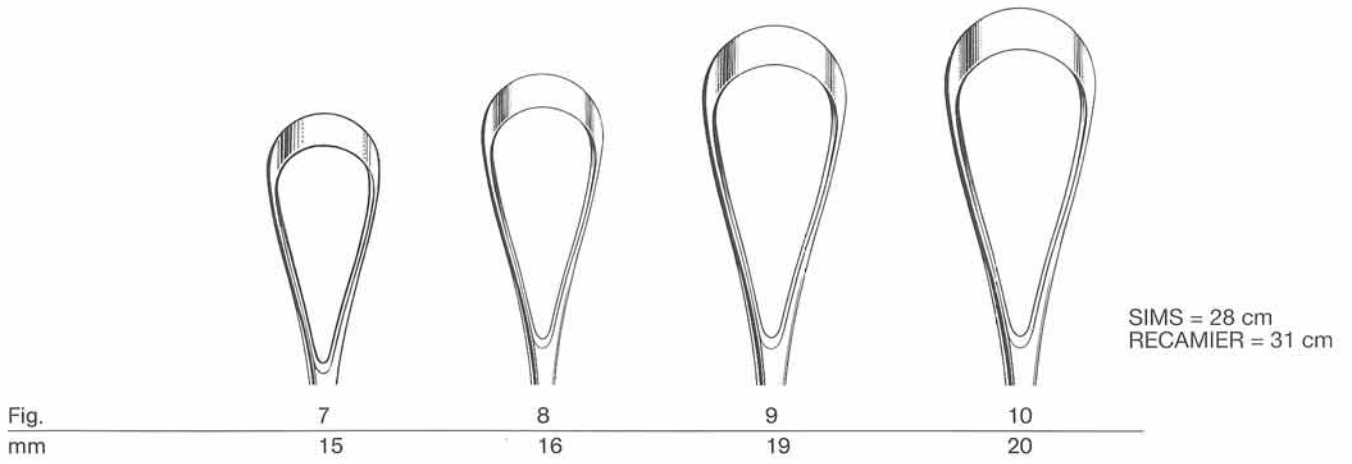
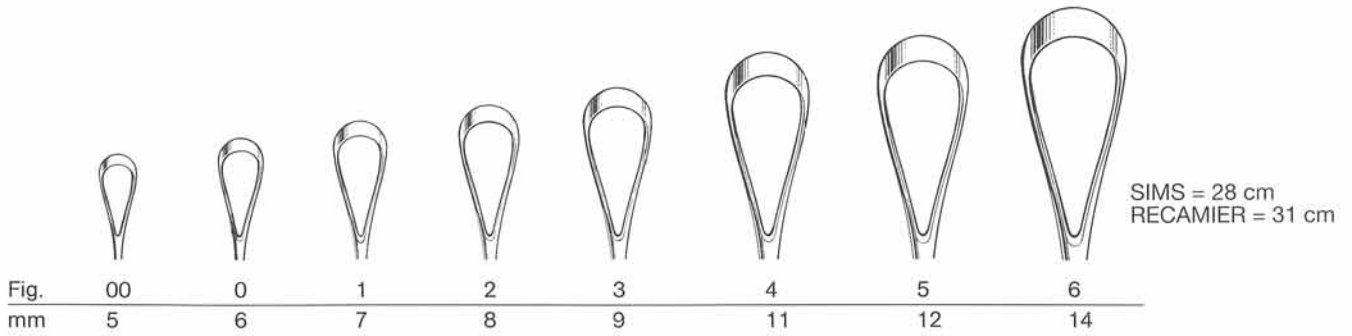

Uterus-Küretten
Uterine Curettes
Curettes utérines
Curetas uterinas
Curette uterine



SIMS
70.710.05-70.717.14
28 cm



RECAMIER
70.720.07-70.727.20
31 cm



BUMM
70.730.30-70.737.40
34 cm

Ausführung	scharf	stumpf
Features	sharp	blunt
Exécution	tranch.	mousse
Ejecución	cort.	roma
Esecuzione	tagl.	smussa
fest./rig.	A	B
flex./fless.	C	D

Fig.	A	B	C	D	A	B	C	D	A	B	C	D
00	70.710.05	70.712.05	70.715.05	70.717.05								
0	70.710.06	70.712.06	70.715.06	70.717.06								
1	70.710.07	70.712.07	70.715.07	70.717.07	70.720.07	70.722.07	70.725.07	70.727.07				
2	70.710.08	70.712.08	70.715.08	70.717.08	70.720.08	70.722.08	70.725.08	70.727.08				
3	70.710.09	70.712.09	70.715.09	70.717.09	70.720.09	70.722.09	70.725.09	70.727.09				
4	70.710.11	70.712.11	70.715.11	70.717.11	70.720.11	70.722.11	70.725.11	70.727.11				
5	70.710.12	70.712.12	70.715.12	70.717.12	70.720.12	70.722.12	70.725.12	70.727.12				
6	70.710.14	70.712.14	70.715.14	70.717.14	70.720.14	70.722.14	70.725.14	70.727.14				
7					70.720.15	70.722.15	70.725.15	70.727.15				
8					70.720.16	70.722.16	70.725.16	70.727.16				
9					70.720.19	70.722.19	70.725.19	70.727.19				
10					70.720.20	70.722.20	70.725.20	70.727.20				
14									70.730.30	70.732.30	70.735.30	70.737.30
15									70.730.35	70.732.35	70.735.35	70.737.35
16									70.730.40	70.732.40	70.735.40	70.737.40