

Atrauma-Bulldogklemmen
 Atrauma Bulldog Clamps
 Clamps Bulldog Atrauma
 Clamps Atrauma Bulldog
 Pinze Atrauma Bulldog

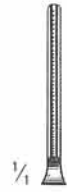

DE BAKEY
 12.092.07-12.093.12



12.092.07
 7,5 cm



12.092.08
 8,5 cm



12.092.10
 10,5 cm



12.092.12
 12 cm



12.093.07
 7 cm



12.093.08
 8 cm



12.093.10
 10 cm

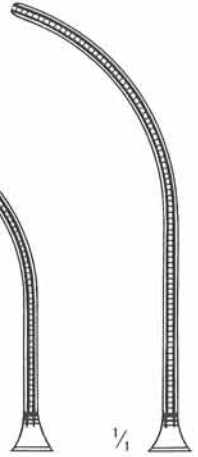

12.093.12
 11,5 cm

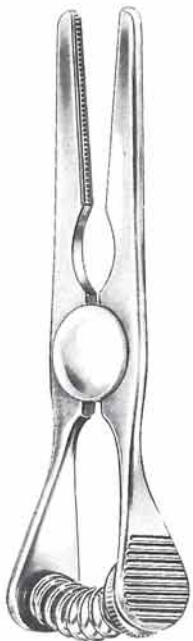

GLOVER
 12.096.06-12.097.11



12.096.06
 6 cm

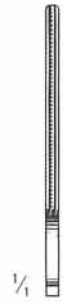

12.096.07
 7 cm

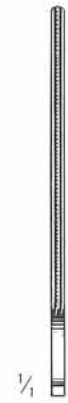

12.096.09
 9 cm



12.096.11
 11 cm



12.097.06
 5,5 cm



12.097.07
 6,5 cm



12.097.09
 8,5 cm

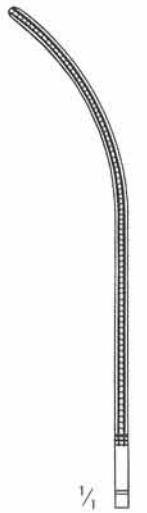

12.097.11
 10,5 cm

Arterienklemmen
 Hemostatic Forceps
 Pinces hémostatiques
 Pinzas hemostáticas
 Pinze emostatiche

Gefäßklemmen
 Serrefines
 Serre-fines
 Serra-finas
 Serrefine



cm	DIEFFENBACH		JOHNS-HOPKINS	
3,5	12.102.04	12.103.04		
5,0			12.110.50	12.111.50
5,5	12.102.05	12.103.05	12.110.55	12.111.55
6,5			12.110.65	12.111.65
7,0			12.110.70	12.111.70
7,5			12.110.75	12.111.75
9,0			12.110.90	12.111.90

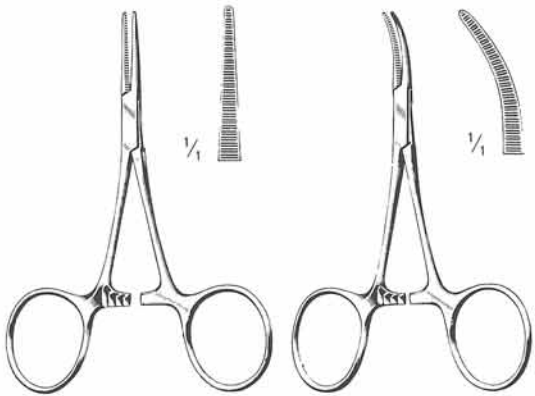

HARTMANN
 12.210.10 10 cm 12.211.10



HARTMANN
 12.212.10 10 cm 12.213.10

Titan
Titanium
Titane
Titano

Arterienklemmen
Hemostatic Forceps
Pinces hémostatiques
Pinzas hemostáticas
Pinze emostatiche

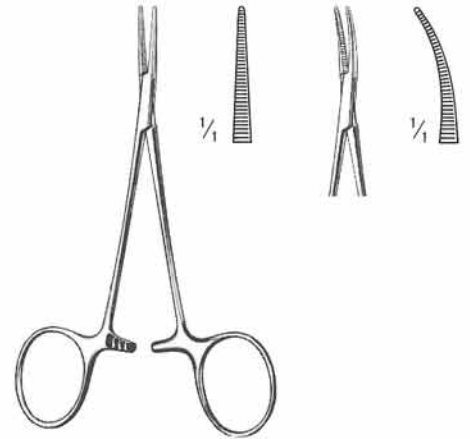
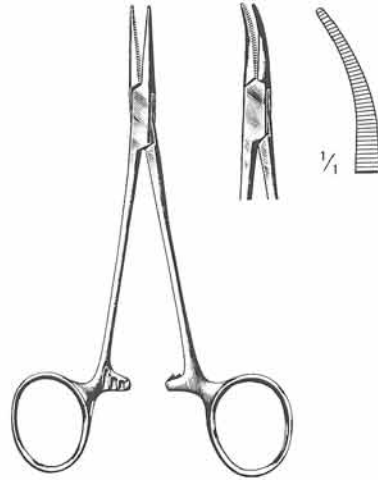

cm	— HALSTED - MOSQUITO —			— HALSTED-MOSQUITO micro —		
12,5	12.224.12	12.220.12	12.221.12	12.225.12	12.222.12	12.223.12
14,0		12.220.14	12.221.14			
18,0		12.220.18	12.221.18			
21,0		12.220.21	12.221.21			

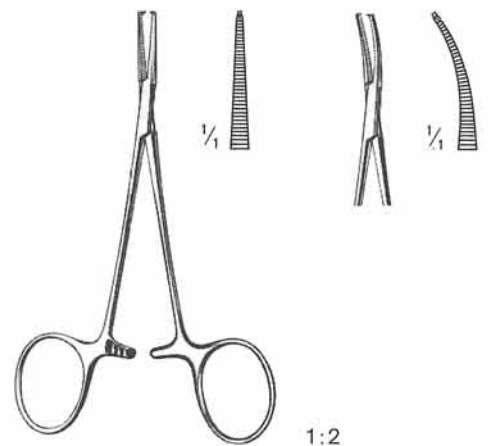
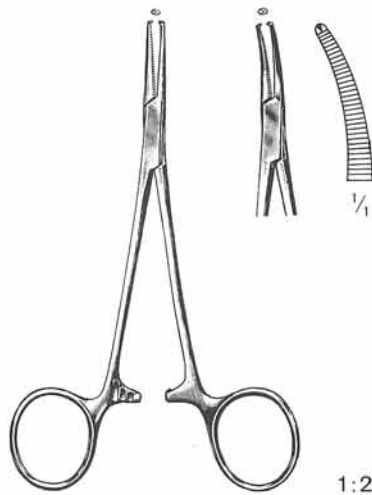

cm	— HALSTED - MOSQUITO — 1:2			— HALSTED - MOSQUITO micro — 1:2		
12,5	12.234.12	12.230.12	12.231.12	12.235.12	12.232.12	12.233.12
14,0		12.230.14	12.231.14			
18,0		12.230.18	12.231.18			
21,0		12.230.21	12.231.21			

Arterienklemmen
 Hemostatic Forceps
 Pinces hémostatiques
 Pinzas hemostáticas
 Pinze emostatiche

Titan
 Titanium
 Titane
 Titanio

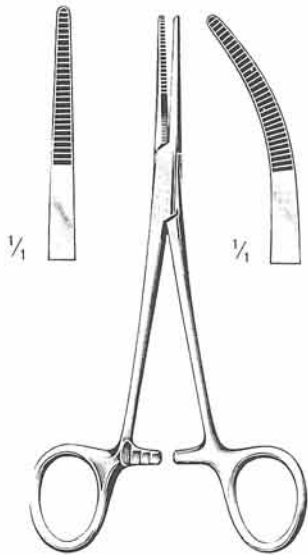

cm ——— KELLY ———
 14 12.240.14 12.241.14
 14 12.244.14 12.245.14
 16

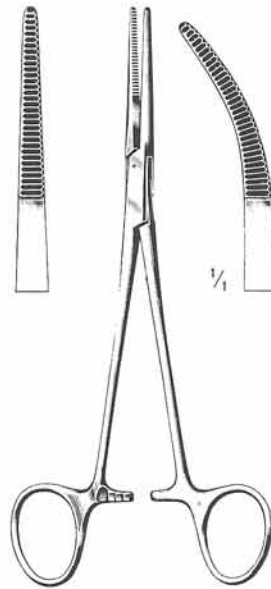

————— KELLY-RANKIN ———
 12.242.16 12.243.16

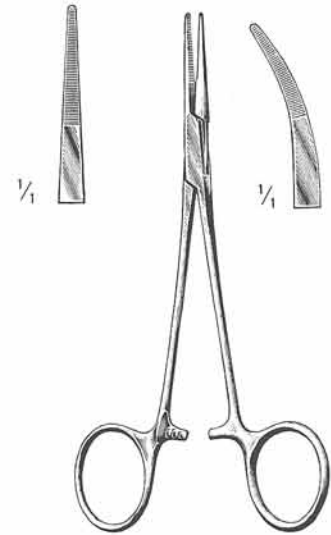

————— PROVIDENCE-HOSPITAL ———
 12.270.14 12.271.14

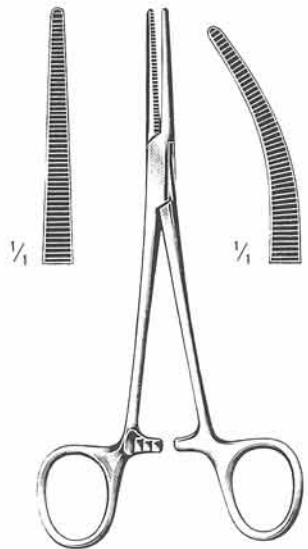

cm ——— CRILE ———
 14 12.250.14 12.251.14
 14 12.254.14 12.255.14
 16

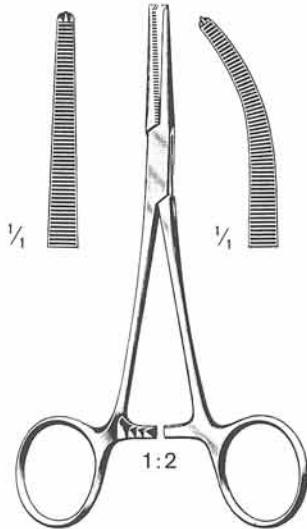

————— CRILE ———
 12.260.14 12.261.14

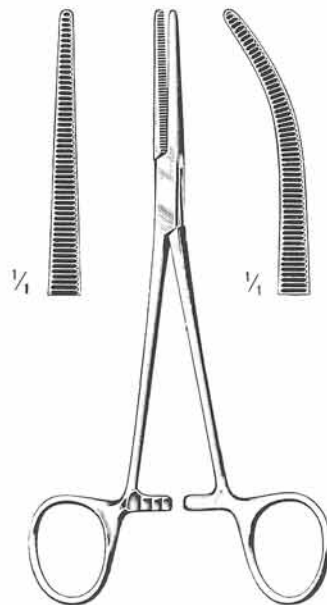

————— CRILE-RANKIN ———
 12.262.16 12.263.16

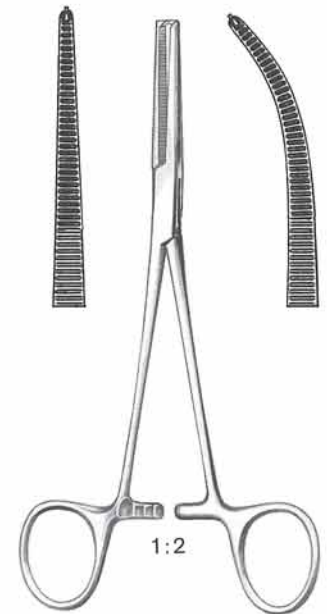

————— CRILE-RANKIN ———
 12.264.16 12.265.16

Arterienklemmen
Hemostatic Forceps
Pinces hémostatiques
Pinzas hemostáticas
Pinze emostatiche

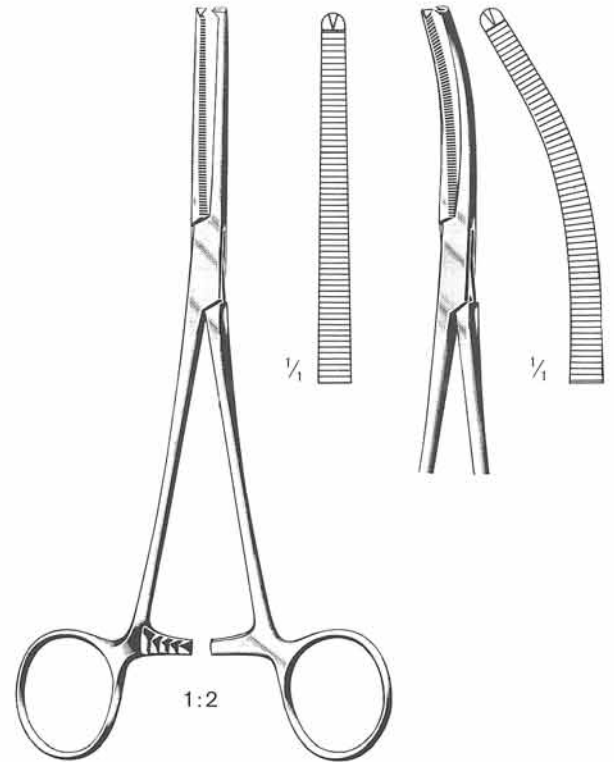
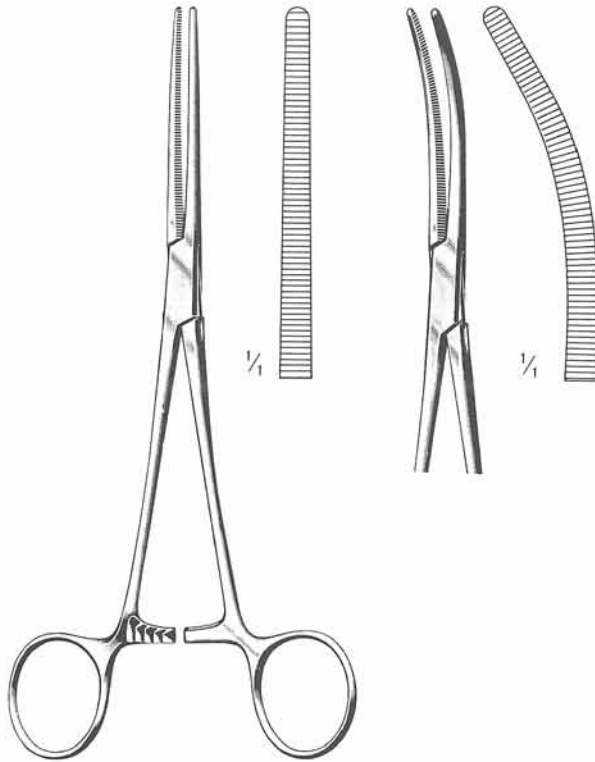

cm	ROCHESTER-PEAN		ROCHESTER-OCHSNER	
13	12.310.13	12.311.13	12.320.13	12.321.13
14	12.310.14	12.311.14	12.320.14	12.321.14
16	12.310.16	12.311.16	12.320.16	12.321.16
18	12.310.18	12.311.18	12.320.18	12.321.18
20	12.310.20	12.311.20	12.320.20	12.321.20
22	12.310.22	12.311.22	12.320.22	12.321.22
24	12.310.24	12.311.24	12.320.24	12.321.24
26	12.310.26	12.311.26	12.320.26	12.321.26
30	12.310.30	12.311.30	12.320.30	12.321.30

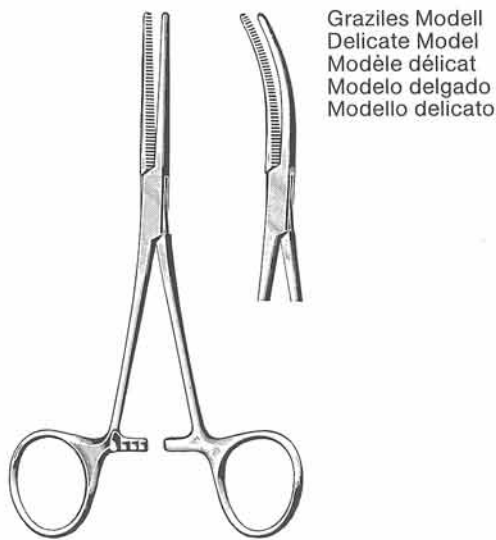

Graziles Modell
Delicate Model
Modèle délicat
Modelo delgado
Modello delicato

PEAN		
12.312.14	14 cm	12.313.14
12.312.16	16 cm	12.313.16

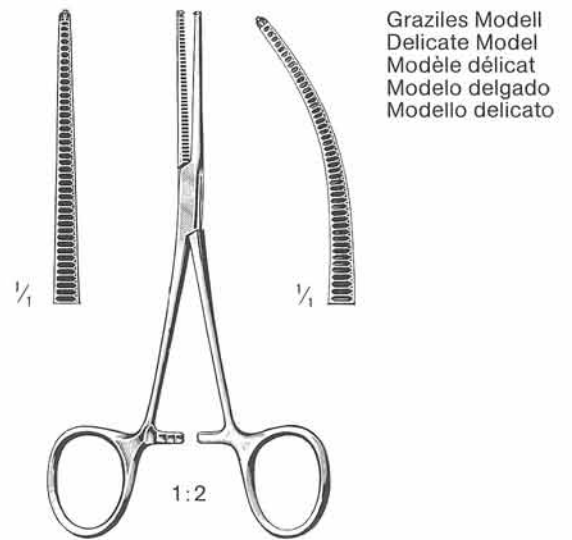

Graziles Modell
Delicate Model
Modèle délicat
Modelo delgado
Modello delicato

KOCHER		
12.322.14	14 cm	12.323.14
12.322.16	16 cm	12.323.16

Arterienklemmen
 Hemostatic Forceps
 Pinces hémostatiques
 Pinzas hemostáticas
 Pinze emostatiche

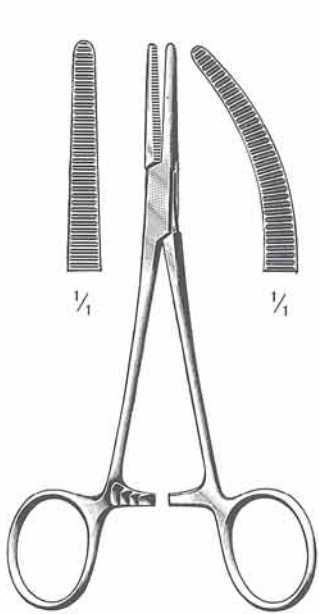

SPENCER-WELLS

12.330.13	13 cm	12.331.13
12.330.15	15 cm	12.331.15
12.330.18	18 cm	12.331.18
12.330.20	20 cm	12.331.20

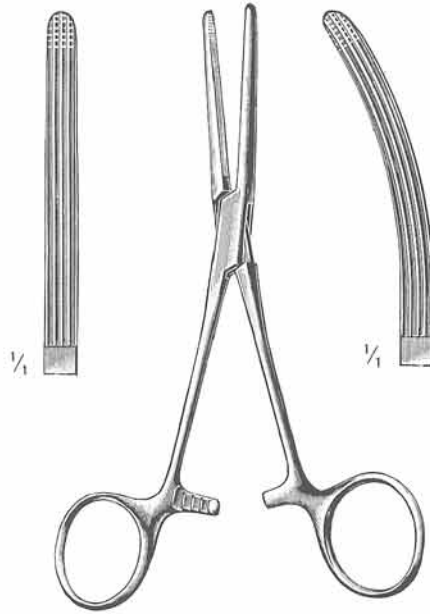

ROCHESTER-CARMALT

12.340.16	16 cm	12.341.16
12.340.20	20 cm	12.341.20

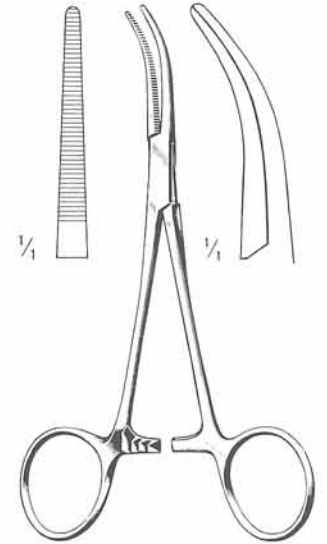

DANDY
 12.345.14
 14 cm

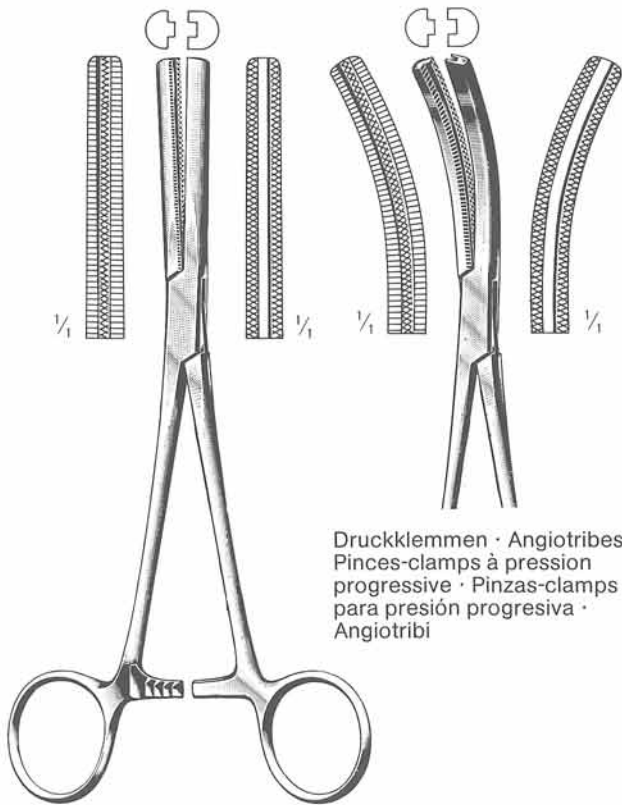

Druckklemmen · Angiotribes
 Pinces-clamps à pression
 progressive · Pinzas-clamps
 para presión progresiva ·
 Angiotribi

FERGUSSON

12.350.16	16 cm	12.351.16
12.350.20	20 cm	12.351.20

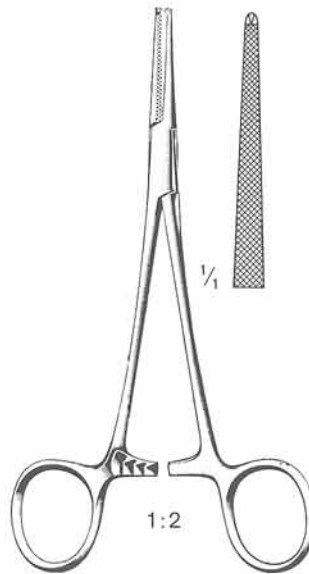

LOVELACE
 12.356.15
 15,5 cm

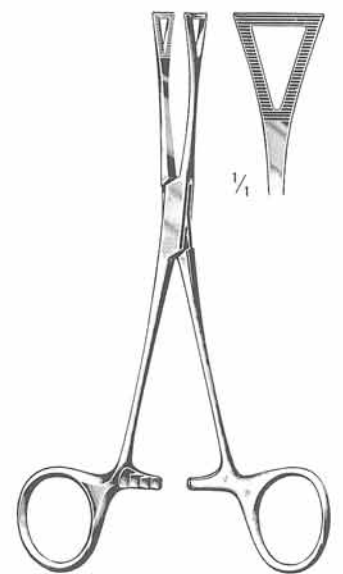

cm PENNINGTON

15,5	12.358.15
20,0	12.358.20

Arterienklemmen
 Hemostatic Forceps
 Pinces hémostatiques
 Pinzas hemostáticas
 Pinze emostatiche

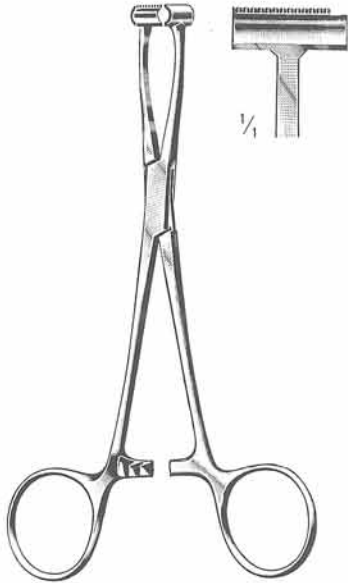

PRATT
 12.360.15
 15 cm

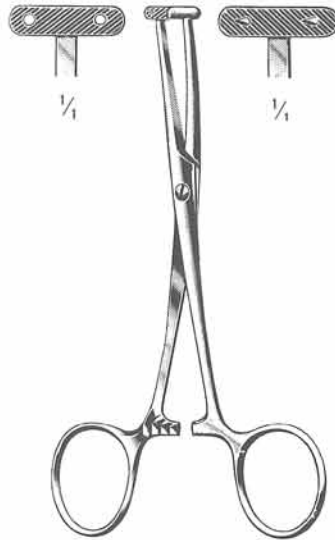

MARTEL
 12.364.14
 14 cm



WILLET-MARTEL
 12.366.19
 19 cm

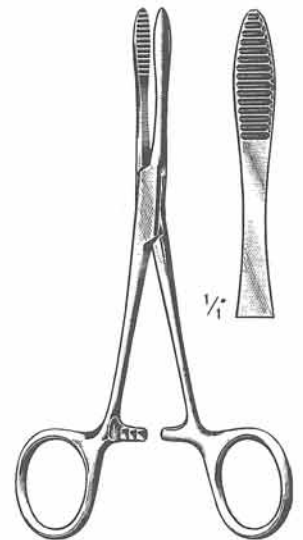

cm	PEAN
14	12.368.14
16	12.368.16

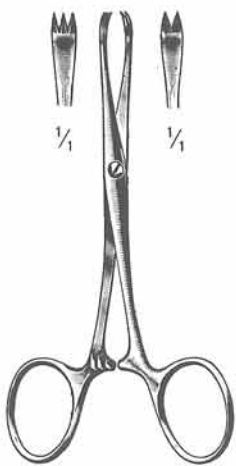

CHAPUT
 12.370.13
 13 cm

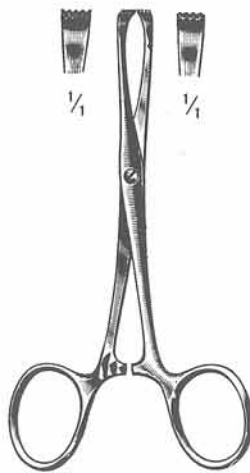

TUFFIER
 12.372.13
 13 cm

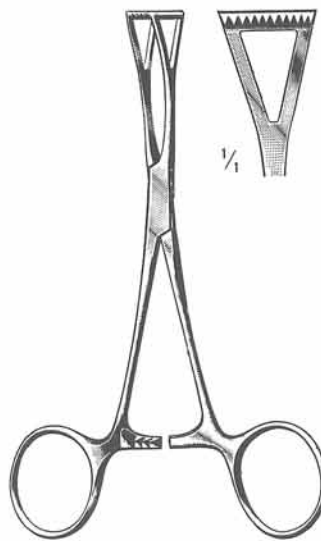

COLLIN
 12.374.14
 14 cm

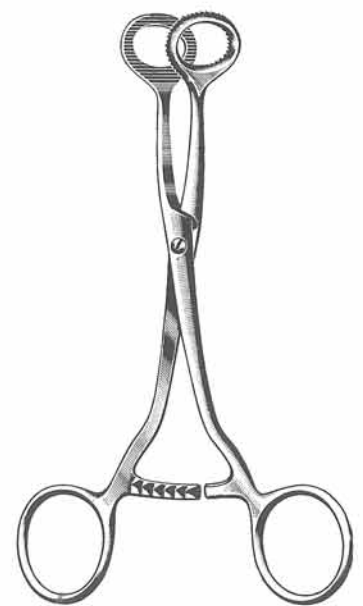

COLLIN
 12.376.16
 16 cm

Arterienklemmen
 Hemostatic Forceps
 Pinces hémostatiques
 Pinzas hemostáticas
 Pinze emostatiche

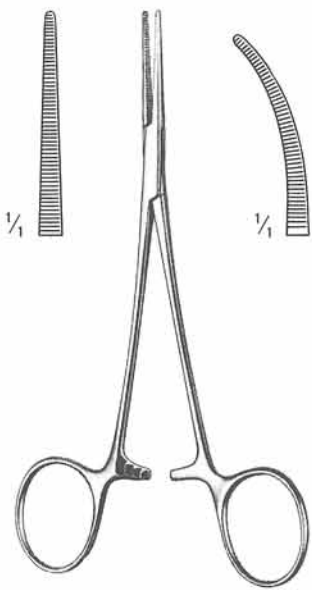

LERICHE
 12.380.15 15cm 12.381.15

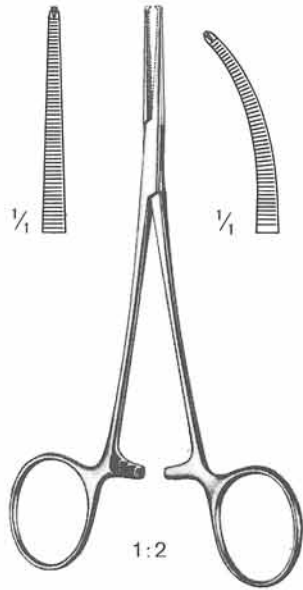

LERICHE
 12.382.15 15cm 12.383.15

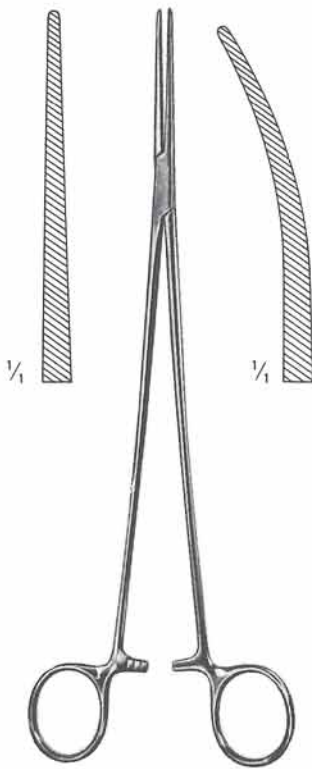

BENGOLEA
 12.384.20 20 cm 12.385.20
 12.384.26 26 cm 12.385.26

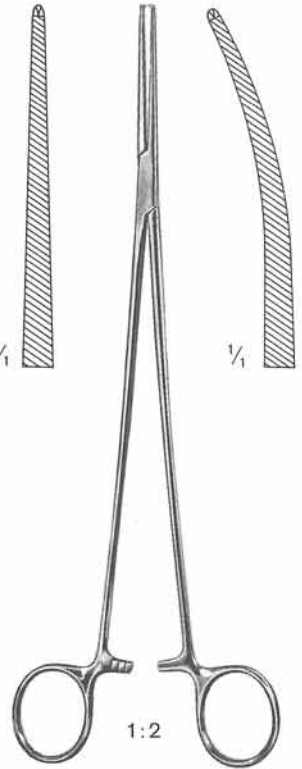

BENGOLEA
 12.386.20 20 cm 12.387.20
 12.386.26 26 cm 12.387.26

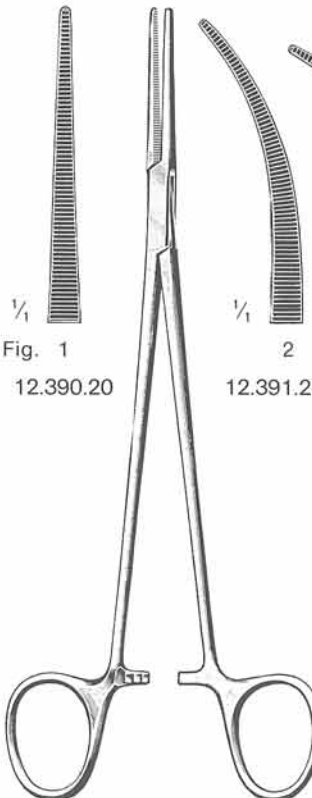
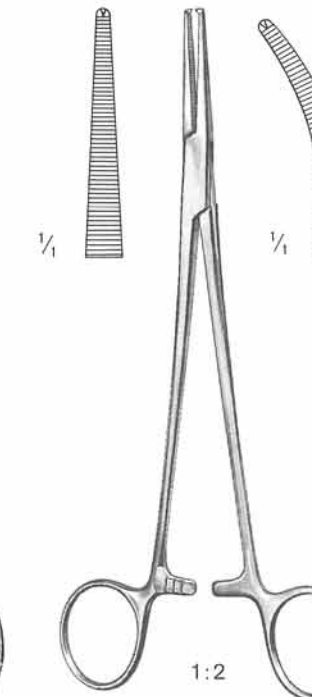

Fig. 1
 12.390.20

HEISS
 20 cm



ADSON
 12.410.18 18,5cm 12.411.18



ADSON
 12.412.18 18,5 cm 12.413.18



ADSON Baby
 12.415.18

Arterienklemmen
 Hemostatic Forceps
 Pincès hémostatiques
 Pinzas hemostáticas
 Pinze emostatiche

Präparier- und Ligaturklemmen
 Dissecting and Ligature Forceps
 Pincès à dissection et à ligatures
 Pinzas para disección y ligaduras
 Pinze per dissezione e per legature (Passafili)

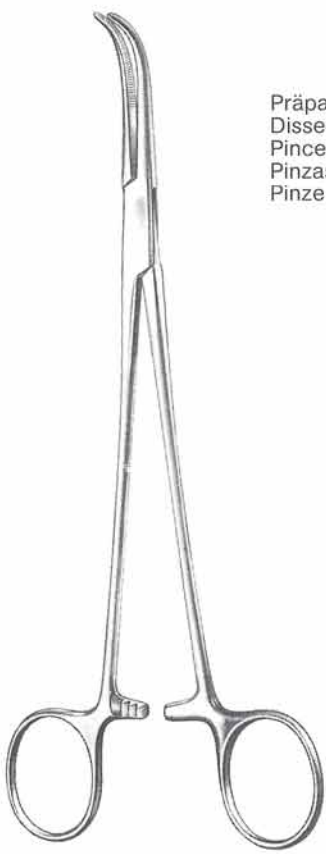

OVERHOLT-GEISSENDOERFER
 12.421.01 - 12.427.08

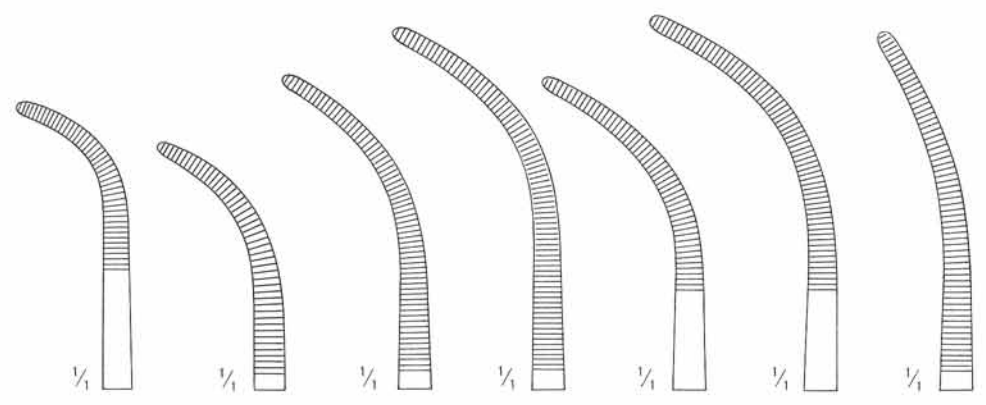

cm	Fig. 1	Fig. 2	Fig. 3	Fig. 4	Fig. 5	Fig. 6	Fig. 7
21	12.421.01	12.421.02	12.421.03	12.421.04	12.421.05	12.421.06	12.421.07
27	12.427.01	12.427.02	12.427.03	12.427.04	12.427.05	12.427.06	12.427.07



GEMINI
 GEMINI mini

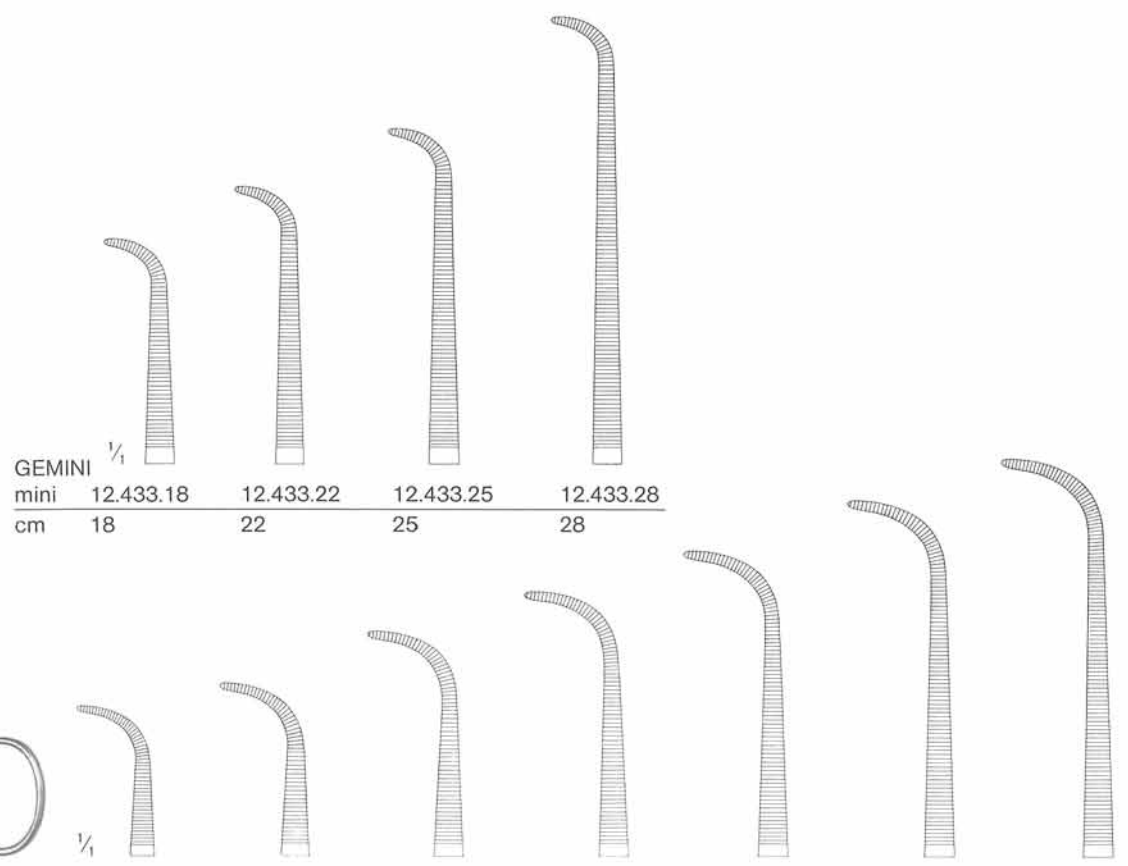

GEMINI mini	12.433.18	12.433.22	12.433.25	12.433.28
cm	18	22	25	28

GEMINI	12.431.13	12.431.16	12.431.18	12.431.20	12.431.23	12.431.25	12.431.28
cm	13 cm	16 cm	18 cm	20 cm	23 cm	25 cm	28 cm

Arterienklemmen
 Hemostatic Forceps
 Pinces hémostatiques
 Pinzas hemostáticas
 Pinze emostatiche

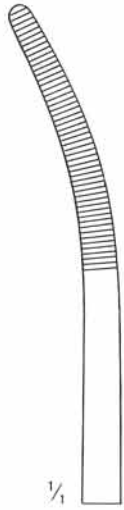

12.441.01

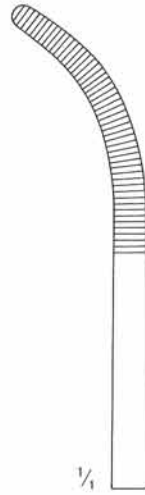

12.441.02

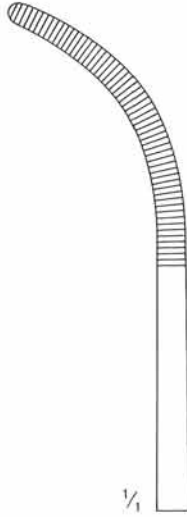

12.441.03



12.441.04



RUMEL
 12.441.01 - 12.441.04
 23 cm



12.442.21 21 cm
 12.442.26 26 cm



21 cm 12.443.21
 26 cm 12.443.26



12.444.21 21 cm
 12.444.26 26 cm



21 cm 12.445.21
 26 cm 12.445.26



TOENNIS
 12.442.21 - 12.445.26
 21 cm 26 cm

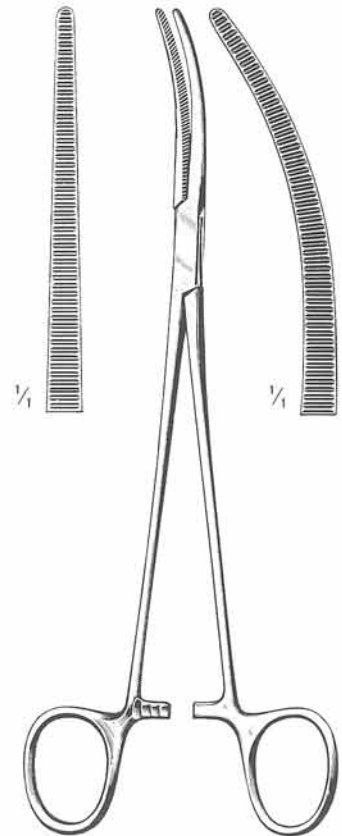

ROBERTS
 12.448.22 22 cm 12.449.22

Arterienklemmen
 Hemostatic Forceps
 Pinces hémostatiques
 Pinzas hemostáticas
 Pinze emostatiche

Bronchusklemmen
 Bronchus Forceps
 Pinces-Clamps à Bronches
 Pinzas clamps bronquiales
 Pinze per bronchi

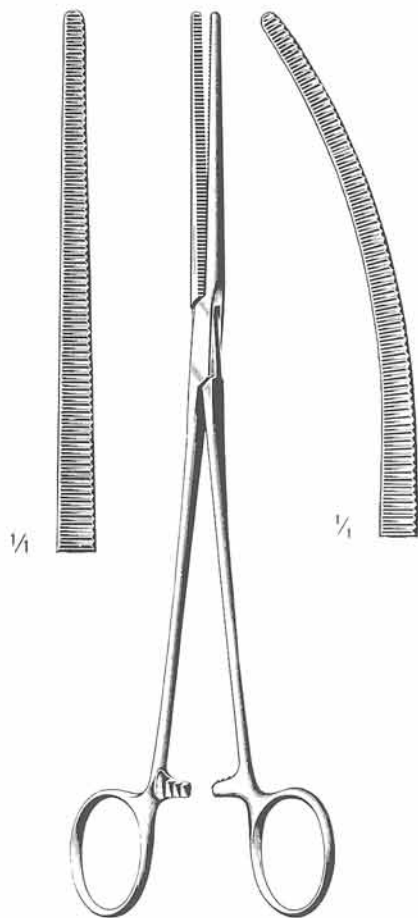

SAROT
 12.450.24 24 cm 12.451.24

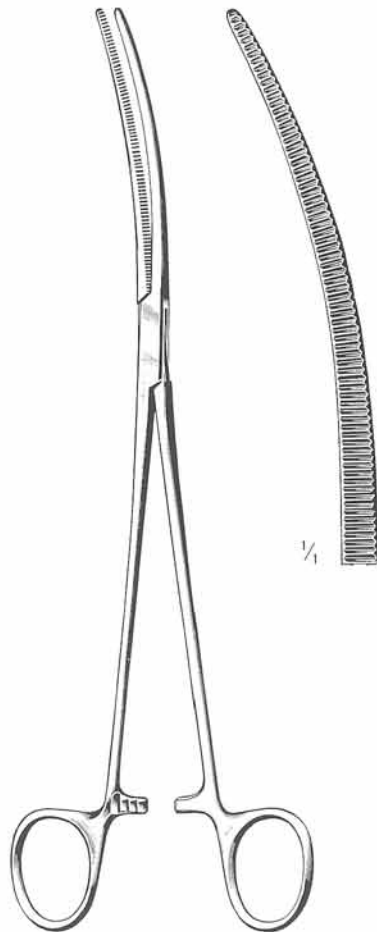

CRAFOORD
 12.453.24
 24 cm

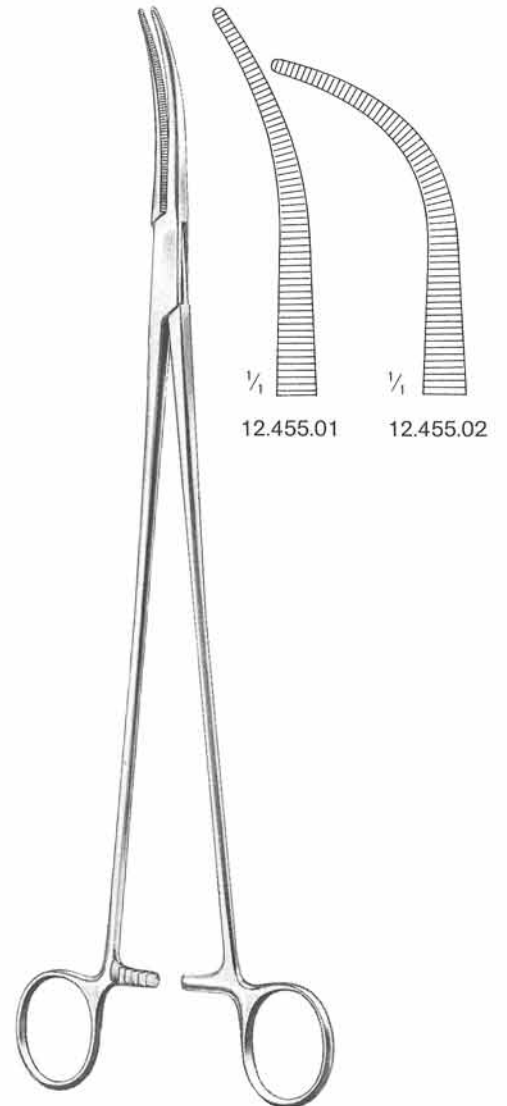

ZENKER
 12.455.01 - 12.455.02
 29,5 cm

Arterienklemmen
 Hemostatic Forceps
 Pinces hémostatiques
 Pinzas hemostáticas
 Pinze emostatiche

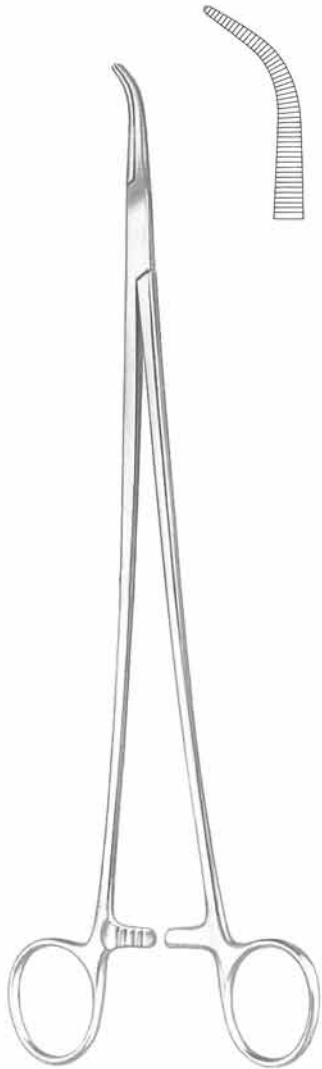

LAWRENCE
 12.457.28
 28 cm

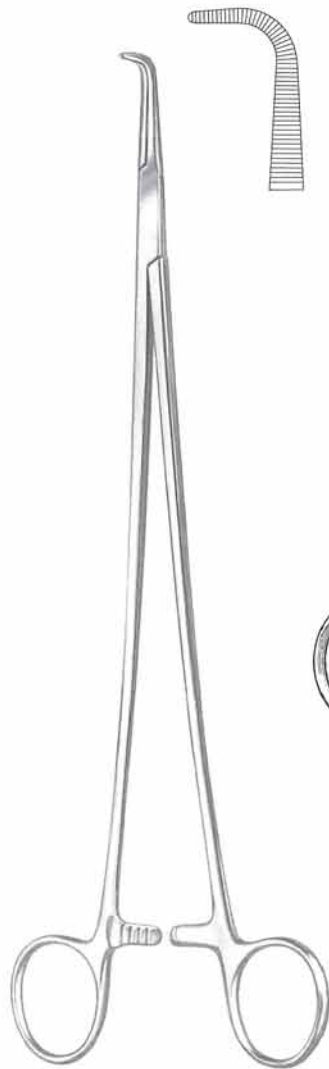

MEEKER
 12.459.28
 28 cm

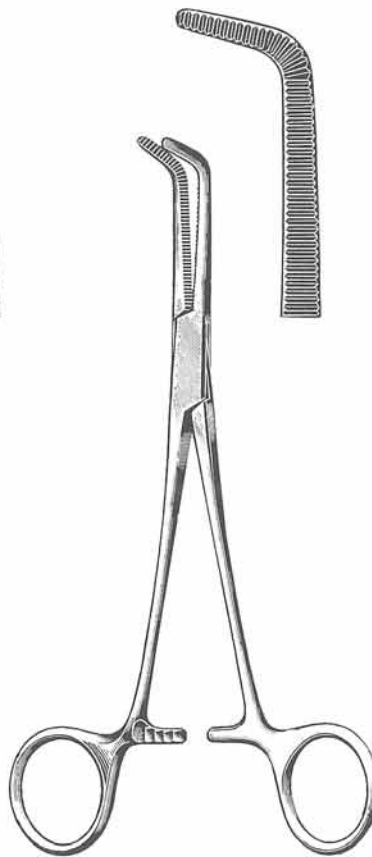

cm	MIXTER
14	12.471.14
16	12.471.16
18	12.471.18
23	12.471.23

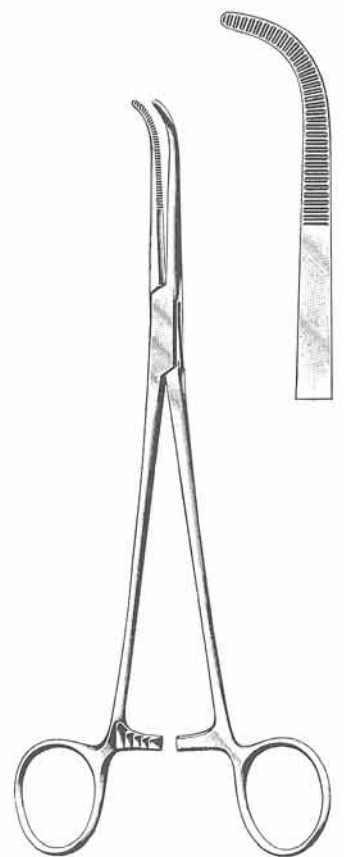

MIXTER
 12.473.22
 22 cm

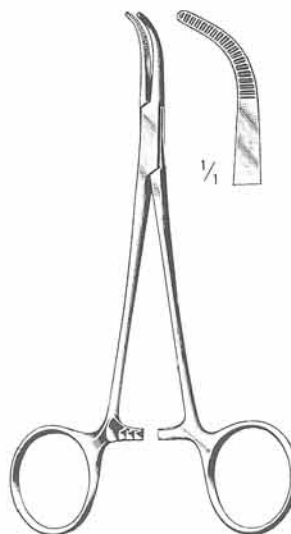

MIXTER Baby
 12.475.14
 14 cm



MIXTER Baby
 12.475.18
 18 cm

Arterien, Gallenkanal, Nierenstiel
 Hemostatic, Gall Duct, and Kidney Pedicle
 Hémostatiques, pédicule rénal et voies biliaires
 Hemostáticas, pedículo renal y vías biliares
 Emostatiche, peduncolo renale e vie biliari

Arterienklemmen
 Hemostatic Forceps
 Pinces hémostatiques
 Pinzas hemostáticas
 Pinze emostatiche

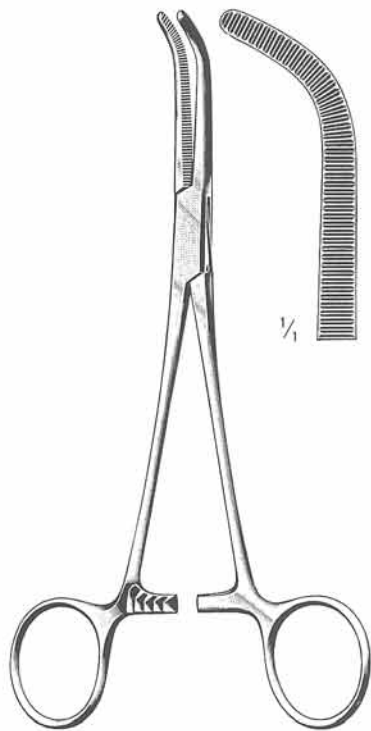

cm	MIXTER-O'SHAUGNESSY
15,5	12.477.15
19,0	12.477.19

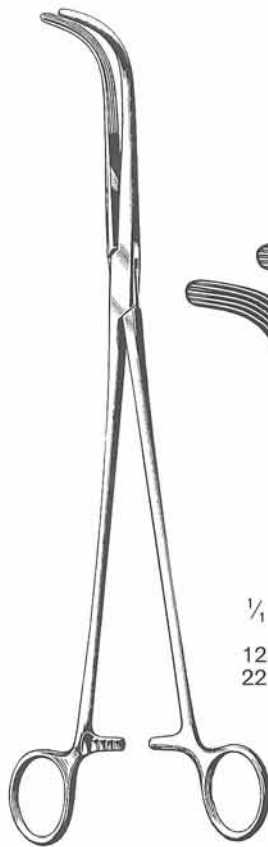

MIXTER
 12.479.22 - 12.479.28

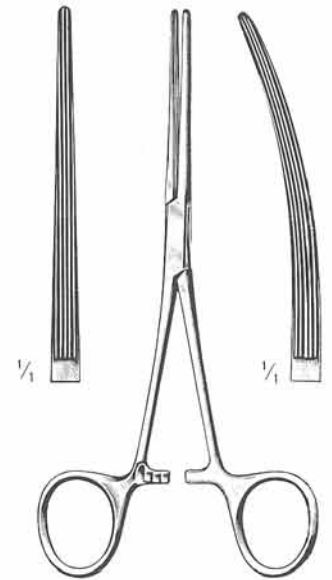
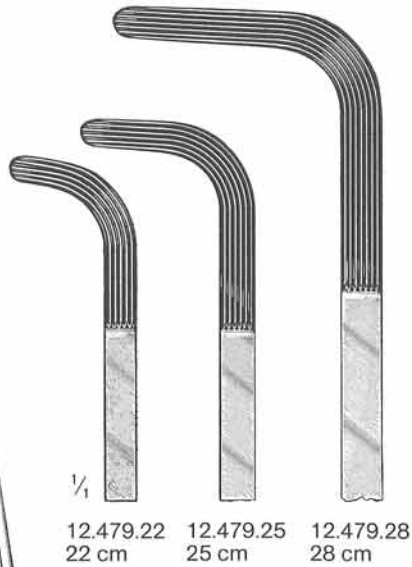

BAINBRIDGE		
12.480.15	15,0 cm	12.481.15
12.480.18	18,5 cm	12.481.18

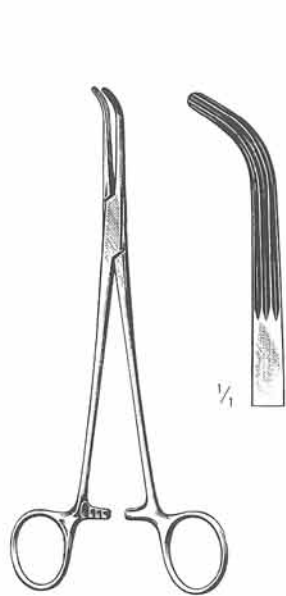

LAHEY
 12.491.19
 19 cm

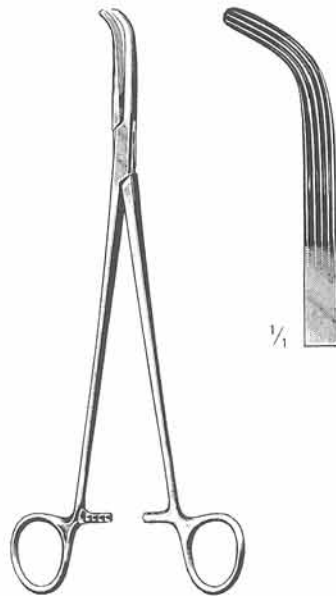

LAHEY
 12.493.23
 23 cm



LOWER
 12.495.18
 18 cm

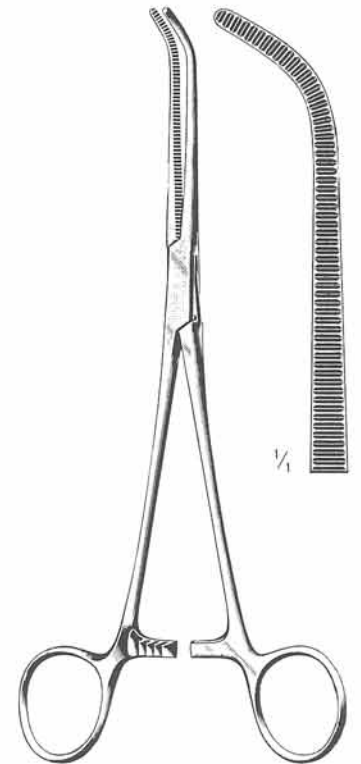

JOHNS-HOPKINS
 12.497.20
 20 cm

Arterienklemmen
 Hemostatic Forceps
 Pinces hémostatiques
 Pinzas hemostáticas
 Pinze emostatiche

Gallenkanal · Gall Duct ·
 Voies biliaires · Vías
 biliares · Vie biliari



MIXTER
 12.499.16
 16,5 cm

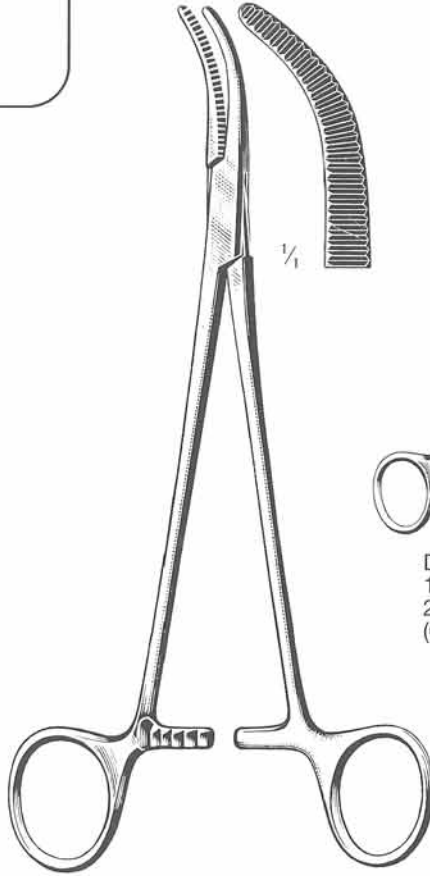

MOYNIHAN
 12.501.23
 23 cm

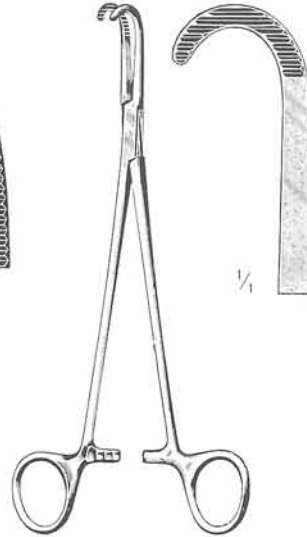

DESJARDINS
 12.503.21
 21 cm
 (Cysticus)

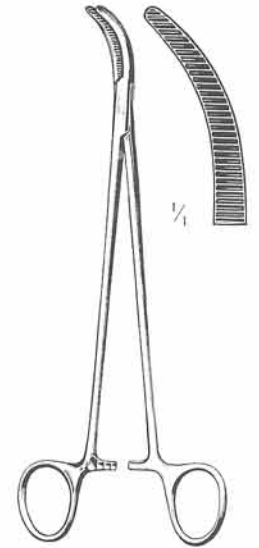

DESJARDINS
 12.505.21
 21 cm

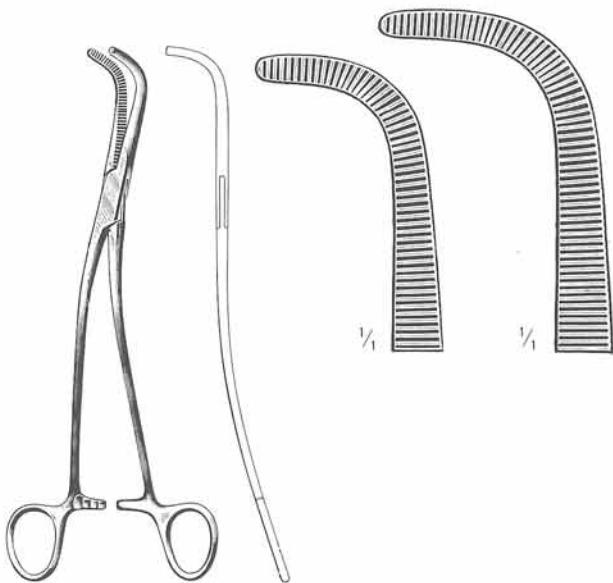

GRAY
 Cholecystectomie
 12.507.22 12.507.23
 22 cm 23 cm

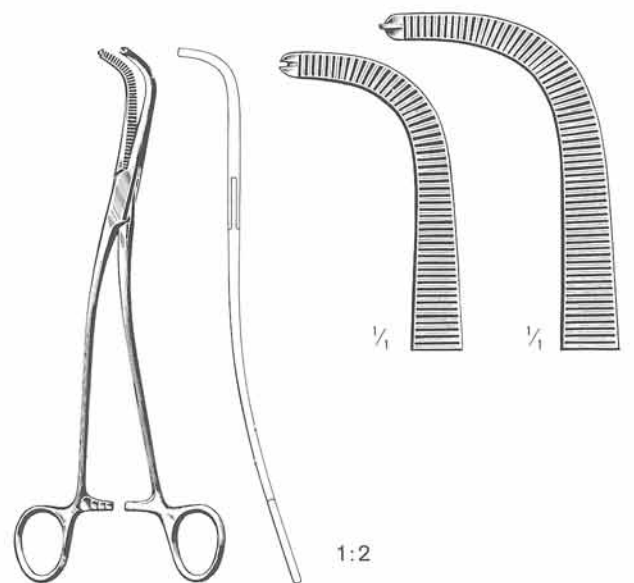

GRAY
 12.509.22 12.509.23
 22 cm 23 cm

Arterienklemmen
 Hemostatic Forceps
 Pincès hémostatiques
 Pinzas hemostáticas
 Pinze emostatiche

Nierenstiel, Gallenkanal
 Kidney Pedicle, Gall Duct
 Pédicule rénal, conduit biliaire
 Pediculo renal, vías biliares
 Pedunculo renale, vie biliari

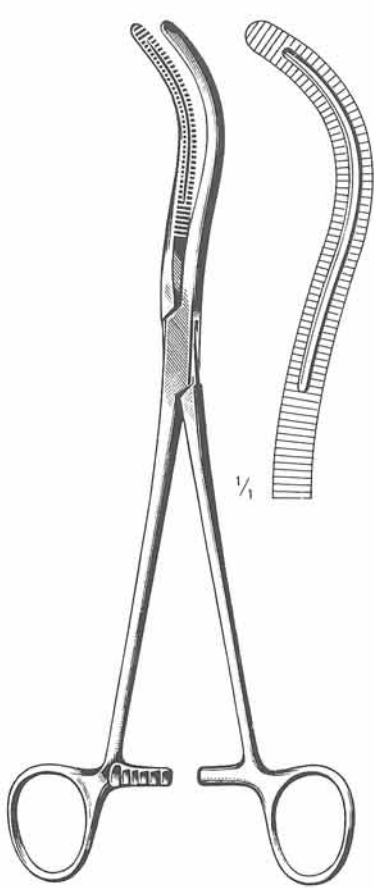

STILLE
 12.513.23
 23 cm

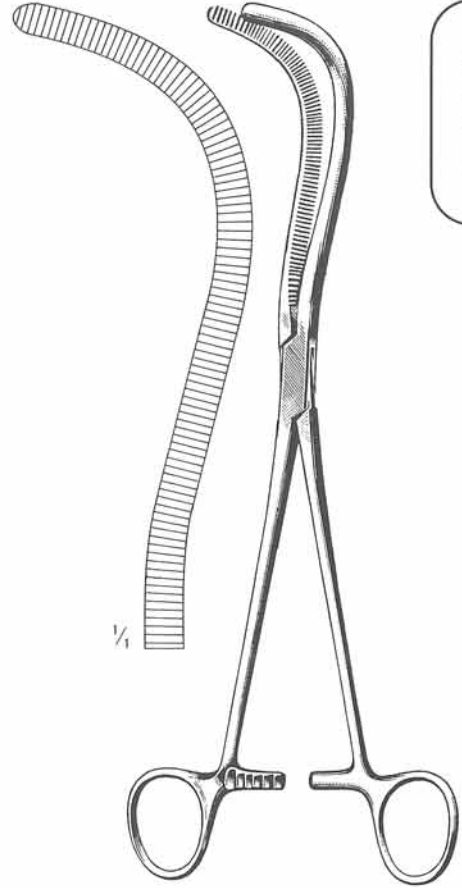

MAYO-GUYON
 12.515.23
 23 cm

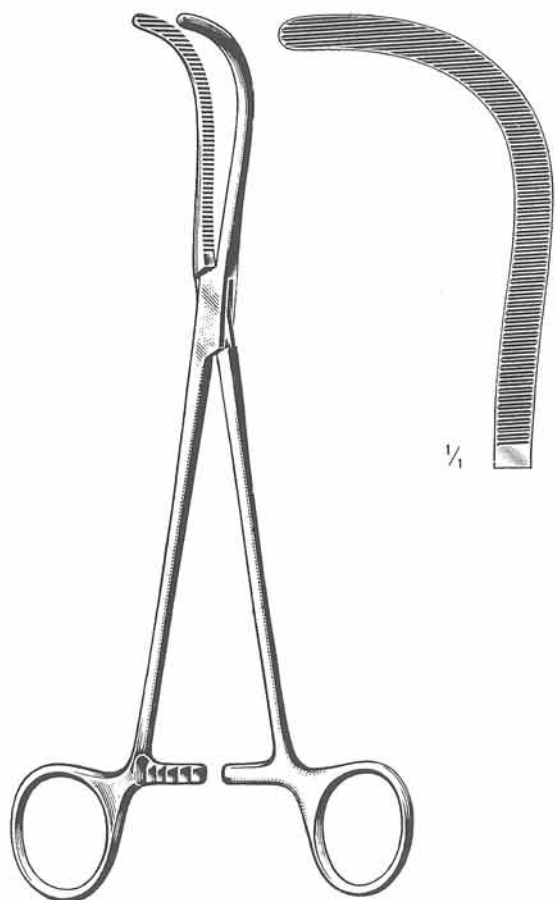

GUYON
 12.517.23
 23 cm

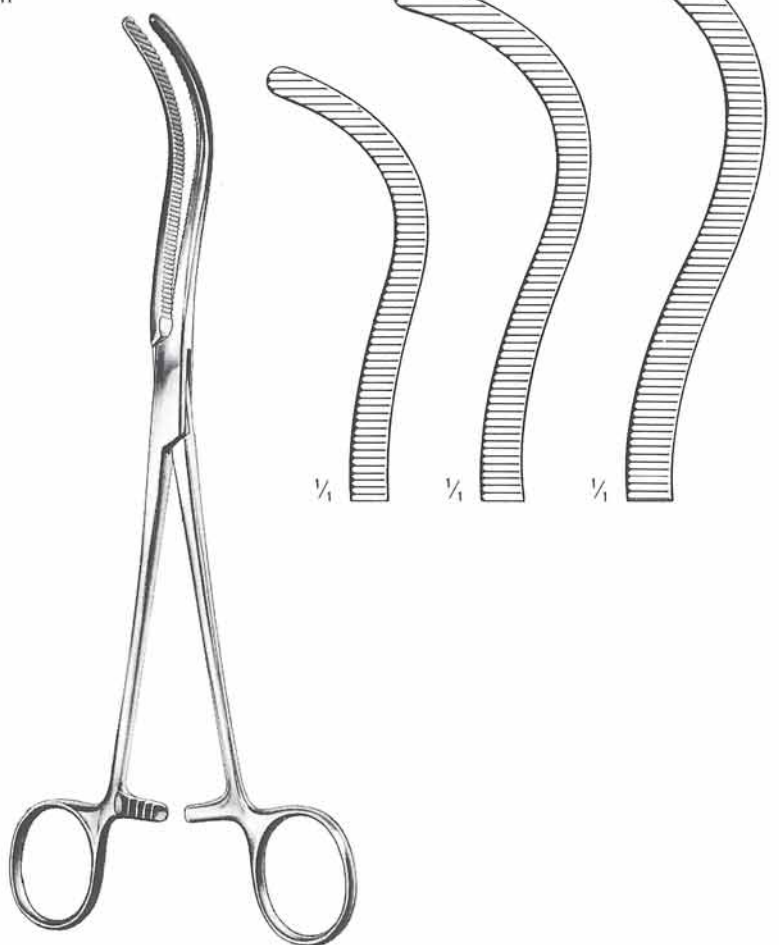

GUYON

12.519.20
 20 cm

12.519.22
 22 cm

12.519.24
 24 cm

Arterienklemmen
 Hemostatic Forceps
 Pinces hémostatiques
 Pinzas hemostáticas
 Pinze emostatiche

Nierenstiel
 Kidney Pedicle
 Pédicule rénal
 Pedículo renal
 Pedunculo renale

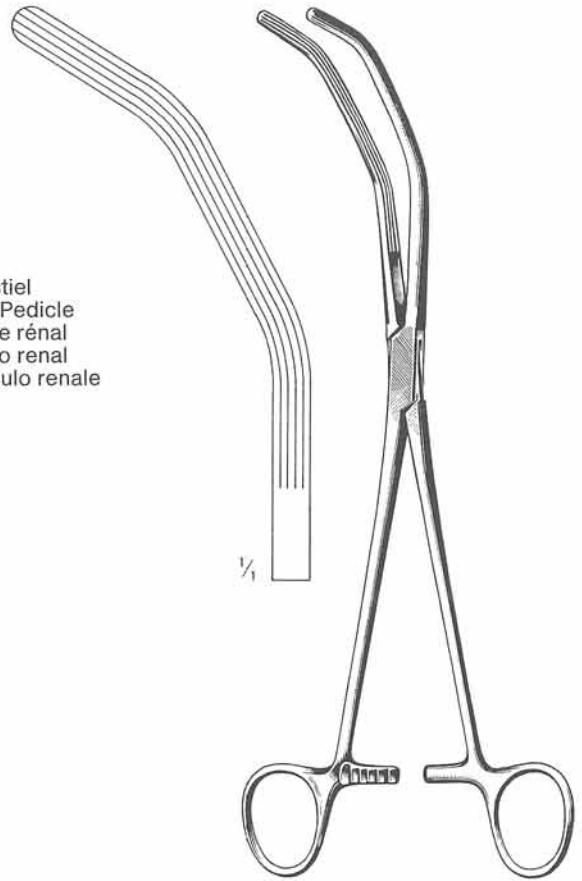

HERRICK
 12.523.23
 23 cm

Peritoneum-Klemmen
 Peritoneum Forceps
 Pinces à péritoine
 Pinzas para peritoneo
 Pinze peritoneali

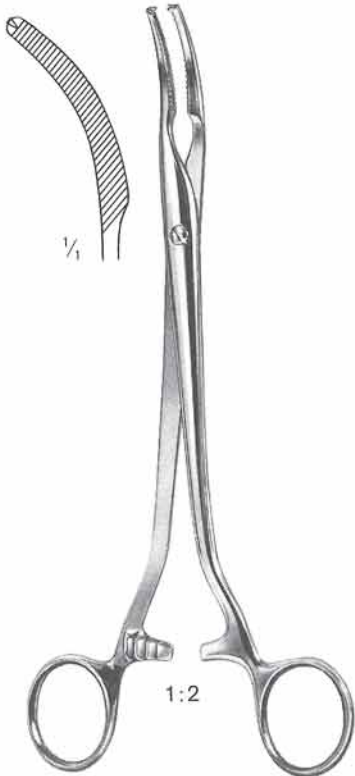

MIKULICZ
 12.551.20
 20 cm

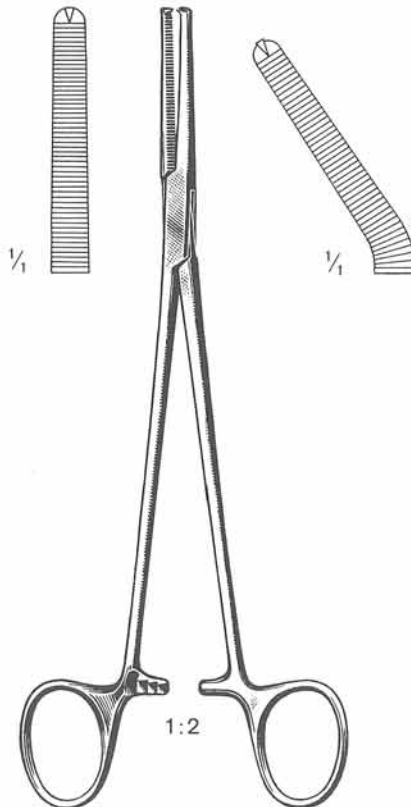

PHANEUF
 12.554.21 21 cm 12.555.21

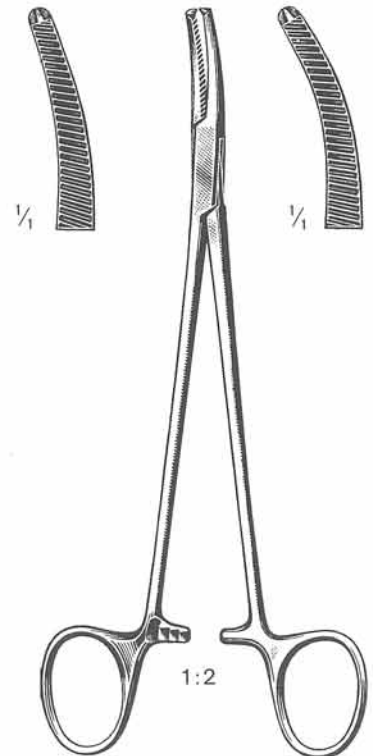

FAURE
 12.561.20 20 cm 12.563.20

Hysterektomie-Klemmen
 Hysterectomy Forceps
 Pincès à hysterectomie
 Pinzas para hysterectomía
 Pinze per isterectomia

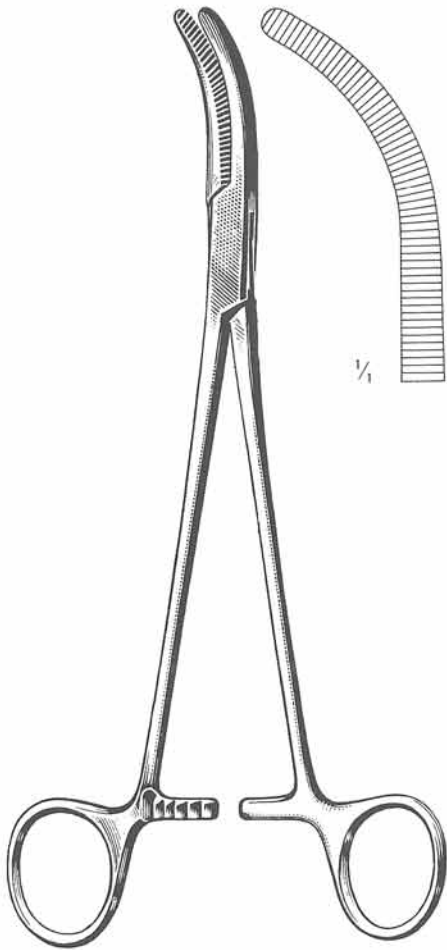

WERTHEIM
 12.571.25
 25 cm

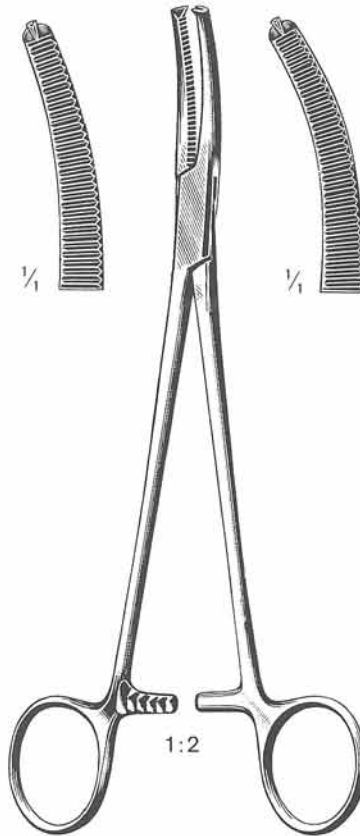

WERTHEIM		
12.573.22	22 cm	12.575.23
	23 cm	

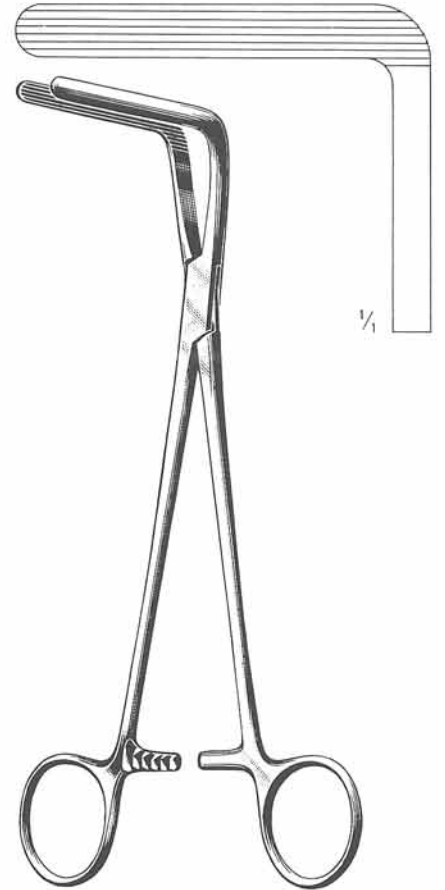

WERTHEIM-CULLEN
 12.579.21
 21,5 cm

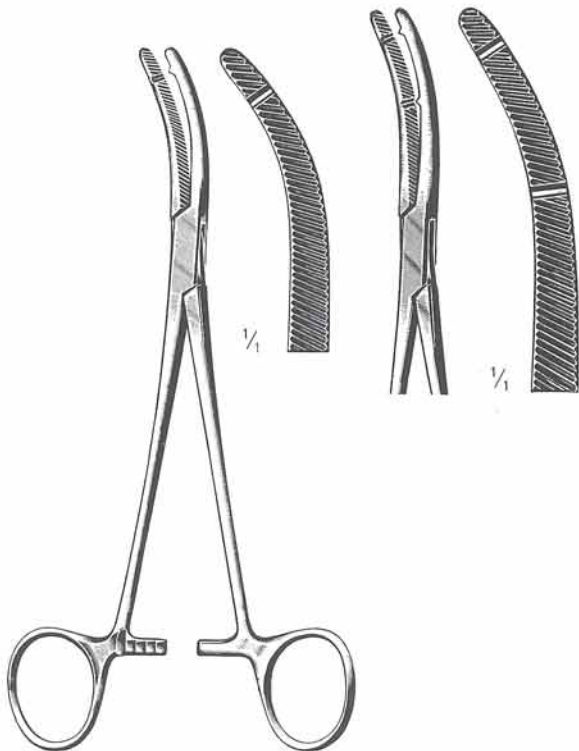

HEANEY		
20 cm	12.591.20	12.593.20

Schlauchklemmen
 Tubing Clamps
 Pincas serre-tubes
 Pinzas cierra-tubos
 Pinze serretubi

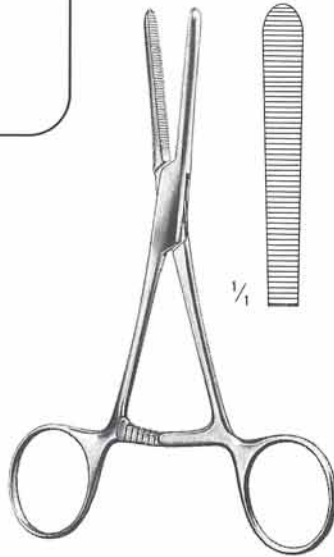

WEISS
 12.702.14
 14,5 cm

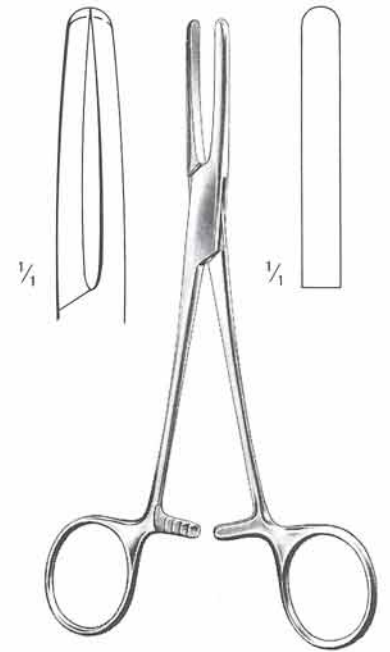

PRESBYTERIAN HOSPITAL
 12.704.16 16 cm
 12.704.18 18 cm

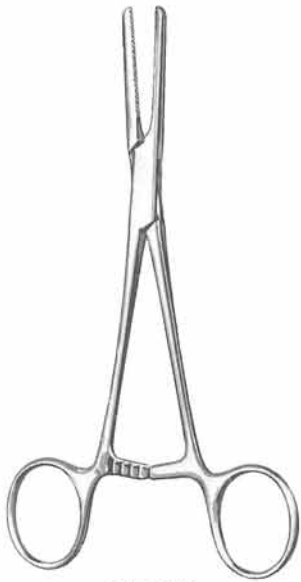

MURPHY
 12.710.15 - 12.710.20



12.710.15
 15 cm



12.710.18
 18 cm

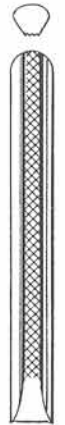

12.710.20
 20 cm



12.712.15 - 12.712.20

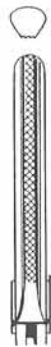

12.712.15
 15 cm



12.712.18
 18 cm

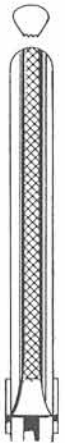

12.712.20
 20 cm