

Kehlkopf  
 Larynx  
 Larynx  
 Laringe  
 Laringe

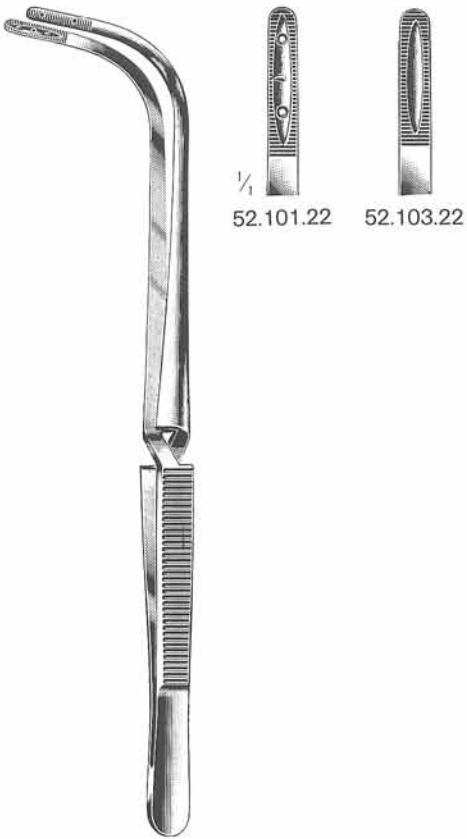

1/4  
 52.101.22    52.103.22

JACKSON  
 52.101.22-52.103.22  
 22 cm

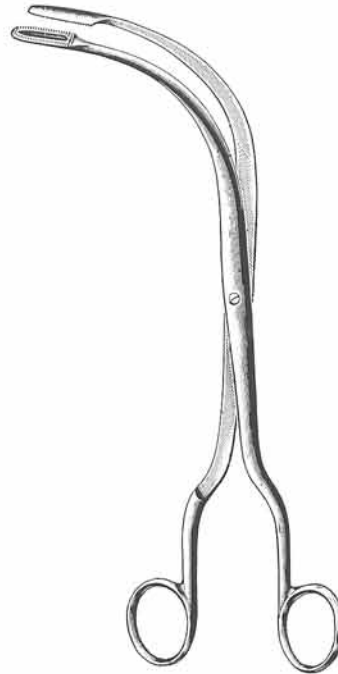

FRAENKEL  
 52.111.18  
 18 cm

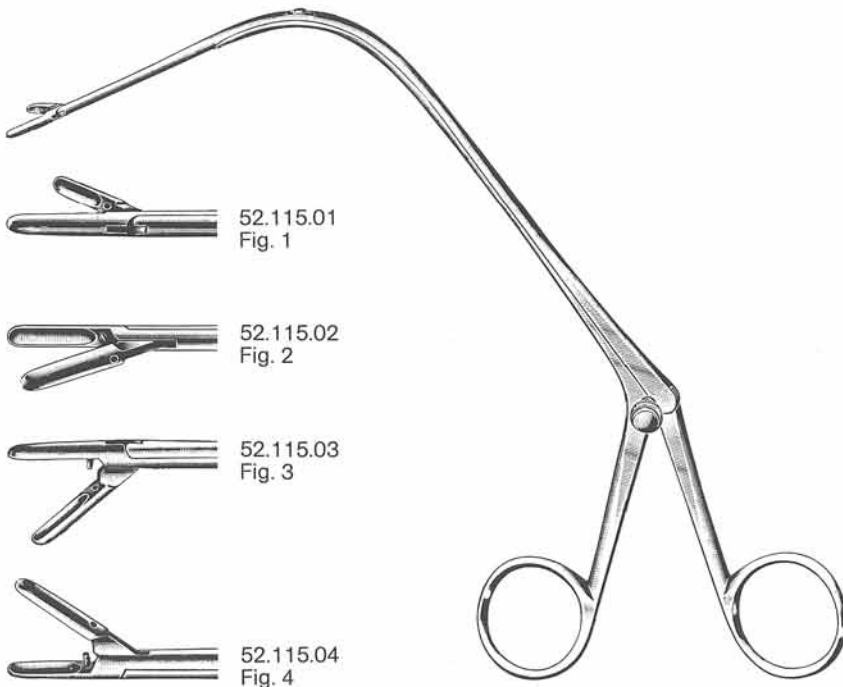

52.115.01  
 Fig. 1

52.115.02  
 Fig. 2

52.115.03  
 Fig. 3

52.115.04  
 Fig. 4

JURASZ  
 52.115.01-52.115.04  
 23 cm

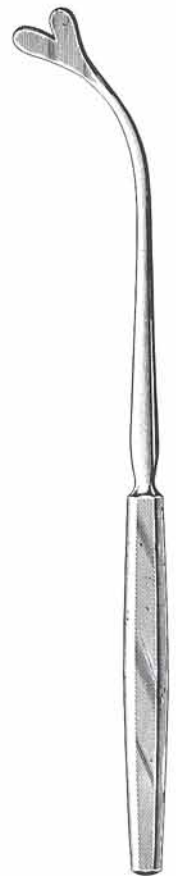

REICHERT  
 52.121.24  
 24 cm

Kehlkopf  
Larynx  
Larynx  
Laringe  
Laringe

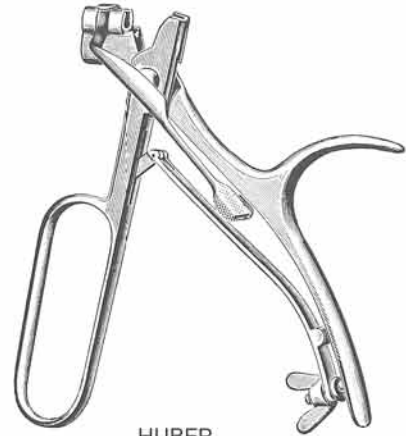

HUBER  
52.130.00



cm	BRUENINGS
20	52.132.20
30	52.132.30
40	52.132.40
50	52.132.50
60	52.132.60

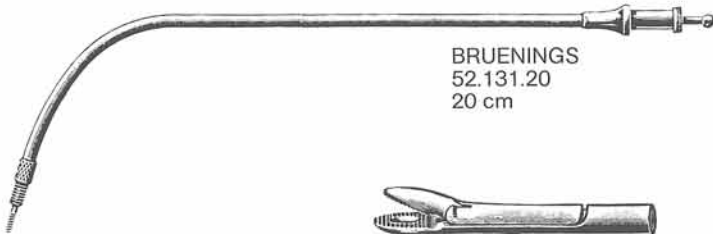

BRUENINGS  
52.131.20  
20 cm



FRAENKEL  
52.150.00



SEIFFERT  
52.152.00



FRAENKEL  
52.154.00



SCHEINMANN  
52.155.00



SCHEINMANN  
52.157.00



BRUENINGS  
52.158.02-52.158.03



BRUENINGS  
52.160.02-52.160.03

- 52.158.02
- 52.158.03

- 52.160.02
- 52.160.03



LANGE  
52.162.00

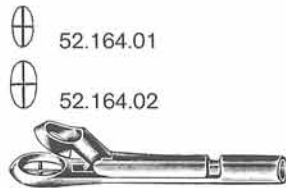

KRAUSE  
52.164.01-52.164.02



KRAUSE  
52.166.00

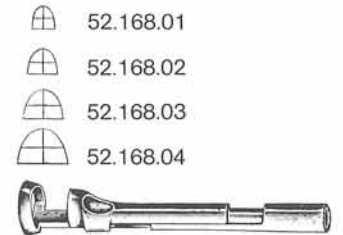

CORDES  
52.168.01-52.168.04

- ⊕ 52.168.01
- ⊕ 52.168.02
- ⊕ 52.168.03
- ⊕ 52.168.04



SCHUMACHER  
52.170.00

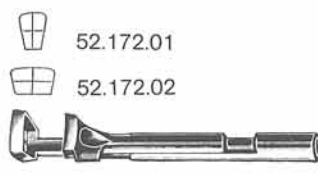

CORDES  
52.172.01-52.172.02

- ⊕ 52.172.01
- ⊕ 52.172.02



CORDES  
52.174.00



ROSENBERG  
52.176.00

Kehlkopf  
Larynx  
Larynx  
Larynge  
Larynge

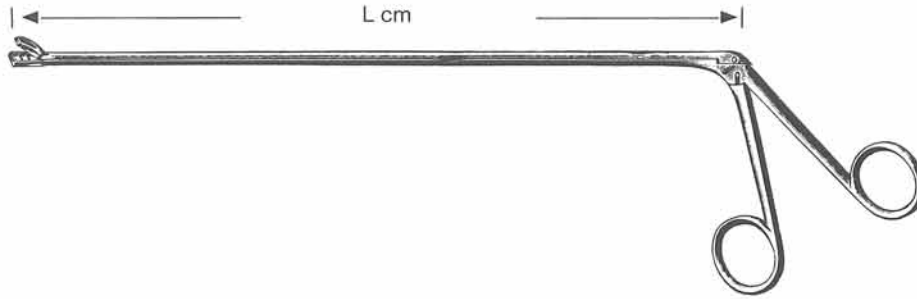

CHEVALIER-JACKSON  
52.230.01-52.260.07

cm	Fig. 1	Fig. 2	Fig. 3	Fig. 4	Fig. 5	Fig. 6	Fig. 7
30	52.230.01	52.230.02	52.230.03	52.230.04	52.230.05	52.230.06	52.230.07
40	52.240.01	52.240.02	52.240.03	52.240.04	52.240.05	52.240.06	52.240.07
50	52.250.01	52.250.02	52.250.03	52.250.04	52.250.05	52.250.06	52.250.07
60	52.260.01	52.260.02	52.260.03	52.260.04	52.260.05	52.260.06	52.260.07



	Fig.	mm Ø	
52.270.08	00	8	52.272.08
52.270.10	0	10	52.272.10
52.270.12	1	12	52.272.12
52.270.14	2	14	52.272.14
52.270.16	3	16	52.272.16
52.270.18	4	18	52.272.18
52.270.20	5	20	52.272.20
52.270.22	6	22	52.272.22
52.270.24	7	24	52.272.24
52.270.26	8	26	52.272.26
52.270.28	9	28	52.272.28
52.270.30	10	30	52.272.30

52.270.08-52.270.30

52.272.08-52.272.30

52.274.12

52.276.10