

Hirnnaht
 Brain Suture
 Suture cérébrale
 Sutura cerebral
 Sutura cerebrale

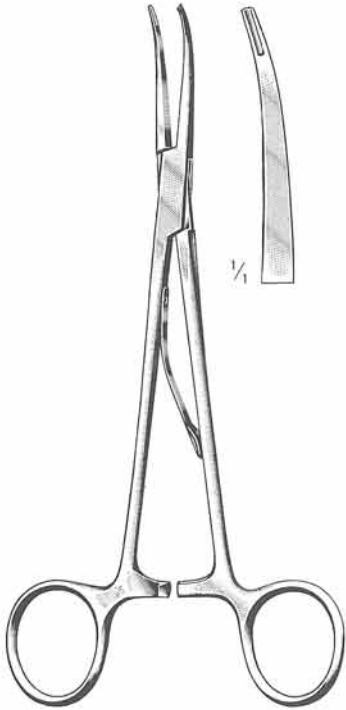

cm McKENZIE
 15 40.011.15
 19 40.011.19

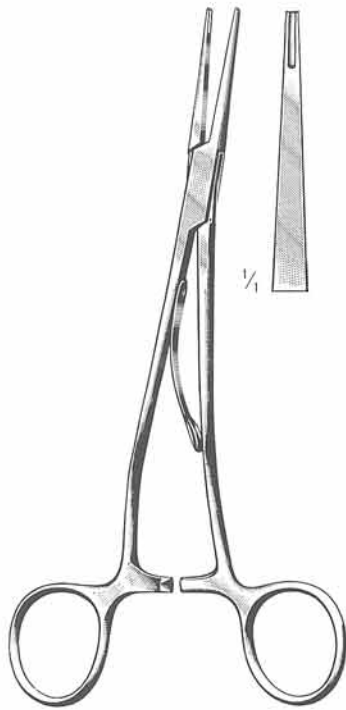

cm McKENZIE
 15 40.013.15
 19 40.013.19

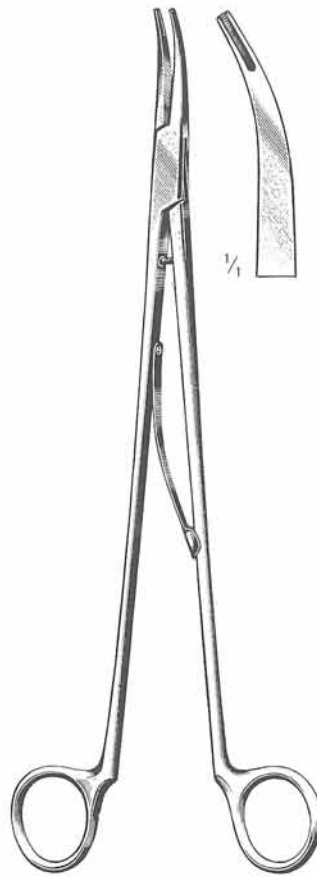

cm SMITHWICK
 23 40.015.23
 26 40.015.26

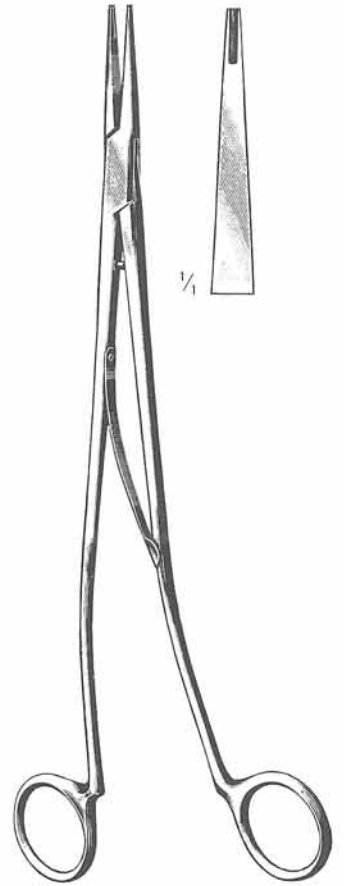

cm SWEET
 23 40.017.23
 26 40.017.26



OLIVECRONA-TOENNIS
 40.019.14



40.020.00
 148x40x6 mm

Schädelhalter
 Cervical Traction Tongs
 Pinces de traction crânienne
 Pinzas de tracción craneal
 Pinze per trazione craniale

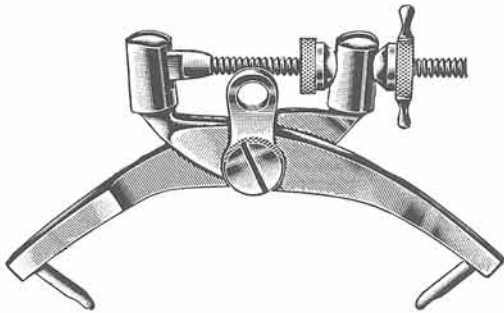

CRUTCHFIELD
 40.025.01



CRUTCHFIELD
 40.025.02



40.026.35
 3,5 mm Ø



40.026.50
 5 mm Ø

Kopfhautklammer, -anlegezange
 Scalp Hemostasis Clip, Applying Forceps
 Pince hémostatique pour le cuir chevelu, pince à poser
 Pinza hemostática para cuero cabelludo, pinza para poner
 Pinza emostatica per il cuoio capelluto, pinza per applicare e togliere



RANEY
 40.027.00

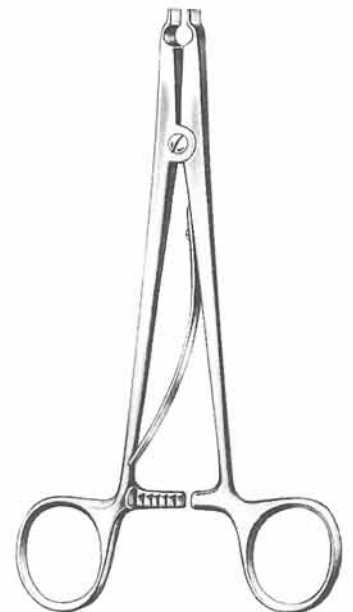

RANEY
 40.028.00

Nervhaken
 Nerve Retractors
 Ecarteurs à nerfs
 Separadores para nervios
 Divaricatori per nervi

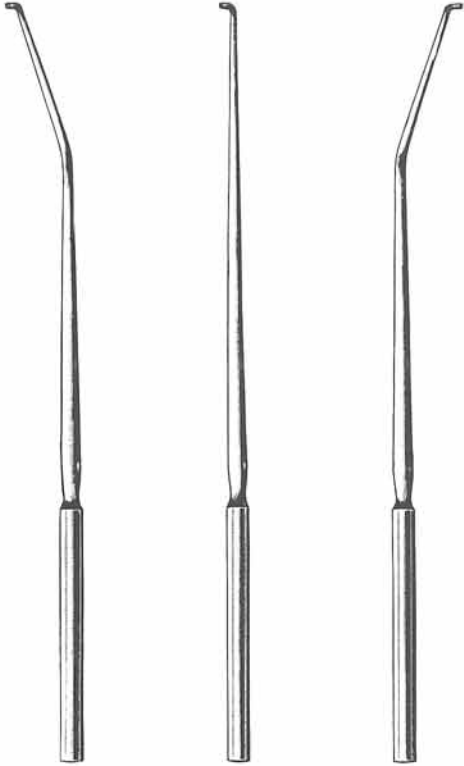

DANDY
 40.051.20
 20 cm

DANDY
 40.052.20
 20 cm

DANDY
 40.053.20
 20 cm



CUSHING
 40.056.28
 28 cm

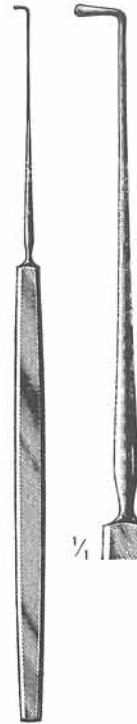

CUSHING
 40.058.28
 28 cm



GRAHAM
 40.061.16
 16,5 cm



SACHS
 40.064.18
 18,5 cm



ADSON
 40.068.20
 20 cm



ADSON
 40.069.20
 20 cm



SMITHWICK
 40.070.29
 29 cm

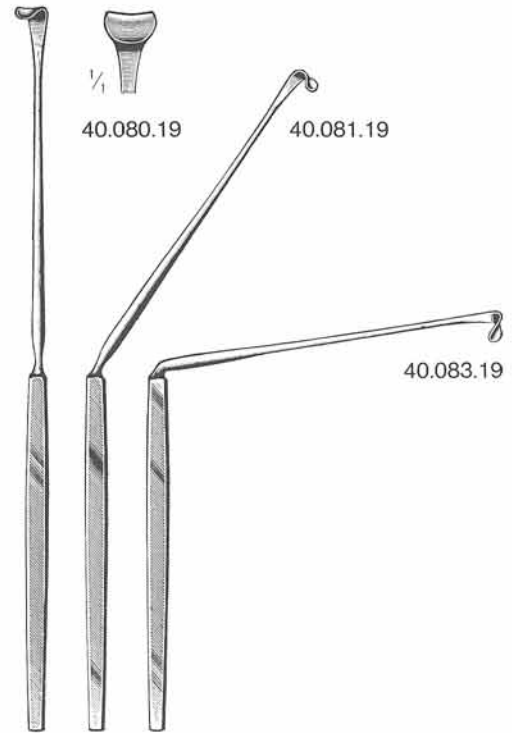

LOVE
 40.080.19-40.083.19

Neurochirurgie
 Neurosurgery
 Neurochirurgie
 Neurocirugía
 Neurochirurgia



De MARTEL
 40.090.33
 33 cm

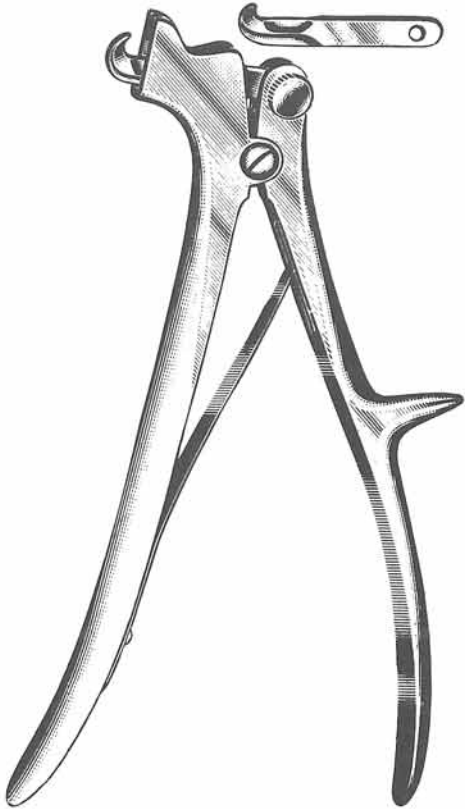

De VILBISS
 40.096.21
 21 cm



cm	OLIVECRONA
30	40.092.30
40	40.092.40
50	40.092.50
60	40.092.60
70	40.092.70



GIGLI
 40.094.00

Dura-Dissektoren · Dura Dissectors · Dissecteurs à duremère
 Descoladores para la duramadre · Scollatori per la duramadre

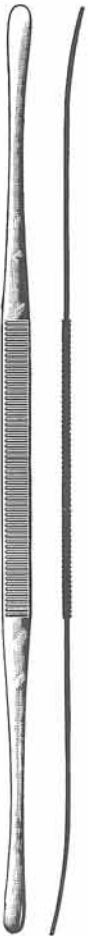

TOENNIS
 40.141.25
 25 cm



SACHS
 40.143.21

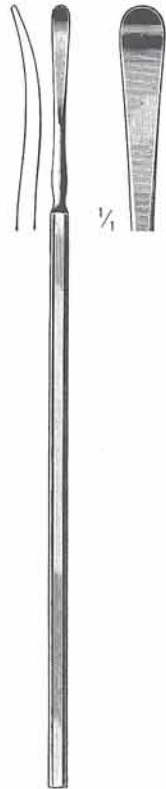

SACHS
 40.145.21



MILLIGAN
 40.147.21

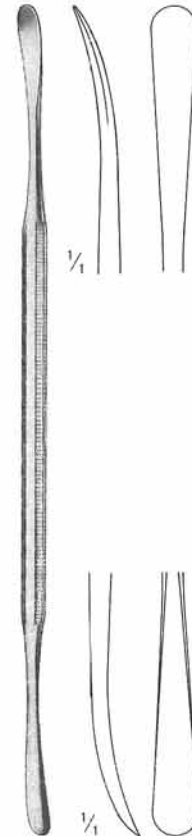

40.149.22

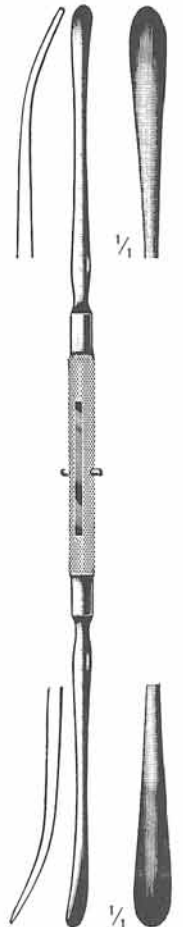

DAVIS
 40.151.24

Neurochirurgie
 Neurosurgery
 Neurochirurgie
 Neurocirugía
 Neurochirurgia

Dura-Dissektoren, -Messer
 Dura Dissectors, Knife
 Dissecteurs, bistouri à duremère
 Descoladores, bisturi para duramadre
 Scollatori, bisturi per duramadre

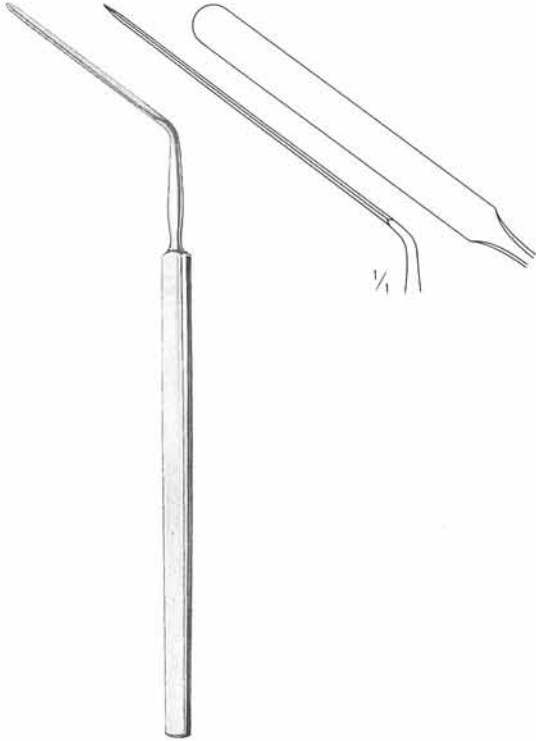

HORSLEY
 40.155.20
 20 cm



PENFIELD
 40.161.01
 17,5 cm



PENFIELD
 40.161.02
 19,5 cm



PENFIELD
 40.161.03
 19,5 cm



HALLE
 40.170.20

Hypophysenpinzetten · Hypophyseal Forceps · Pinces à hypophyse · Pinzas para hipófisis · Pinze per ipofisi



ADSON
 40.210.23



ADSON
 40.211.23



ADSON
 40.213.23

Hirnspatel, Saugrohre
 Brain Spatulas, Aspir. Tubes
 Spatules cérébr., tubes d'aspir.
 Espátulas cerebr., tubos de aspir.
 Spatole cerebr., tubi per aspiraz.



mm CUSHING
 7/ 9 40.250.07
 11/13 40.250.11
 15/18 40.250.15
 18/22 40.250.18
 180 mm

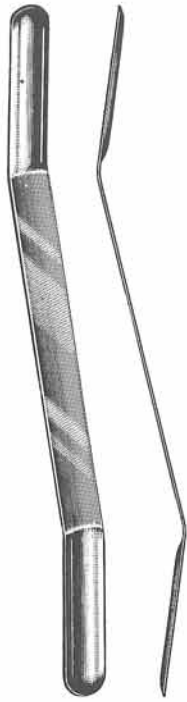

mm OLIVECRONA
 7/ 9 40.253.07
 11/13 40.253.11
 15/18 40.253.15
 18/22 40.253.18
 180 mm



mm HEIFETZ
 8 40.260.08
 11 40.260.11
 14 40.260.14
 17 40.260.17



ADSON
 40.290.21
 21 cm/4 mm

Charr. F.G.	↘	
	30°	75°
6	40.295.06	40.297.06
7	40.295.07	40.297.07
8	40.295.08	40.297.08
9	40.295.09	40.297.09
10	40.295.10	40.297.10
11	40.295.11	40.297.11
12	40.295.12	40.297.12
15	40.295.15	40.297.15



FRAZIER
 40.295.06-40.297.12
 19 cm

Wirbelkörperspreizer · Lamina Spreaders ·
 Ecarteurs pour corps vertébraux ·
 Separadores para cuerpos vertebrales ·
 Divaricatori per corpi vertebrali



FRAZIER
 40.298.12
 12 cm/3 mm



CLOWARD
 40.401.16



INGE
 40.405.17-40.405.27

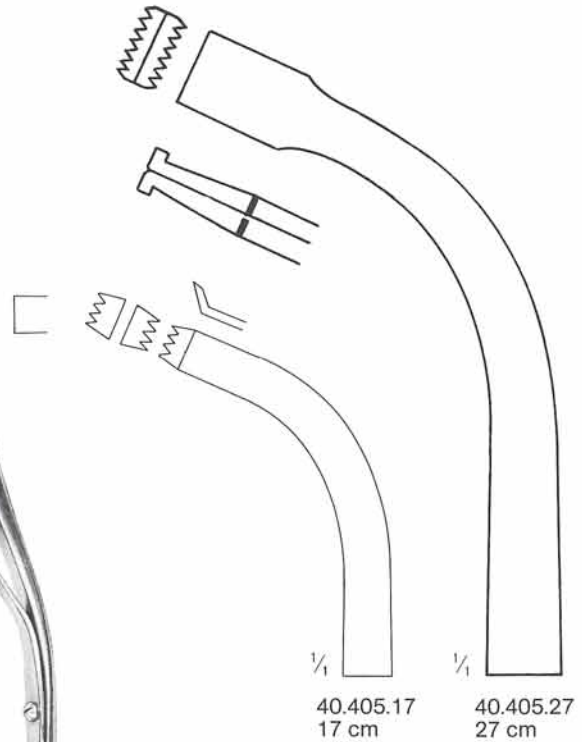

1/1
 40.405.17
 17 cm

1/1
 40.405.27
 27 cm

Laminektomie
Laminectomy
Laminectomie
Laminectomía
Laminectomia

Laminektomie-Zangen
Laminectomy Rongeurs
Pinces emporte-pièce à laminectomie
Pinzas cortantes para laminectomía
Pinze taglianti per laminectomia

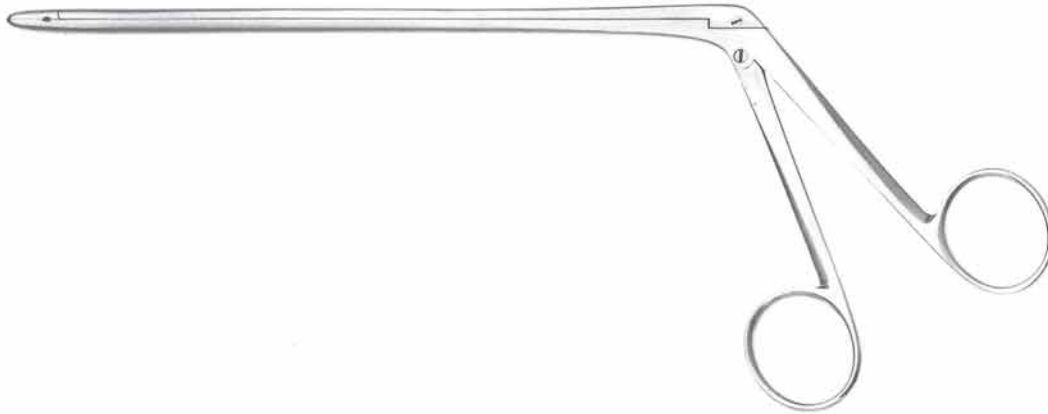

CUSHING
2 mm

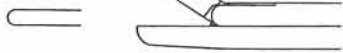

2 x 10 mm	L
40.420.01	12,5 cm
40.422.01	18,0 cm



2 x 10 mm / 45°	L
40.420.02	12,5 cm
40.422.02	18,0 cm

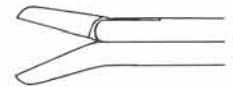

2 x 10 mm / 45°	L
40.420.03	12,5 cm
40.422.03	18,0 cm

LOVE-GRUENWALD
3 mm



3 x 10 mm	L
40.430.01	12,5 cm
40.432.01	18,0 cm



3 x 10 mm / 45°	L
40.430.02	12,5 cm
40.432.02	18,0 cm

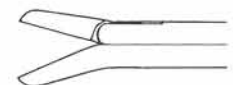

3 x 10 mm / 45°	L
40.430.03	12,5 cm
40.432.03	18,0 cm

SPURLING
4 mm



4 x 10 mm	L
40.440.01	12,5 cm
40.442.01	18,0 cm



4 x 10 mm / 45°	L
40.440.02	12,5 cm
40.442.02	18,0 cm

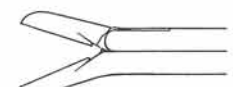

4 x 10 mm / 45°	L
40.440.03	12,5 cm
40.442.03	18,0 cm

Laminektomie-Zangen
 Laminectomy Rongeurs
 Pincas emporte-pièce à laminectomie
 Pinzas cortantes para laminectomía
 Pinze taglianti per laminectomia

Laminektomie
 Laminectomy
 Laminectomie
 Laminectomía
 Laminectomia

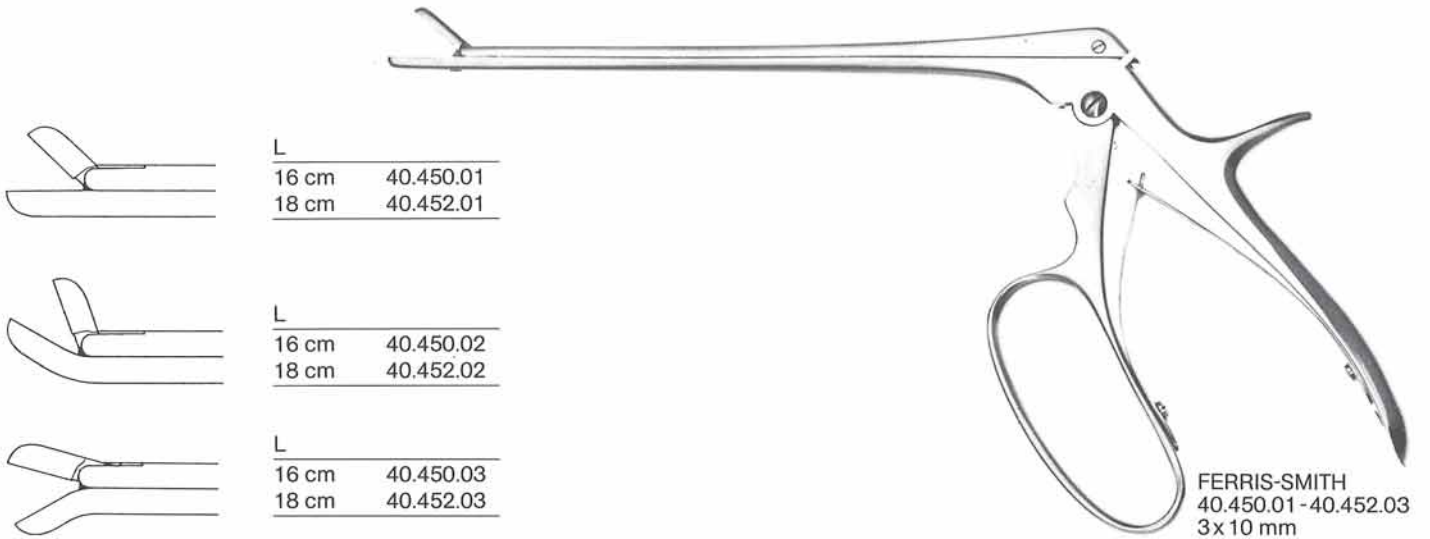
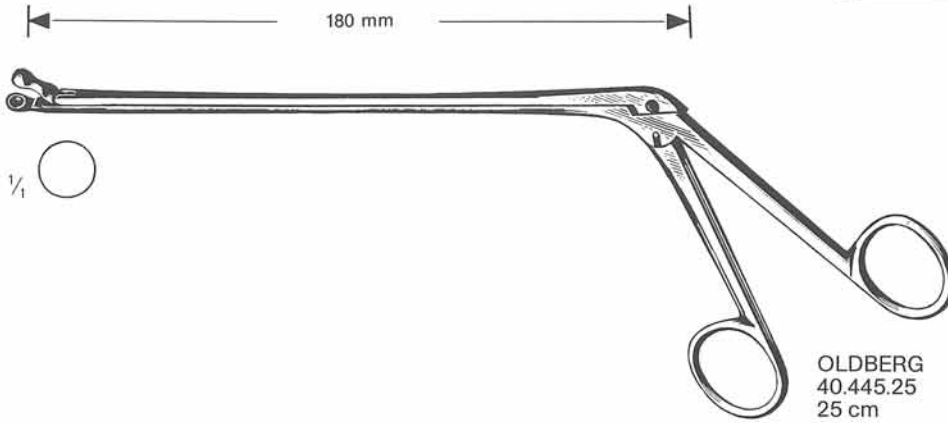

Laminektomie
Laminectomy
Laminectomie
Laminectomía
Laminectomia

Bandscheiben-Stanzen
Intervertebral Disc Rongeurs
Pinces emporte-pièce pour lames intervertébrales
Pinzas sacabocado para discos intervertebrales
Pinze taglianti per dischi intervertebrali

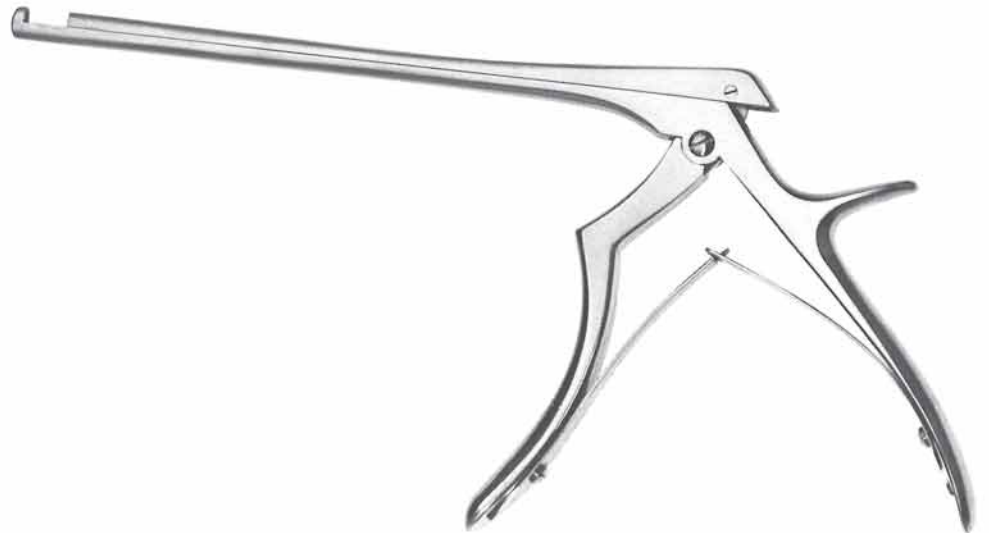

FERRIS-SMITH-KERRISON
40.510.01-40.512.05
18 cm

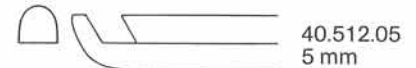
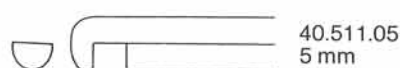
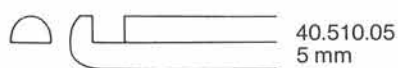
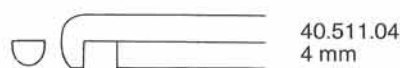
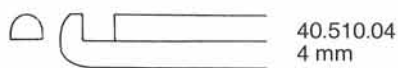
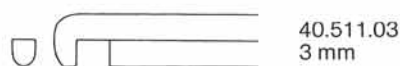
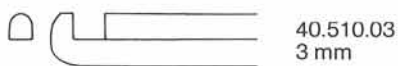
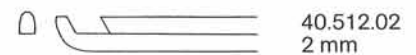
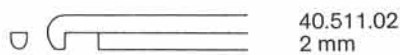
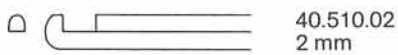
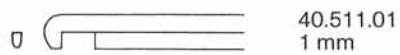
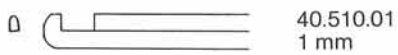

Bandscheiben-Stanzen
 Intervertebral Disc Rongeurs
 Pincas emporte-pièce pour lames intervertébrales
 Pinzas sacabocado para discos intervertebrales
 Pinze taglienti per dischi intervertebrali

Laminektomie
 Laminectomy
 Laminectomie
 Laminectomía
 Laminectomia

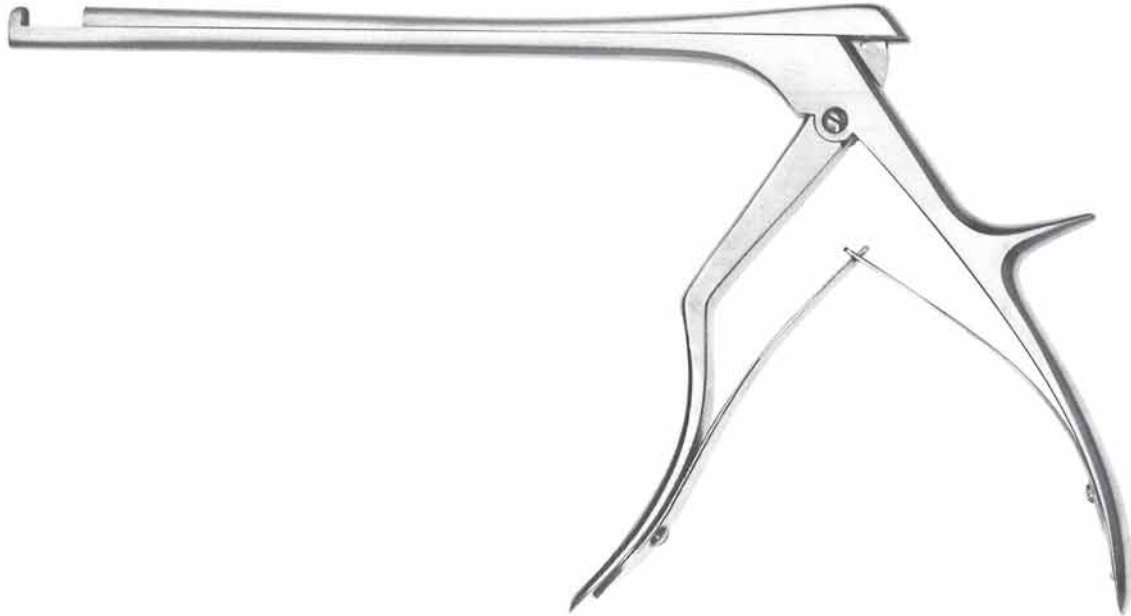



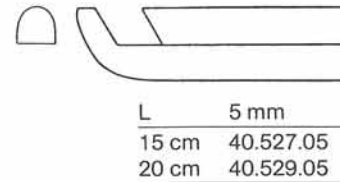
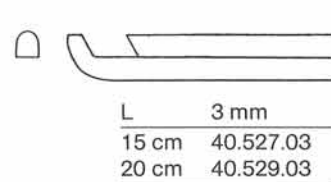
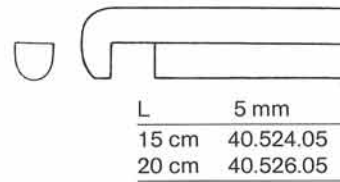
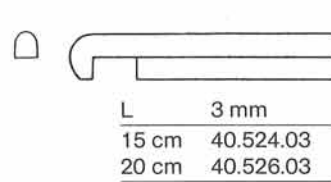
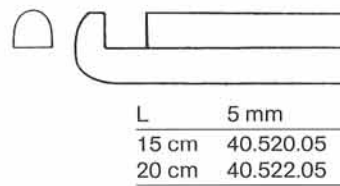
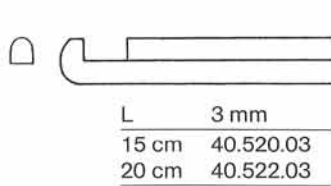













COLCLOUGH
 40.520.03-40.525.05



Neuro-, Gefäßchirurgie
 Neuro, Vascular Surgery
 Neurochir., Chir. vascul.
 Neurocir., Cir. vascular
 Neurochir., Chir. vascolare

Temporäre Clips = vergoldete Federenden
 Temporary Clips = gold plated spring ends
 Clips temporaires = bouts des ressorts dorés
 Clips temporarios = extremos de los resortes dorados
 Clips temporari = estremo della molla dorato

Clips „Mini“

MINI 	permanent				temporary				
		Maulöffnung Opening Ouverture Abertura Apertura	Maullänge Length of Jaws Longueur des mors Largo de la boca Lunghezza dei morsi	Schließkraft Closing Force Force de fermeture Fuerza de compresión Forza di compressione		Maulöffnung Opening Ouverture Abertura Apertura	Maullänge Length of Jaws Longueur des mors Largo de la boca Lunghezza dei morsi	Schließkraft Closing Force Force de fermeture Fuerza de compresión Forza di compressione	
	40.570.30	3,0 mm	3 mm	100-130 g (0,98-1,28 N)	40.571.30	3,0 mm	3 mm	35-45 g (0,34-0,44 N)	
	40.572.30	3,0 mm	3 mm						
	40.580.35	3,5 mm	5 mm		40.581.35	3,5 mm	5 mm		
	40.582.35	3,5 mm	5 mm		40.583.35	3,5 mm	5 mm		
	40.584.33	3,3 mm	5 mm						
	40.690.30	3,0 mm	3 mm						
	40.692.35	3,5 mm	5 mm						
	40.694.35	3,5 mm	5 mm						
	40.696.33	3,3 mm	5 mm						
	40.698.30	3,0 mm	5 mm						
	40.710.40	4,0 mm	7 mm		40.711.40	4,0 mm	7 mm	40-50 g (0,39-0,49 N)	
	40.712.38	3,8 mm	7 mm		40.713.38	3,8 mm	7 mm		
	40.714.35	3,5 mm	7 mm		40.715.35	3,5 mm	7 mm		
	40.718.50	5,0 mm	7 mm	80-100 g (0,78-0,98 N)					
	40.766.40	4,0 mm	7 mm	100-130 g (0,98-1,28 N)					



















Anlegezangen · Applying Forceps · Pincers de pose · Pinzas de aplicación · Pinze per posizionare



f. p.
 MINI 40.772.21
 STANDARD 40.774.21
 21 cm

Clips „Standard“

Neuro-, Gefäßchirurgie
 Neuro, Vascular Surgery
 Neurochir., Chir. vascul.
 Neurocir., Cir. vascular
 Neurochir., Chir. vascolare

STANDARD		permanent				temporary			
		Maulöffnung Opening Ouverture Abertura Apertura	Maullänge Length of Jaws Longueur des mors Largo de la boca Lunghezza dei morsi	Schließkraft Closing Force Force de fermeture Fuerza de compresión Forza di compressione					
	40.720.55	5,5 mm	7 mm	110-140 g (1,08-1,37 N)					
	40.722.53	5,3 mm	7 mm						
	40.724.48	4,8 mm	7 mm						
	40.726.50	5,0 mm	7 mm						
	40.728.68	6,8 mm	7 mm						
	40.730.60	6,0 mm	9 mm						
	40.732.60	6,0 mm	9 mm						
	40.734.50	5,0 mm	9 mm						
	40.738.75	7,5 mm	9 mm						
	40.740.68	6,8 mm	11 mm						
	40.742.65	6,5 mm	11 mm	100-130 g (0,98-1,28 N)					
	40.744.58	5,8 mm	11 mm						
	40.750.80	8,0 mm	15 mm						
	40.752.75	7,5 mm	15 mm						
	40.754.65	6,5 mm	15 mm						
	40.770.68	6,8 mm	9 mm	110-140 g (1,08-1,37 N)	*PILOT- Clips				
	40.780.38	3,8 mm	7 mm						
									
