

Niere  
Kidney  
Rein  
Riñon  
Rene

Nierensteinzangen  
Kidney Stone Forceps  
Pincès à calculs renaux  
Pinzas para cálculos renales  
Pinze per calcoli renali

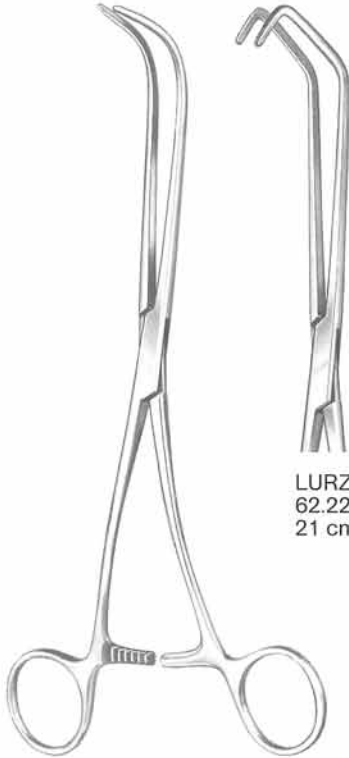

MAYO  
62.210.32  
32 cm



LURZ  
62.221.21  
21 cm

Ureterklemmen  
Ureter Clamps  
Pincès-clamps à urètere  
Pinzas clamps para ureter  
Pinze per uretere

LURZ  
62.223.21  
21 cm

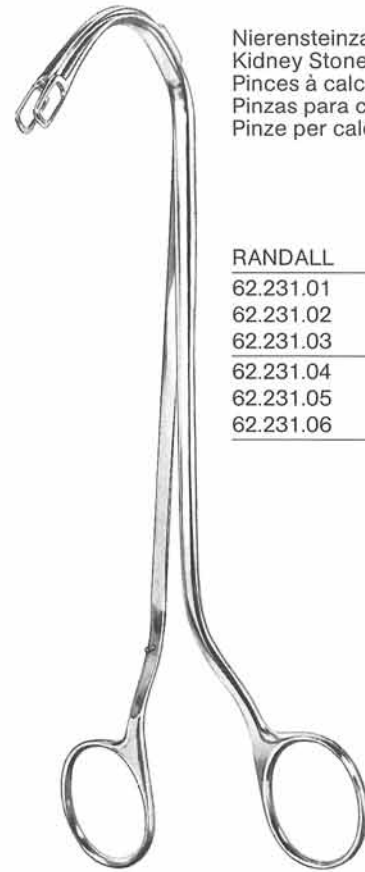

RANDALL  
62.231.01-62.231.06

RANDALL	Fig.	cm
62.231.01	1	23
62.231.02	2	22
62.231.03	3	22
62.231.04	4	22
62.231.05	5	19
62.231.06	6	19

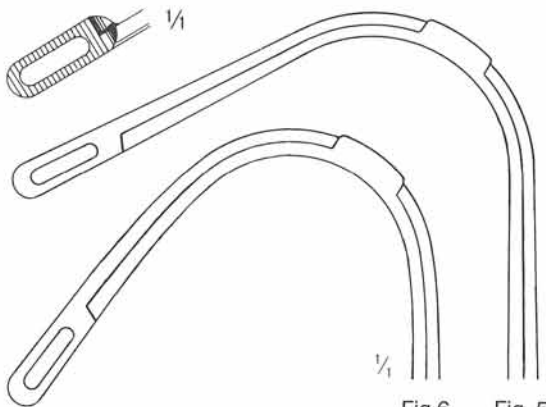

Fig.6 Fig. 5

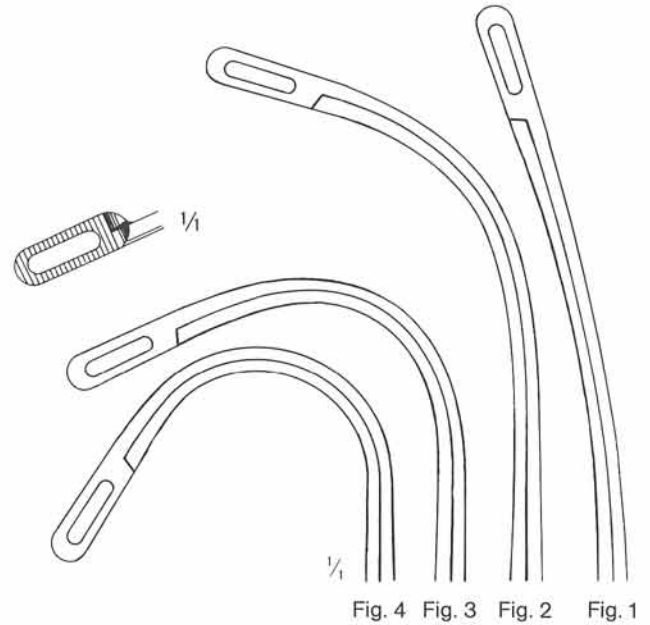
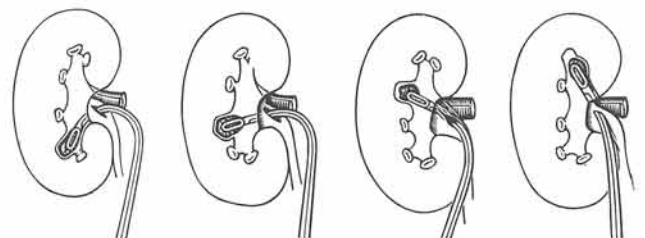

Fig. 4 Fig. 3 Fig. 2 Fig. 1

in situ:



5-6



4

3

2

1

Darm- und Gewebefäßzangen  
 Bowel and Tissue Grasping Forceps  
 Pincès à saisir les intestins et les tissus  
 Pinzas para coger intestinos y tejidos  
 Pinze per afferrare intestini e tessuti

Darm, Magen  
 Intestines and Stomach  
 Intestin, Estomac  
 Intestines, Estómago  
 Intestini, Stomaco

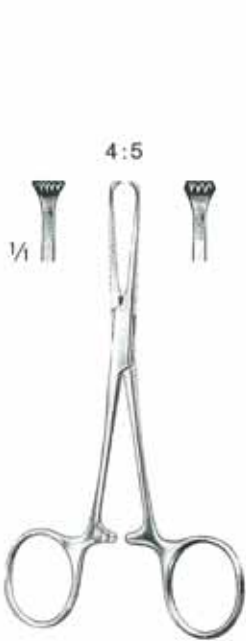

ALLIS-Baby  
 64.102.14  
 14 cm



4:5	ALLIS	5:6
64.110.15	15 cm	64.120.15
	19 cm	64.120.19
	22 cm	64.120.22
	24 cm	64.120.24

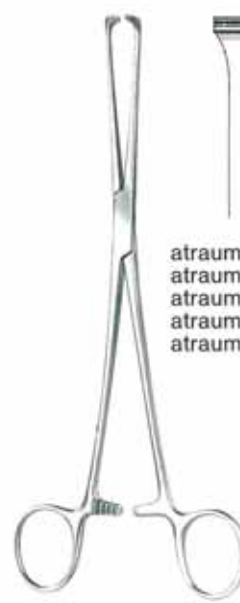

atraumatisch  
 atraumatic  
 atraumatique  
 atraumática  
 atraumatica

cm	ALLIS
16	64.124.16
20	64.124.20
25	64.124.25



ALLIS-ADAIR  
 64.130.15  
 15,5 cm



cm	JUDD-ALLIS
15	64.140.15
19	64.140.19



THOMS-ALLIS  
 64.150.20  
 20 cm

Mit TC-Einsätzen  
 TC Lined  
 A mors TC  
 Con bocas TC  
 Con morso TC



atraumatisch  
 atraumatic  
 atraumatique  
 atraumática  
 atraumatica

cm	BABCOCK	TC	
16	64.160.16	64.164.16	64.168.16
18	64.160.18		
20	64.160.20	64.164.20	64.168.20
24	64.160.24		

Darm, Magen  
 Intestines and Stomach  
 Intestin, Estomac  
 Intestines, Estómago  
 Intestini, Stomaco

Mit TC-Einsätzen  
 TC Lined  
 A mors TC  
 Con bocas TC  
 Con morso TC



DUVAL  
13 mm



DUVAL  
25 mm

cm	DUVAL 13 mm	DUVAL 25 mm
18	64.170.18	
20	64.170.20	64.172.20
20	64.174.20	
23		64.172.23



DUVAL  
64.170.18-64.174.20



WILLIAMS  
64.180.16  
16,5 cm



SCHOENBURG  
64.182.22  
22 cm

Darmklemmen  
 Intestinal Forceps  
 Pinces intestinales  
 Pinzas intestinales  
 Pinze intestinali



DOYEN  
DOYEN-Baby  
64.210.18-64.217.23

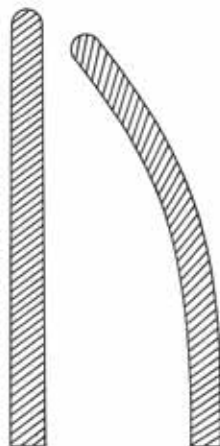

cm	DOYEN-Baby	
16		
18	64.210.18	64.211.18
21		
23		

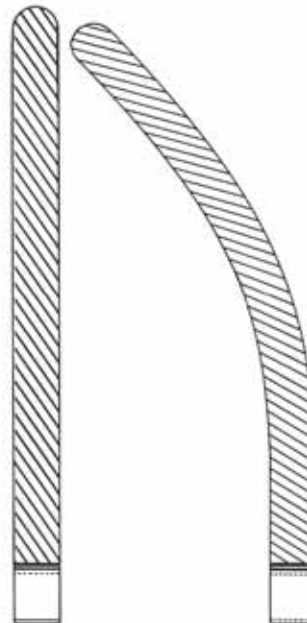

	DOYEN	
	64.210.21	64.211.21
	64.210.23	64.211.23

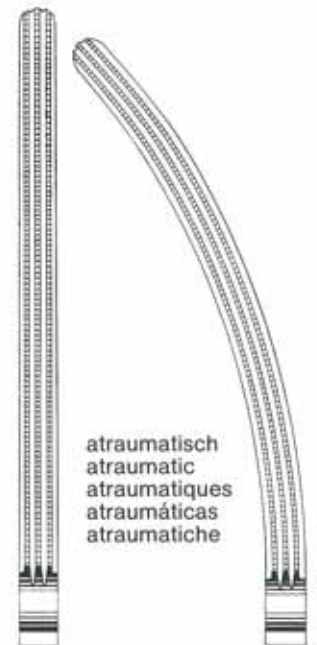

atraumatisch  
 atraumatic  
 atraumáticas  
 atraumatiche

	DOYEN	
	64.216.16	64.217.16
	64.216.18	64.217.18
	64.216.21	64.217.21
	64.216.23	64.217.23

Darmklemmen  
 Intestinal Forceps  
 Pincas intestinales  
 Pinzas intestinales  
 Pinze intestinali

Darm, Magen  
 Intestines and Stomach  
 Intestin, Estomac  
 Intestines, Estómago  
 Intestini, Stomaco

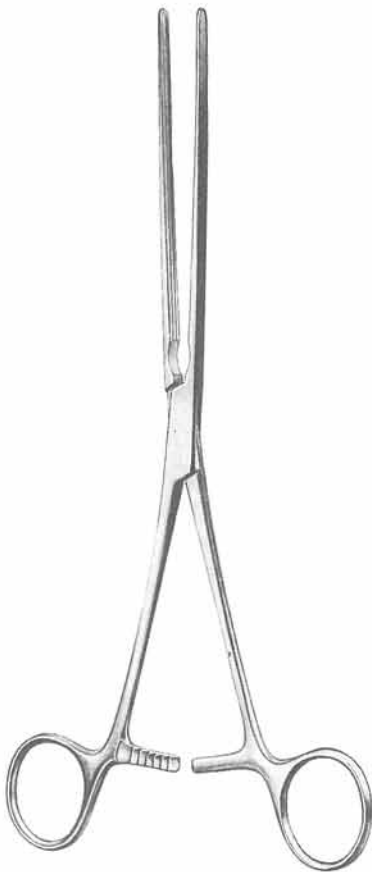

KOCHER  
 64.220.22-64.227.28

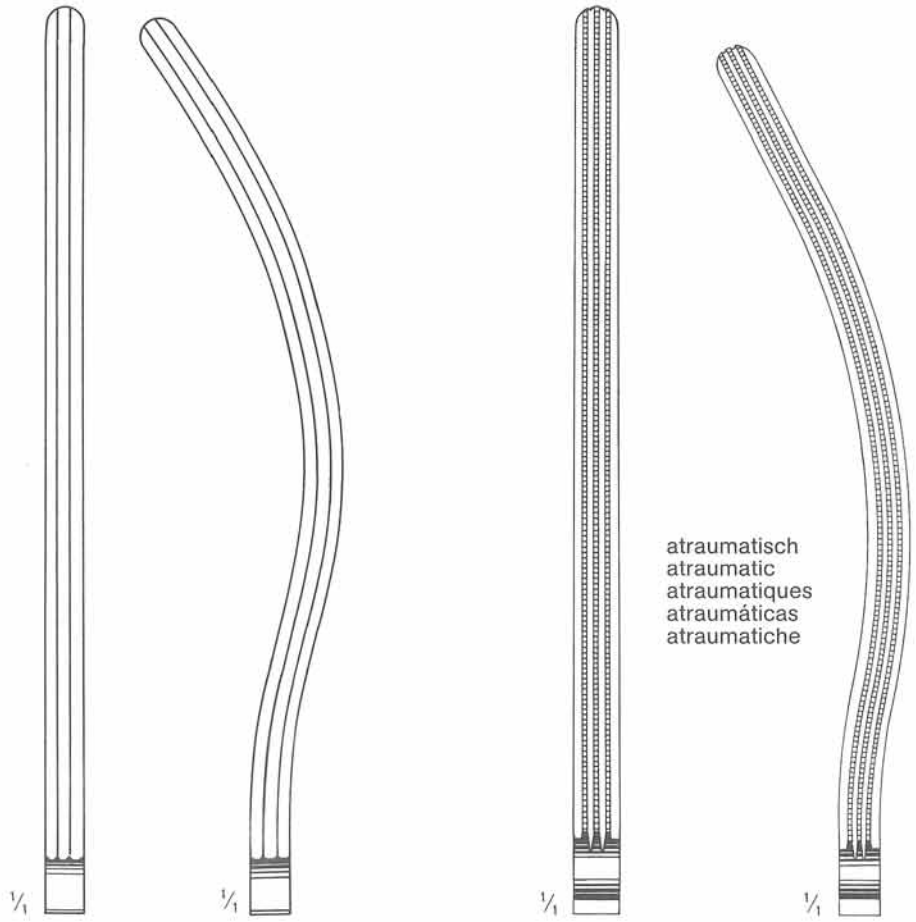

atraumatisch  
 atraumatic  
 atraumatiques  
 atraumáticas  
 atraumatiche

cm	KOCHER			
22	64.220.22	64.221.22	64.226.22	64.227.22
25	64.220.25	64.221.25	64.226.25	64.227.25
28	64.220.28	64.221.28	64.226.28	64.227.28

Darm, Magen  
 Intestines and Stomach  
 Intestin, Estomac  
 Intestines, Estómago  
 Intestini, Stomaco

Darmklemmen  
 Intestinal Forceps  
 Pincas intestinales  
 Pinzas intestinales  
 Pinze intestinali

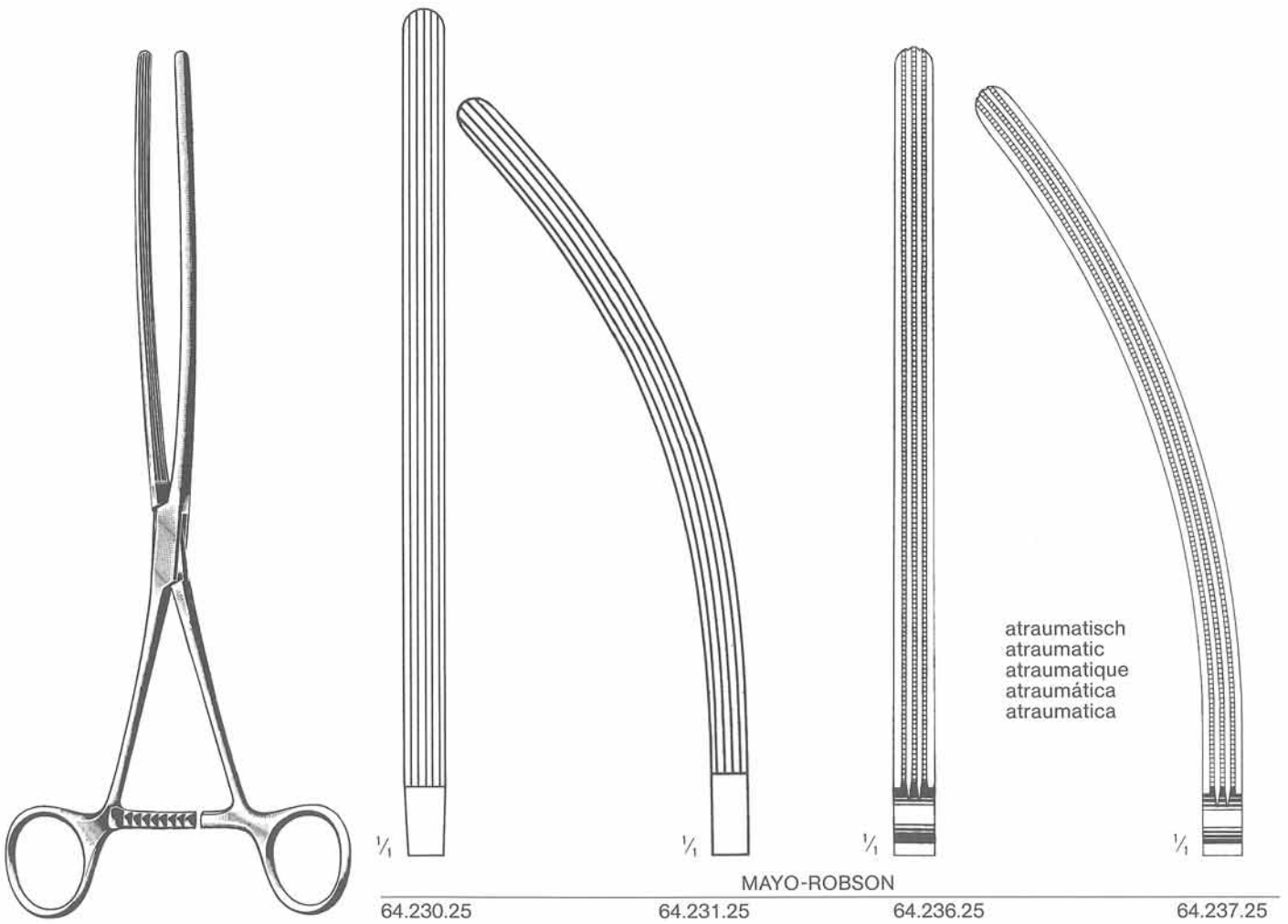

MAYO-ROBSON  
 64.230.25-64.237.25  
 25 cm

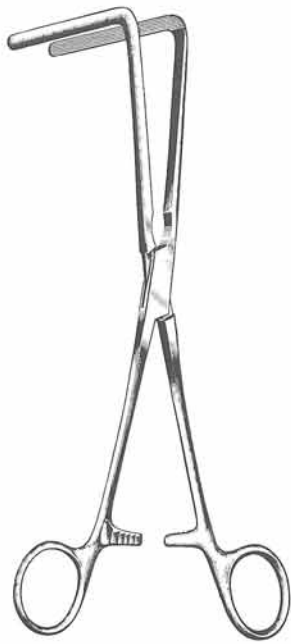

normal	FEHLAND	atraum.
64.241.23	23,5 cm	64.247.23

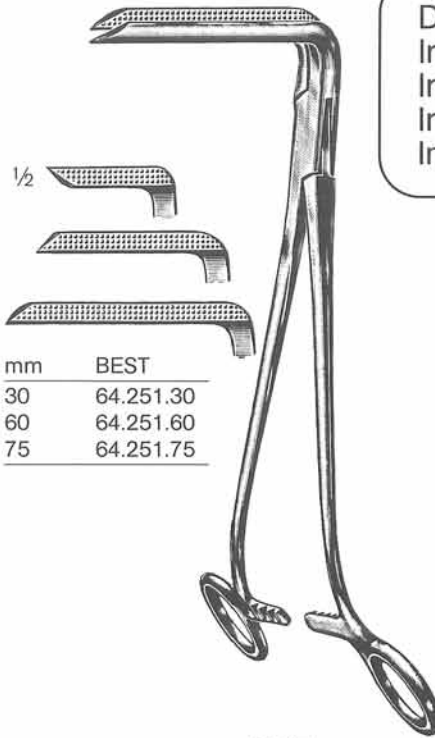

mm	BEST
30	64.251.30
60	64.251.60
75	64.251.75

BEST  
64.251.30-64.251.75  
26,5 cm

Darm, Magen  
Intestines and Stomach  
Intestin, Estomac  
Intestines, Estómago  
Intestini, Stomaco

Darm- und Magenklappen  
Intestinal and Stomach Clamps  
Pincas-clamps intestinales  
Pinzas-clamps intestinales y estomacales  
Pinze intestinali e stomacali



BRUNNER  
64.260.24-64.266.24  
24 cm

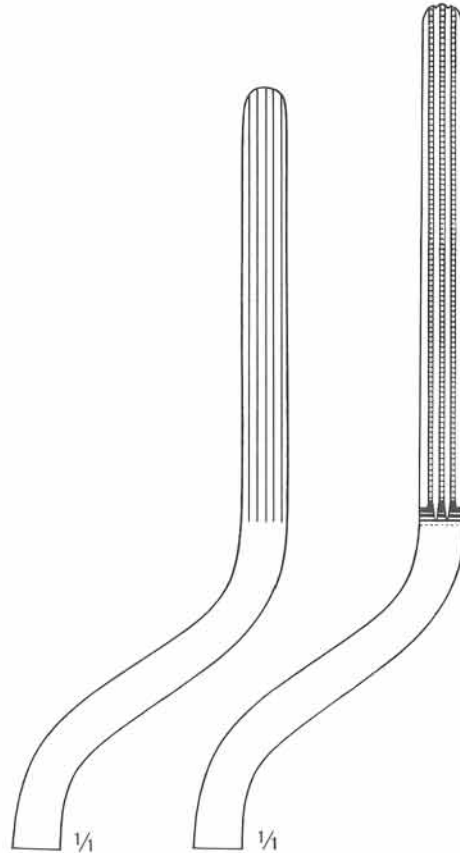

BRUNNER  
64.260.24      64.266.24

atraumatisch  
atraumatic  
atraumatique  
atraumática  
atraumatica

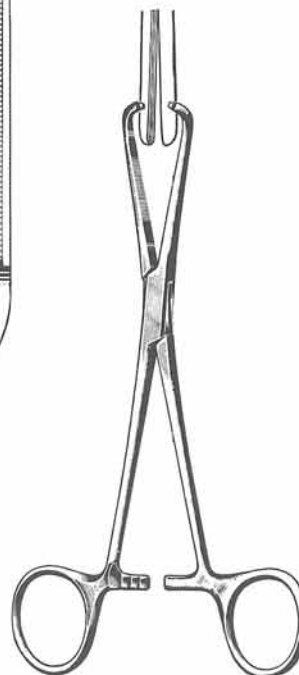

STONE  
64.270.15  
15,5 cm



STONE-WATT  
64.274.00



cm	STONE-WATT
7,5	64.272.07
10	64.272.10

Darm, Magen  
 Intestines and Stomach  
 Intestin, Estomac  
 Intestines, Estómago  
 Intestini, Stomaco

Anastomosenklemmen und Zubehör  
 Anastomosis Clamps and Accessories  
 Clamps à anastomose et accessoires  
 Clamps para anastomosis y accesorios  
 Pinze per anastomosi e accessori

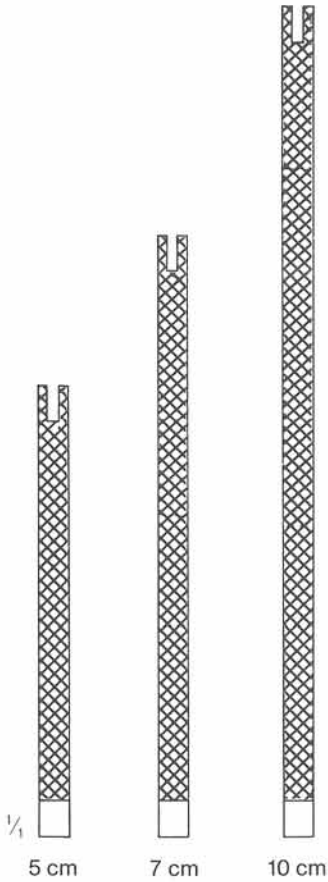

5 cm      7 cm      10 cm



cm	DE MARTEL-WOLFSON
5	64.280.05
7	64.280.07
10	64.280.10
Set /3	

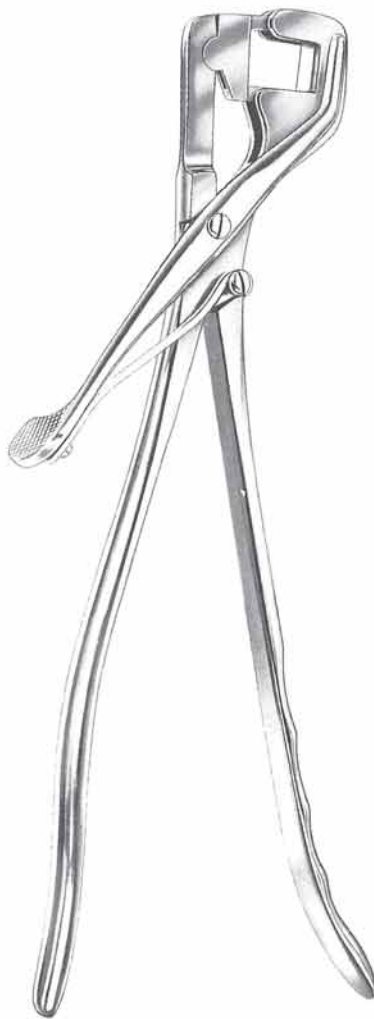

DE MARTEL-WOLFSON  
 64.282.26  
 26 cm

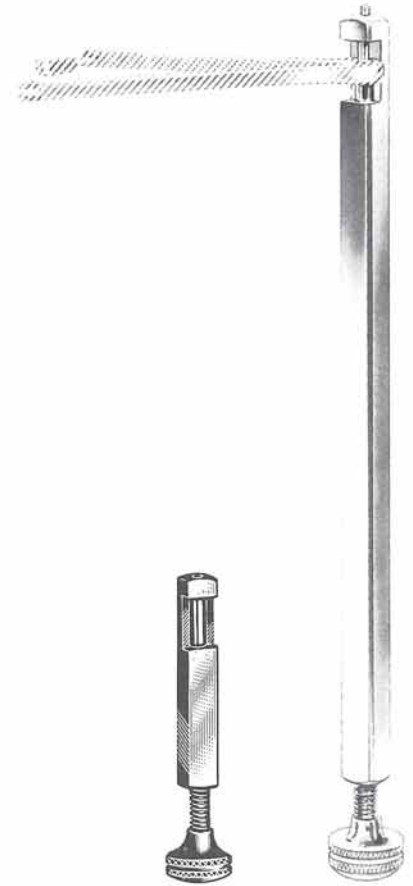

DE MARTEL-WOLFSON	
64.284.08	64.284.23
8,5 cm	23 cm

Magenklemmen  
Stomach Clamps  
Pincas-clamps stomacales  
Pinzas-clamps estomacales  
Pinze stomacali

Darm, Magen  
Intestines and Stomach  
Intestin, Estomac  
Intestines, Estómago  
Intestini, Stomaco

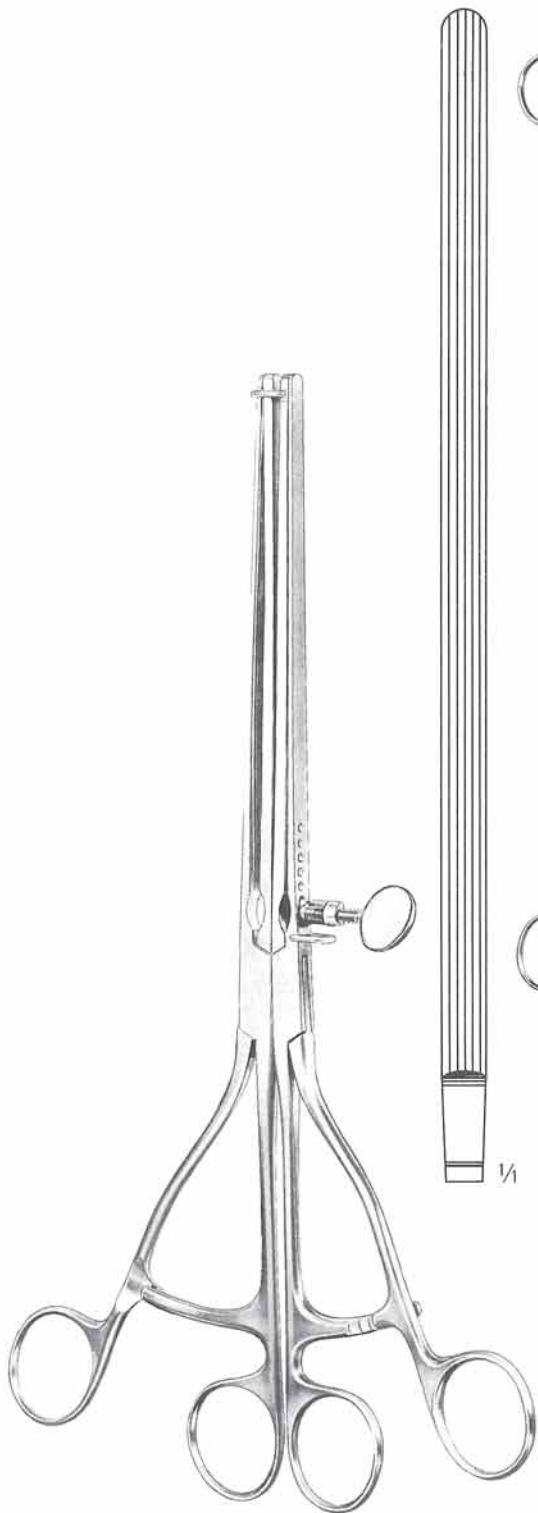

LANE  
64.290.30  
30 cm



LANE  
64.291.30  
30 cm



Darm, Magen  
 Intestines and Stomach  
 Intestin, Estomac  
 Intestines, Estómago  
 Intestini, Stomaco

Magenklemmen  
 Stomach Clamps  
 Pincas-clamps stomacales  
 Pinzas-clamps estomacales  
 Pinze stomacali

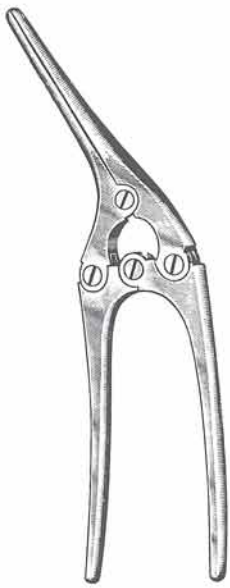

PAYR-Baby  
 64.310.15  
 15 cm

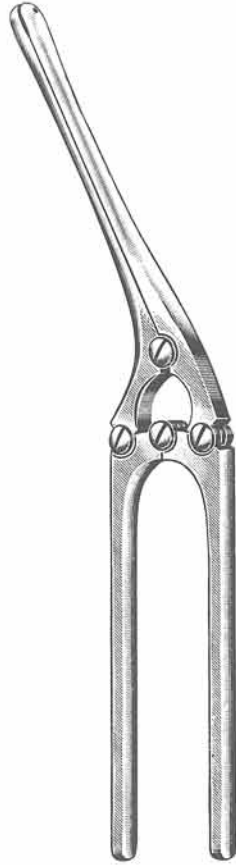

PAYR

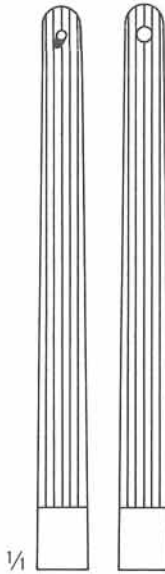

64.310.21  
 21 cm

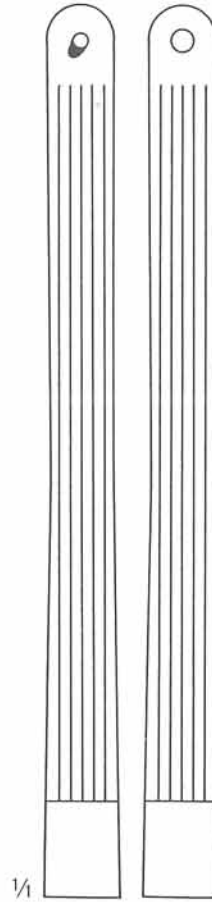

64.310.29  
 29 cm

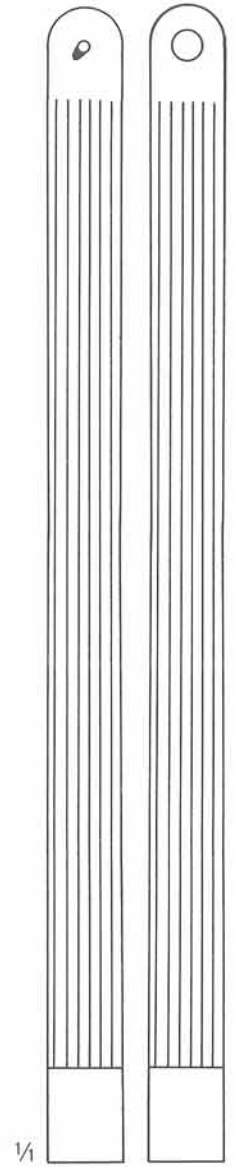

64.310.35  
 35 cm

Magen- und Darmnähhapparat · Stomach and Intestinal Suturing Apparatus · Appareil à sutures stomacales et intestinales · Aparato para suturas estomacales e intestinales · Apparecchio per suture stomacali e intestinali

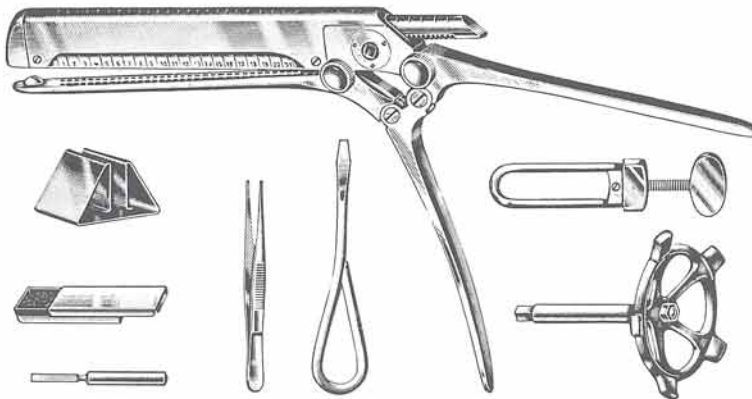

v. PETZ  
 64.320.00  
 compl.



300 Stück  
 300 ea.  
 300 pièces  
 300 c/u  
 300 pezzi

64.321.00